

Budapest University of Technology and Economics  
Institute of Mathematics  
Department of Stochastics

# Fractal Characterization of Complex Networks

MSc Thesis

Roland Molontay

Supervisor:

**Prof. Károly Simon**

Professor of Mathematics, Head of Department of Stochastics,  
Budapest University of Technology and Economics

2015

# Contents

<b>Acknowledgements</b>	<b>2</b>
<b>1 Introduction</b>	<b>3</b>
1.1 Network science and mathematics . . . . .	4
1.2 Definitions and notation . . . . .	6
<b>2 Fractality and self-similarity of complex networks</b>	<b>10</b>
2.1 Box covering and fractality . . . . .	11
2.2 Box-covering algorithm . . . . .	14
2.3 Renormalization and self-similarity . . . . .	18
2.4 Network dimensions and their connection . . . . .	21
2.5 Further network dimensions . . . . .	24
2.6 Origins and influence of fractality . . . . .	26
2.6.1 The “repulsion between hubs” principle . . . . .	26
2.6.2 Skeleton of complex networks . . . . .	33
2.6.3 Influence and importance of fractality . . . . .	35
<b>3 Fractal network models</b>	<b>38</b>
3.1 Song-Havlin-Makse-model . . . . .	38
3.2 $(u,v)$ -flowers and $-$ trees . . . . .	41
<b>4 Summary</b>	<b>47</b>
<b>Bibliography</b>	<b>55</b>

# Acknowledgements

First and foremost I would like to express my greatest gratitude to my supervisor, Prof. Károly Simon, without his kind help and invaluable advices I would not have been able to write my thesis. I have benefited greatly from his helpful comments and suggestions during the preparation of my thesis. I am thankful for his continuous assistance and tremendous support.

I am greatly indebted to Dr. Júlia Komjáthy, the co-supervisor of my BSc thesis, for introducing me to the world of network theory and also for her guidance during my MSc studies in spite of the fact that she moved to Eindhoven.

I am grateful to all of my teachers who helped me throughout my academic progress. A special thank of mine goes to my secondary school math teacher, Helga Kertai whose way of teaching inspired me to study mathematics.

Finally, I owe a great debt of gratitude to my family for their understanding and support all over the years.

# Chapter 1

## Introduction

Complex networks have been studied extensively since they describe efficiently a wide range of systems, spanning many different disciplines, such as Biology (e.g. protein interaction networks), Information Technology (e.g. World Wide Web, Internet), Social Sciences (e.g. scientific collaboration networks, human communication networks) etc. Accordingly, networks are ubiquitous in science and in everyday life and have been the focus of intense interest since they can represent various systems in a tractable way. Characterizing the topology of networks is very important for a wide range of static and dynamic properties (e.g. the topology of social networks influences the spread of information and disease).

One of the most important discoveries is that despite of the diversity of networks, most real-world networks share specific properties that differ in many ways from random networks (such as Erdős-Rényi random graph [19]). Two fundamental characteristics of complex networks that have attracted tremendous attention recently are the small-world property and the scale-free property. Small-world behavior means that the average distance between vertices scales logarithmically with the number of nodes [68]; while scale-free property refers to the fact that the degree distribution follows a power law [2].

Other fundamental properties, which are in the focus of this thesis, are self-similarity and fractality. To put it in other words, we investigate whether

the whole network looks much the same as a subsection of itself. Although there is no distinction between fractality and self-similarity with respect to regular fractal objects, in network theory we can distinguish the two terms: the fractality stands for the power-law relation between the minimum number of boxes needed to cover the entire network and the size of the boxes, while a self-similar network is defined as a network whose degree distribution is invariant under renormalization (details will be provided later) [60].

My BSc thesis [47] is also devoted to network theory, the reader can find there a much more detailed introduction to the field with historical overview, several real-world examples, lots of interesting facts, basic definitions and a number of mathematical models. The necessary notions are also repeated in this work.

In this thesis we will unfold the concepts of fractality and self-similarity, we review some notions of fractal dimension and the connections between them. If needed, we handle the lack of mathematically rigorous notions of the current literature and make concepts and proofs more precise. We study the origin and influence of fractality, observe some real-world examples, show and investigate some mathematical models.

## 1.1 Network science and mathematics

In recent years network science has become a new discipline of great importance. It can be regarded as a new academic field since 2005 when the United States National Research Council defined network science as a new field of basic research [14]. The most distinguished academic publishing companies announce the launch of new journals devoted to complex networks, one after another (e.g. Journal of Complex Network by Oxford University Press <sup>1</sup> or Network Science by Cambridge University Press <sup>2</sup>). Leading universities also continuously establish research centers for network science, such as

---

<sup>1</sup><http://comnet.oxfordjournals.org/>

<sup>2</sup><http://journals.cambridge.org/NWS>

Yale University <sup>3</sup>, Duke University <sup>4</sup>, Northeastern University <sup>5</sup> or Central European University <sup>6</sup>, the last two have also launched PhD programs in the field recently. The significance of network theory is also reflected in the big number of publications about complex networks and in the enormous number of citations of the pioneering papers by Barabási & Albert [2] and Watts & Strogatz [68] that turned the attention to complex networks. Some scientists interpret network science as a new paradigm shift [32], however, complex networks did not only influence the research community, but also appeared in popular literature [3], [67] and mass media <sup>7</sup>.

Complex networks are researched by several disparate disciplines, mathematicians (primarily graph theorists and probabilists) also extensively study networks [8], [41], [64]. Mathematicians sometimes have hard time dealing with network science since it is mainly researched from an empirical perspective, without mathematical rigor, but with notions based on simulations. It is also important to mention some of the criticism leveled at network science. Some articles question the ubiquity of scale-free property and confute the assumption that biological networks or the internet are scale-free [37], [63], [69]. These papers claim that in most of the network science literature the data are typically insufficient and the measurements are not of satisfactory quality for the aim they are used for, furthermore there are no careful statistical tests [62]. The critics also lack that network scientists usually provide no statistically clean separation between the data used for model selection and for model validation. It is also under criticism that lots of assertions are obtained by plotting and fitting, e.g. creating log-log plots of degree vs. frequency and fitting a straight line. However, doubters highlight that commonly used methods, such as least-squares fitting, can provide considerably inaccurate estimates of parameters [13]. On the other hand, it is worth ascertaining that none of the critics doubt the importance of the study of complex networks, just raise concerns about certain methods and statements.

---

<sup>3</sup><http://yins.yale.edu/>

<sup>4</sup><https://dnac.ssri.duke.edu/>

<sup>5</sup><http://www.barabasilab.com/>

<sup>6</sup><http://cns.ceu.edu/>

<sup>7</sup><http://www.imdb.com/title/tt1310375/>

Network theory keeps great potential for mathematics, with several outstanding mathematical challenges. In order to resolve the existing ambiguity in the field's mathematical formulation, lots of distinguished mathematicians have put on mathematically solid footing: developing the theory of scale-free random graphs [8], [7], establishing a theory of graph sequences and graph limits [41], [9], working out the precise concepts in theory of scale-free graphs [36] or laying down the mathematical foundations of random network models [64]. Nevertheless, one can argue that the mathematically rigorous concepts and theories sometimes do not meet the real interest of network scientists, e.g. most of the theories are developed for graphs tending to infinity, but network scientists are more interested in real-world networks (which are certainly of finite nodes).

It is also important to note that both in the general literature and in this work in most cases “network” and “graph” are interchangeable concepts. We usually use “network” if we would like to emphasize its real-world nature and “graph” if its mathematical properties are under consideration.

In this thesis we overview a certain segment of network science, namely the theory of fractal networks, we point out some mathematical inaccuracy and propose some ideas to make concepts more precise. We also derive some results with more rigor (such as Lemmas 2.8, 2.9, 3.1 and 3.2). On the other hand, this work does not intend to construct the complete mathematical theory of fractal networks, it would go far beyond the scope of this thesis.

## 1.2 Definitions and notation

In this section we introduce the most important definitions of network theory and fix the notation used throughout this paper. Having regard to the fact that a network stands for a system that can be modeled by a graph (an undirected single graph in most cases), the notions of network theory roots in graph theory. We assume the reader to be familiar with the basic concepts and results of graph theory. An overview over this topic can be found in my BSc thesis [47] or in [10]. However, we give a glossary which introduces the specific network theory vocabulary used in this paper. This topic is very

fresh and researched mainly empirically from a more practical point of view by scientists from several disciplines, hence the definitions are not always precise in a mathematical sense and sometimes the terminology is not even consequent in the papers. In this glossary and throughout this thesis we strive to use the most accurate notions and even try to make them more rigorous if necessary. Here we largely rely on [10], [66] and [51].

- A *graph* is an ordered pair  $G = (V, E)$ , where  $V$  is the set of vertices or nodes together with a set  $E$  of edges or links, which are two-element subsets of  $V$ . To be more precise, this is the definition of undirected and simple graph, since it does not allow either loops (self-edges) or multiple edges between elements of  $V$ . We note here that sometimes the vertex (node) set is denoted by  $N$ .
- A *path* is a sequence of edges such that the target of the previous edge is the source of the next edge. The length of a path is the number of its edges.
- A path is *geodesic* if its end points cannot be connected by shorter path.
- The length of a geodesic between two vertices  $u$  and  $v$  is the *distance*  $d(u, v)$  of these vertices.
- The  *$l$ -neighborhood*  $\Gamma_u^l$  of a vertex  $u$  is the set of vertices  $v$  whose distance from  $u$  is not greater than  $l$ .
- We write  $\text{Diam}(G)$  (*diameter*) for the maximal graph-distance in the graph  $G$  within components of  $G$ . It is not hard to see that  $\text{Diam}(G) \leq |V| - 1$ .
- The *characteristic path length*  $\ell$  is defined as the number of edges in the shortest path between two vertices, averaged over all pairs of vertices (mean of geodesic length):

$$\ell = \frac{1}{|V|(|V| - 1)} \sum_{u, v \in V, u \neq v} d(u, v) \quad (1.1)$$



The above definition only makes sense for connected graphs. If there are disconnected components, then  $\ell$  diverges. This may be adapted by averaging only over connected components or limiting the summation only to the pairs of vertices belonging to the largest connected component [68].

- Given two variables  $x$  and  $y$ ,  $y$  is directly *proportional* to  $x$  if there is a non-zero constant  $C$  such that  $y = Cx$ . In this paper sometimes we denote this relation by  $x \propto y$  or by  $x \approx y$ .
- A network is called *small-world* if the characteristic path length  $\ell$  grows proportionally to the logarithm of the number of nodes in the network, i.e.  $\ell \propto \log |V|$ .
- The *degree distribution*  $P(k)$  is the probability that the degree of a randomly (uniformly) chosen vertex is equal to  $k$ .
- A network is *scale-free* if its degree distribution follows a power law, i.e.  $P(k)$  is proportional to a power of  $k$ , for some number  $\gamma \geq 1$ :

$$P(k) \propto k^{-\gamma}. \tag{1.2}$$

Even though a lot of times not stated explicitly, in most cases the power law behavior is required only in the tail distribution, i.e. for  $k \geq k_0$ . For real networks the degree exponent  $\gamma$  usually satisfies  $2 < \gamma < 3$ .

The above definition of scale-free property is widely spread among network scientists, however it is not rigorous from a mathematical point of view. Here we give a more sophisticated - yet weaker - formulation [64]. First, we introduce the notion of graph sequence. Several real-world networks (collaboration networks, WWW) grow in size as time proceeds, therefore it is reasonable to consider graphs of growing size, namely graph sequences, denoted by  $\{G_n\}_{n \in \mathbb{N}}$ . We start by defining what it means for a graph process  $\{G_n\}_{n \in \mathbb{N}}$  to be sparse [64]:

**Definition 1.1.** Denote the proportion of vertices with degree  $k$  in  $G_n$  by  $P_k^n$ . A graph sequence  $\{G_n\}_{n \in \mathbb{N}}$  is called sparse when

$$\lim_{n \rightarrow \infty} P_k^n = p_k, \quad (1.3)$$

for some deterministic limiting distribution.

Now we can define the notion of scale-free graph sequences [64]:

**Definition 1.2.** We call a graph sequence  $\{G_n\}_{n \in \mathbb{N}}$  scale-free with exponent  $\gamma$  if it is sparse and the following stands:

$$\lim_{k \rightarrow \infty} \frac{\log p_k}{-\log k} = \gamma. \quad (1.4)$$

## Chapter 2

# Fractality and self-similarity of complex networks

Self-similar pattern of fractal structures, a concept introduced by Mandelbrot [44], is one of the most influential results of 20th century mathematics [20], [65]. The significance of fractal geometry is due to the fact that it turned to be a valuable tool that can properly describe numerous complex systems as diverse as coastlines [42], snowflakes [45] or even stock market movements [43].

The question naturally comes up: Does fractality and self-similarity characterize complex networks? We have already mentioned that according to empirical studies real-world networks share some fundamental common properties: small-world and scale-free character. Small-world property implies that the number of nodes increases exponentially with the diameter of the network; it appears to contradict a basic property of fractality (similarity over different length scales): fast increase of the diameter with the system size. Furthermore, scale invariance of fractal object also seems to be contrary to the scale-free property of networks, where the scale has naturally limited range. Along these lines, at first sight, it seems that small-world and scale-free properties contradict to fractality and these features cannot co-exist in the same network. On the other hand, in recent years Song, Havlin, Makse and Gallos have published a number of papers ([60], [59], [61], [22]) to unfold the

fractality of complex networks and they showed that several real-world networks are fractal networks (e.g. WWW, protein interaction network), other scholars such as Goh, Slavi, Kim and Kahng also presented some approaches to analyze networks that reveals the underlying self-similarity [25]. In the following sections we will follow them to reconcile the seemingly contradictory aspects and sometimes we will handle the lack of mathematical precision.

## 2.1 Box covering and fractality

The technique of identifying the presence of fractality in complex networks is analogous to that of regular fractals (see Figure 2.1). In the case of conventional fractal objects embedded in the Euclidean space, a basic tool is box-covering (or box box-counting) method [20], [11] and it also turns to be practical regarding networks [66]. Although the Euclidean metric is not relevant for networks, there is a more natural metric, namely the shortest (or geodesic) path length between two nodes (see Section 1.2).

The method works as follows [59]: For a given network  $G$ , we partition the vertices into boxes of size  $l_B$ . A box is a set of nodes where all distances  $d_{i,j}$  between any two nodes  $i$  and  $j$  within the box are smaller than  $l_B$  (it is illustrated in Figure 2.1). The minimum number of boxes needed to cover the entire network  $G$  is denoted by  $N_B(l_B)$ . As long as  $l_B = 1$ ,  $N_B(l_B)$  is clearly equal to the size of the network  $|N|$ , while provided that  $l_B > \text{Diam}(G)$ , then obviously  $N_B = 1$ . However, to identify the minimum number of boxes  $N_B(l_B)$  for any given  $l_B$  belongs to a family of NP-hard problems [59] and Section 2.2 is devoted to this question. (For the time being let's assume that we have an efficient algorithm that can find a nearly optimal box covering.)

In accordance with regular fractals, the fractal dimension or box dimension ( $d_B$ ) can be defined by:

$$N_B(l_B) \approx l_B^{-d_B}, \quad (2.1)$$

i.e. the required number of boxes scales as a power law with the box size. To determine the fractal dimension numerically, we plot the logarithm of  $N_B(l_B)$

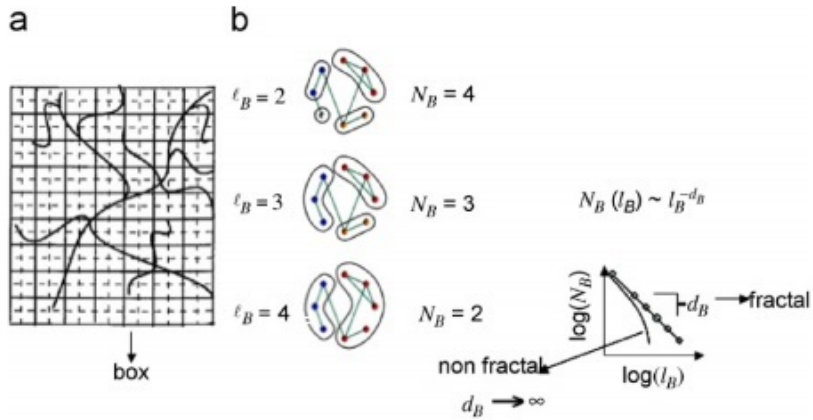

Figure 2.1: The box-covering algorithm as employed in (a) a regular fractal object, and (b) a complex network of eight nodes. The fractal dimension is determined by the scaling of the number of boxes  $N_B$  versus the size of the box  $l_B$ . The figure is from [22].

against the logarithm of  $l_B$ , if the relation between the two is linear (i.e. it implies power law scaling), then the network has a finite fractal dimension, that is the additive inverse of the slope of the best-fit line on our plot (see Figure 2.1).

Although it is possible to ascertain the fractal dimension with the above description, it is not mathematically precise and none of the papers give a rigorous mathematical definition. Considering regular fractal objects the box dimension (or Minkowski-dimension) is defined as the limit of the opposite of the ratio of the logarithm of the number of boxes and the logarithm of the box size, as the box size tends to 0. This definition would have no sense with respect to networks, since shortest path length can't be less than 1. On the other hand, tending to infinity might be a solution if the network itself grows. For this reason, we work with the concept of graph sequence  $\{G_n\}_{n \in \mathbb{N}}$  as we have introduced in Section 1.2. Now, we can define the box dimension of a graph sequence in the following way:

**Definition 2.1.** *The box dimension  $d_B$  of a graph sequence  $\{G_n\}_{n \in \mathbb{N}}$  is defined by*

$$d_B := \lim_{l_B \rightarrow \infty} \lim_{n \rightarrow \infty} \frac{\log N_B^n(l_B)}{-\log l_B}, \quad (2.2)$$

where  $N_B^n(l_B)$  denotes the minimum number of  $l_b$ -boxes needed to cover  $G_n$ .

Although the order of limits is quite natural in the previous definition, the question comes up whether the limiting operations can be interchanged. Considering the fact that the number of boxes needed to cover  $G_n$  is clearly  $N_B^n(l_B) = 1$  if  $l_B > \text{Diam}(G_n)$ , so it is meaningless to change the order of the limits. We note here that in the latter definitions formulated for graph sequences  $\{G_n\}_{n \in \mathbb{N}}$  we always take the limit in  $n$  first according to similar consideration.

The above definition is one approach of making the concept of box dimension mathematically more precise. On the other hand, this definition deals with graph limits and does not explain the box dimension of networks on finite vertices, however, network scientists are more interested in the latter. In most cases the box dimension is determined for real-world networks with the following strategy: one plots the number of  $l_B$ -boxes needed to cover the network against the box size  $l_B$  on log-log scale. As follows, we see a plot of  $\log l_B \mapsto \log N_B(l_B)$ . Therefore, if Eq. 2.1 is satisfied by the examined network, then  $\log N_B(l_B) \approx -d_B \log l_B$ , thus the slope is a straight line and the negative of the slope of the straight line is the box dimension (as we can see in Figure 2.2). Of course, to make this procedure more exact, one should follow a principled statistical framework [13], including the estimation of the lower (and upper) bound of the scaling region  $l_{B,\min} < l_B < l_{B,\max}$  (with marginal likelihood method), estimating the scaling parameter  $d_B$  (using method of maximum likelihood) and testing the hypothesis (i.e. calculating the goodness-of-fit between the data and the fitted model). This is a general framework of fitting power law distributions, a more detailed description can be found in [13]. In the remainder of this thesis, we mention several power-law scaling relations similar to 2.1, however, we will not repeat this procedure later but we call the reader's attention that this is the strategy behind power-law fitting, i.e any assertions similar to  $f(x) \approx x^{-\alpha}$ .

The power law form of Eq. 2.1 (with a finite  $d_B$ ) can be verified by plotting and fitting in a number of real-world networks such as WWW, actor collaboration network (illustrated in Figure 2.2) and protein interaction networks [61], however another family of complex networks (called non-fractal

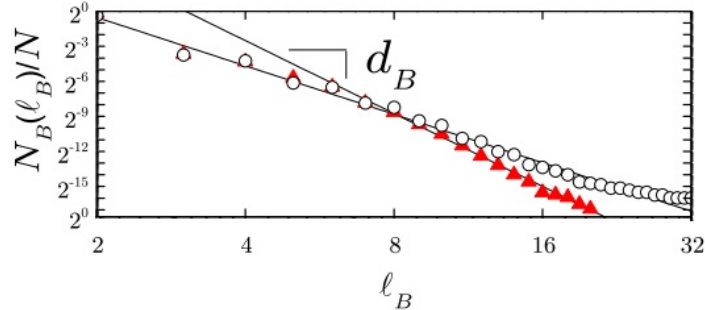

Figure 2.2: Measuring the box dimension  $d_B$  in real world networks via a log-log plot of  $N_B$  versus  $l_B$ . The white circles shows the measurements in case of the WWW, while red triangles refers to the co-appearance network of Hollywood actors. The figure is from [60].

networks) is characterized by a sharp decay of  $N_B$  with  $l_B$  (i.e. has infinite fractal dimension), such a network is Internet at router level [22]. This distinction makes necessary to introduce the concept of fractality [60]:

**Definition 2.2.** *The **fractality** of a network (also called fractal scaling or topological fractality) stands for the power-law relation between the minimum number of boxes needed to cover the entire network and the size of the boxes. Strictly speaking, a graph sequence is fractal if a finite box dimension  $d_B$  exists in the sense of 2.1.*

## 2.2 Box-covering algorithm

We have seen that covering the network with boxes has central importance in studying fractality of complex networks. In this section we investigate the optimal box-covering problem and survey some algorithms.

First, we state and prove that optimally covering a graph with boxes of given size and determining the minimum number of boxes needed to tile the graph belongs to the family of NP-hard problems [59]. In the following we assume the reader's acquaintance with standard concepts of computational complexity theory that may be found e.g. in [35] or in [57].

**The box-covering problem:** Given a  $G$  graph and an  $l_B \in \mathbb{N}, 2 \leq l_B \leq \text{Diam}(G)$  natural number. The box-covering of  $G$  with  $l_B$ -boxes is a partition of the vertices of  $G$  into boxes (subgraphs of  $G$ , i.e. sets of nodes and links between them) such that all the distances  $d_{i,j}$  between any two nodes  $i$  and  $j$  within the box are smaller than  $l_B$ ; in other words, the diameter of a box is at most  $l_B - 1$ . It can be stated either as an optimization problem or as a decision problem. In the decision problem version, the input is a pair  $(G, l_B)$  and an integer  $m$ ; the question is whether there is a box-covering of  $G$  with  $m$  or less  $l_B$ -boxes. In the box-covering optimization problem, the input is a pair  $(G, l_B)$ , and the task is to find a box-covering that uses the fewest boxes.

**Theorem 2.3.** *The decision version of box-covering is NP-complete, and the optimization version of box-cover is NP-hard.*

The following version of the proof is my own.

*Proof of Theorem 2.3.* In the proof we use polynomial time reduction, in particular we show that a certain NP-complete problem is no more difficult than the box-covering problem, because whenever an efficient algorithm exists for the box-covering problem, one exists for the first problem as well.

Let  $G^k$  denote a graph constructed from  $G$ , the vertex set of  $G^k$  is the same as in case of  $G$ , two vertices of  $G^k$  are joined with an edge if and only if in  $G$  they can be reached on a path of length at most  $k$  from each other. The construction of  $G^k$  from  $G$  can be achieved in polynomial time since a modified breadth-first search (BFS) finds the shortest paths between every pair of vertices in  $O(|V|^2 + |V||E|)$  [35].

It is easy to see that covering  $G$  with boxes of size  $l_B = i$  is transformed into covering  $G^{i-1}$  with boxes of size  $l_B = 2$ . On the other hand, covering a graph with boxes of size  $l_B=2$  (i.e. the box diameter is 1) is the same as the classical clique cover problem (also sometimes called partition into cliques), one of Richard Karp's original 21 problems shown NP-complete in his 1972 paper [29].

It remains to show that the decision problem is in NP. Finding an efficient witness is trivial (the partition itself) and it is also clear that the verifier executes in polynomial time. Now we can conclude that the decision problem



of box covering is NP-complete and it is well-known that if an optimization problem has an NP-complete decision version then it is NP-hard.  $\square$

In [59] Song et al. give an other argument for the fact that box-covering problem is NP-hard, namely they show that it can be mapped on to a vertex coloring problem. Here we sketch this reasoning: For a graph  $G$  we obtain an auxiliary graph  $G'$  by removing all edges in  $G$  and connecting nodes that are separated by a distance greater than or equal to  $l_B$  in  $G$ . The vertex coloring procedure is to color the nodes of  $G'$  using minimum possible number of colors in such a way that no edge connects two identically colored vertices. It is not hard to see that this scheme give rise to a natural box covering in the original graph  $G$ , in the sense that the nodes of the same color will necessarily form a box since they are separated by a distance less than  $l_B$  in  $G$ . Therefore, the minimum number of boxes to cover  $G$  is equal to the chromatic number of the auxiliary graph  $G'$ . The procedure is visualized in Figure 2.3.

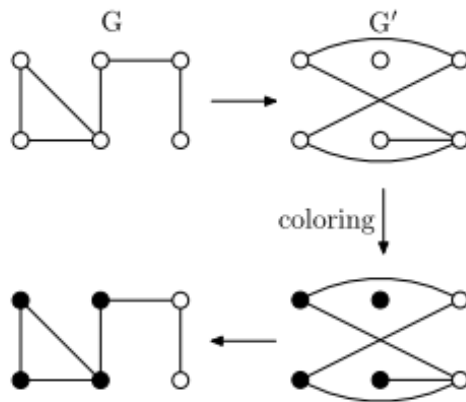

Figure 2.3: Illustration of the solution of the box-covering problem via mapping to the vertex coloring problem (here  $l_B = 3$ ). The figure is from [59].

Accordingly, no efficient algorithm exists that computes the optimal solution of box-covering for large networks, a brute-force approach can be found in [54]. However, in order to investigate the fractality of large networks, approximate algorithms should be considered. A widely adopted way is mapping

box-covering to graph coloring problem since vertex coloring is an extensively researched topic and several algorithms are present in literature [40], [31]. The most common - and a vast amount of analysis is based on that (e.g. [39], [26]) - is greedy coloring algorithm [59] due to its high efficiency and significant accuracy. The results of the greedy algorithm may depend on the ordering of vertices, various heuristic ordering strategies exist [28].

There are several other algorithms for box-covering [66], such as compact-box-burning (CBB) [59], maximum-excluded-mass-burning [59] or random-sequential-box-covering. Here we present the CBB algorithm, that belongs to the family of burning algorithms, a traditional geometrical approach based on breadth-first-search. The basic idea is creating a box by evolving it from one randomly chosen node until the box is compact, i.e. there do not exist any other vertices that could be included in the box. Compact-box-burning (CBB) works as follows [59]:

- (i) Construct the candidate set  $C$  of all yet uncovered vertices.
- (ii) Choose a random node  $u$  from the set  $C$  and delete it from  $C$ .
- (iii) Delete all vertices  $v$  from  $C$  whose distance from  $u$  is greater than or equal to  $l_B$  (i.e.  $d(u, v) \geq l_B$ ) since these vertices can not belong to the same box by definition.
- (iv) Repeat steps (ii) and (iii) until the candidate set is empty.
- (v) The set of the chosen nodes  $u$  forms a compact box. Repeat the procedure from (i) until the entire network is covered.

It is important to note that for some of the above algorithms (e.g. CBB) the connectivity of boxes is not guaranteed. In other words, for some boxes there may not exist a path within the box that connects two vertices residing in the same box or equivalently the boxes may overlap. However, according to the definition of box-covering, disconnectedness is not allowed. Song et al. found that all the presented algorithms yield approximately the same value for fractal dimension  $d_B$  [59].

## 2.3 Renormalization and self-similarity

After tiling the system with  $l_B$ -boxes, we can apply a renormalization procedure to it, that is an essential technique in modern statistical physics [12], [53]. The point of this approach is to create smaller replicas of a given object, preserving the main structural features and expecting the coarse-gained copies to be more tractable to analysis. The idea behind the renormalization of complex networks arises from the concept of self-similarity, that is whether the network looks roughly the same under different length-scales. In this section (following Song et al. [60]) the different scales will be based on renormalization principles and the invariance of the essential structural features will be expressed by the degree distribution.

The method works as follows [60]: After optimally covering the entire network with boxes of given size  $l_B$  (for details see Section 2.1), each box is replaced by a single node and two nodes are connected if and only if at least one link existed between the two corresponding boxes in the original network. Therefore we create a network where the small-scale structure have made indistinct and the length scale is now different. We can apply the same process to the renormalized network to obtain the second renormalization stage network, and continue until we are left with a single node, provided that the graph is connected (the procedure is illustrated in Figure 2.4).

Investigating several real-world scale-free networks (in the sense of Eq. 1.2) it turns out that in many cases the main properties, such as the degree distribution, remain invariant during the renormalization stages [51]. Thus, the new probability distribution also follows a power law with the same exponent  $\gamma$ :

$$P'(k) \approx k^{-\gamma}, \quad (2.3)$$

where  $P'(k)$  is the probability that a node chosen randomly in the renormalized graph has degree  $k$ .

The above property is clear in case of graph sequences since (for a given box-size  $l_B$ ) the renormalization stages of a graph sequence  $\{G_n\}_{n \in \mathbb{N}}$  are also well-defined graph sequences  $\{G'_n\}_{n \in \mathbb{N}}, \{G''_n\}_{n \in \mathbb{N}}, \dots, \{G_n^{(k)}\}_{n \in \mathbb{N}}, \dots$ . Therefore it is reasonable to require for these graph sequences to have degree distri-

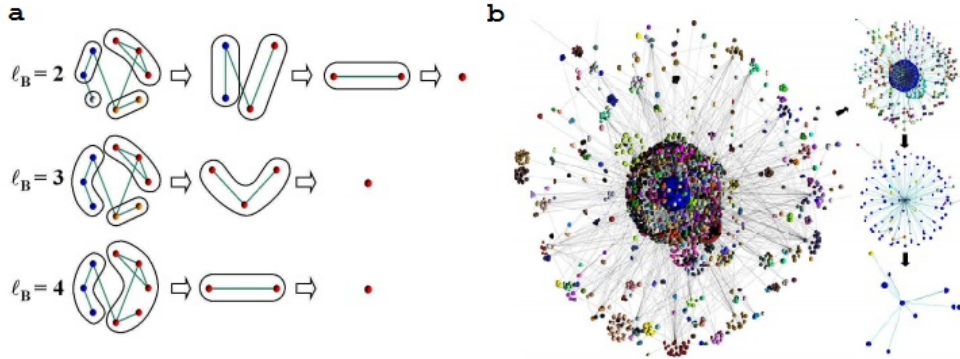

Figure 2.4: The renormalization procedure for complex networks. In (a) the method is demonstrated for different box sizes  $l_B$  in a network demo. In (b) the renormalization scheme is applied to the entire WWW (with  $l_B = 3$ ). The figure is from [60].

butions with the same scale-free degree exponent  $\gamma$  (in the sense of Definition 1.2). An example of such a graph sequence is the hierarchical graph sequence model [34], a generalized version of BRV model [4], that is invariant under renormalization with the natural choice of  $l_B = N$  (where  $N$  is the size of the base graph), a detailed investigation can be found in my BSc thesis [47].

Nevertheless, the concept of renormalization invariance of networks on finite vertices is ambiguous in the literature. The number of vertices is strictly decreasing during the renormalization procedure (until there is only one single node as it is illustrated in Figure 2.4), clearly it makes necessary to restrict our expectation of renormalization invariance to a certain number of steps (terminating condition can be the maximum renormalization steps to make or the minimum number of vertices in the renormalized network). Furthermore, it is still problematic how to define invariant degree distribution between two stages; considering the fact that the number of nodes is decreasing it is plausible to require the same power law scaling in different scaling regions, e.g. for degrees  $k_{\min} < k < k_{\max}$  in case of the unrenormalized network and for  $k'_{\min} < k' < k'_{\max}$  regarding the renormalized network; empirical results yield [60] that the scaling relation between the degrees of the unrenormalized and renormalized networks ( $k$  and  $k'$  respectively) can be characterized in a

certain sense by a linear scaling law as you can see in Eq. 2.4.

As we mentioned earlier, the property of renormalization-invariant degree distribution is shared by a lot of complex networks, this feature also applies in non-fractal networks such as the Internet [22]. It necessitates to introduce a new notion and distinguish between fractality and self-similarity (although traditional fractal theory does not separate the two concepts).

**Definition 2.4.** *The **self-similarity** of a network means that the degree distribution is invariant under renormalization, i.e. a network is self-similar if satisfies 2.3 for an appropriate renormalization procedure.*

We note here that if the probability distribution of a graph sequence is invariant under renormalization for  $l_B = l$  then it is also true for  $l_B = l^i$ ,  $\forall i \in \mathbb{N}$ , since boxing of  $G_n$  with box-size  $l_B = l^{i-1}$  corresponds to the boxing of  $G_n^{(i)}$  with box-size  $l_B = l$ , where  $G_n^{(i)}$  denotes the graph after  $i$  renormalization steps. A similar result is also true for finite networks taking into consideration that the range of feasible box sizes is limited.

The renormalization procedure can also help us to understand the evolution of many networks, in particular biological networks [22]. The inverse renormalization process can be considered as the time evolution of the network, that is the growth from a single node (e.g. a primitive protein) via duplication and divergence into a more complex network, illustrated in Figure 2.5.

Renormalization can also give rise to a new scaling relation observed in many real-world fractal networks. Song et al. noticed that plotting the degree  $k_B(l_B)$  of each vertex in the renormalized network versus the degree  $k_{\text{hub}}$  of the most connected node in the corresponding box exhibits a linear scaling law [60]:

$$k_B(l_B) \approx s(l_B) \cdot k_{\text{hub}}, \quad (2.4)$$

where  $s(l_B)$  is called the scaling factor. The above scaling relation can be understood by the same statistical framework that we have described in Section 2.1.

It is also an empirical finding that the scaling factor  $s$  ( $s < 1$ ) scales with

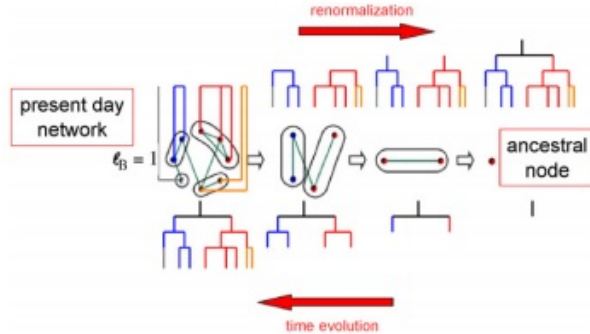

Figure 2.5: The inverse renormalization process can be seen as the evolution of a network from a single node diverging into a complex network. In the inverse process a node is replaced by a box that contains more vertices and a number of edges between them, such that the distance between any two nodes within a box is less than a given box size  $l_B$ . The figure is from [22].

$l_B$  defining a new exponent  $d_k$  (referred also as degree exponent):

$$s(l_B) \approx l_B^{-d_k}. \quad (2.5)$$

The degree exponent of a graph sequence can be defined in the same manner as Definition 2.1:

**Definition 2.5.** *The degree exponent  $d_k$  of a graph sequence  $\{G_n\}_{n \in \mathbb{N}}$  is defined by*

$$d_k := \lim_{l_B \rightarrow \infty} \lim_{n \rightarrow \infty} \frac{\log s^n(l_B)}{\log l_B}, \quad (2.6)$$

where  $s^n(l_B)$  denotes the scaling factor corresponding to  $G_n$  and box size  $l_B$ .

## 2.4 Network dimensions and their connection

It was found in [60] that the previously introduced measures such as fractal dimension  $d_B$ , degree exponent  $d_k$  and scale-free exponent  $\gamma$  are not all independent from each other. The following assertion was made in [60] supported by theoretical reasoning and numerical verification (i.e. measurements on real-world networks):

**Claim 2.6.** *If a complex graph is scale-free (its degree distribution follows a power law with exponent  $\gamma$ ), fractal (has finite box dimension  $d_B$ ), self-similar (its degree distribution is invariant under renormalization) and has finite degree exponent  $d_k$  then the following relation holds between the three indices:*

$$\gamma = 1 + \frac{d_B}{d_k}. \quad (2.7)$$

*Heuristic proof of Claim 2.6 and some comments on the proof.* Here we first describe an extended version of the argument from [60] repeated in many sources (e.g. [51], [58]). To start with, we collect the equations result from the assumptions of the claim:

$$\frac{N}{N_B(l_B)} \approx l_B^{d_B}, \quad (2.8)$$

$$P(k) \approx k^{-\gamma} \text{ and } P'(k') \approx k'^{-\gamma}, \quad (2.9)$$

$$k_B(l_B) \approx s(l_B) \cdot k_{\text{hub}}, \quad (2.10)$$

$$s(l_B) \approx l_B^{-d_k}. \quad (2.11)$$

In the equations above, 2.8 refers to fractality derived from 2.1 ( $N$  denotes the number of vertices,  $N_B(l_B)$  is the minimum number of  $l_B$ -boxes); in 2.9  $P(k)$  and  $P'(k')$  denote the degree distributions of the original and renormalized graph respectively, thus 2.9 means that the network is scale-free and self-similar; while equations 2.10 and 2.11 relate to the existence of finite degree exponent and they are the same as 2.4 and 2.5.

The number of vertices in the renormalized network is the same as the number of boxes needed to cover the unrenormalized network at any given  $l_B$ . According to [60] from equation 2.9 we obtain a density balance equation between the number of nodes with degree  $k$  in the original graph and the number of nodes with degree  $k'$  after the renormalization. (In the original proof the authors used  $=$  instead of  $\approx$ , while it would be more accurate to use  $\approx$ , but we keep their notation, since it does not cause misunderstanding.)

$$NP(k) dk = N_B(l_B)P'(k') dk'.$$

From this we get

$$NP(k) = N_B(l_B)P'(k') \frac{dk'}{dk}.$$

Let us choose  $k := k_{\text{hub}}$  and the corresponding vertices in the renormalized graph have degree  $k_B(l_B)$ , so using equation 2.10 we have

$$NP(k_{\text{hub}}) = N_B(l_B)P(s(l_B) \cdot k_{\text{hub}}) \cdot s(l_B).$$

Substituting equation 2.9 leads to

$$Nk_{\text{hub}}^{-\gamma} = N_B(l_B)k_{\text{hub}}^{-\gamma}s(l_B)^{-\gamma}s(l_B).$$

After simplification we have

$$\frac{N}{N_B(l_B)} = s(l_B)^{-\gamma+1}.$$

From equations 2.8 and 2.11 we obtain

$$l_B^{d_B} = \left(l_B^{-d_k}\right)^{-\gamma+1}.$$

Thus  $d_B = -d_k(-\gamma + 1)$  and it gives rise to desired result

$$\gamma = 1 + \frac{d_B}{d_k}.$$

We would like to raise concerns about the above proof, not only because of the lack of rigorous formulation of the concepts that the argument starts with (we have already mentioned these issues in the previous sections). It is also not clear how equation 2.9 implies the density balance equation  $NP(k) dk = N_B(l_B)P'(k') dk'$  or what this means exactly, what the mathematical meaning of such an equation is.

In [70] Parhami et al. also demonstrate that Claim 2.6 is inadequately justified in [60], they also doubt that invariance of degree distribution under renormalization holds in general. A new derivation is given in [70] to Claim 2.6 without using self-similarity (invariance under renormalization). However,



they begin the proof with setting

$$s(l_B) := \left( \frac{N}{N_B(l_B)} \right)^{\frac{1}{1-\gamma}} \quad (2.12)$$

leading to a tautological argument. It is obscure how we get 2.12 and what meaning it has (apart from the fact that it makes the claim easily derivable).

We also mention that if we replace our assumptions (equations 2.8 - 2.11) with the earlier introduced more rigorous concepts (formulated for graph sequences, such as Definitions 2.1 and 2.5) we cannot derive such a relation between the three indices.

□

## 2.5 Further network dimensions

The dimension of a system is one of the most essential metrics to characterize its structure and basic features. In the theory of complex networks the concept of dimension is heavily discussed and several distinct definitions have been introduced in the literature, the best definition may depend on the nature of the problem being studied. Besides the notions that we have already seen, now we mention the most important other definitions without attempting to be comprehensive. For example, metric dimension is defined as the minimum number of vertices in an  $S$  subset of the network such that all other vertices are uniquely determined by their distances to the vertices in  $S$  [27]. There are also definitions based on the scaling property of volume (or mass) with radius [55], a similar approach lead to the so called fractal cluster dimension [60], or based on the complex network zeta function [56]. For networks embedded in Euclidean space, one can define a dimension that describe the number of vertices that can be reached with an average Euclidean distance [16]. We have also introduced a new concept (the modified box dimension) in my BSc thesis [47] in order to investigate the fractality of the hierarchical graph sequence model [34].

The remainder of this chapter is devoted to cluster fractal dimension since

it is useful to the better understanding of the co-existence of the small-world and fractal properties. The cluster fractal dimension is defined with the help of cluster-growing method that works as follows [60]. We pick a seed node  $v$  at random and consider the  $l$ -neighborhood  $\Gamma_v^l$  (defined in Section 1.2), it can be also called as a cluster. Let  $M_v^l$  denote the number of nodes in the cluster  $\Gamma_v^l$ , i.e.  $M_v(l) = |\Gamma_v^l|$ . Then we repeat the procedure by choosing many seed nodes at random and consider the average “mass” of the resulting clusters, strictly speaking we write  $M(l) = \mathbb{E}_v(M_v(l))$  and the cluster dimension  $d_f$  is given by the following scaling:

$$M(l) \approx l^{d_f}. \quad (2.13)$$

Similarly to Definition 2.1 we can define the cluster dimension of a graph sequence in the following manner:

**Definition 2.7.** *The cluster dimension  $d_f$  of a graph sequence  $\{G_n\}_{n \in \mathbb{N}}$  is defined by*

$$d_f := \lim_{l \rightarrow \infty} \lim_{n \rightarrow \infty} \frac{\log M^n(l)}{\log l}, \quad (2.14)$$

where  $M^n(l)$  denotes the expected size of an  $l$ -neighborhood in  $G_n$ .

For a complex network with small-world property (see Section 1.2)  $d_f = \infty$  holds. Since small-worldness readily implies that for sufficiently big  $l$  and for an average  $v$  we have  $M_v(l) = |\Gamma_v^l| \approx e^l$ , i.e.  $M(l) \approx e^l$ . Hence

$$d_f \approx \frac{\log M(l)}{\log l} \approx \frac{l}{\log l} \rightarrow \infty \quad (2.15)$$

Therefore, if we try to measure the fractal dimension of a small-world network using the cluster growing method then it points out that these networks cannot be characterized by a finite dimension, even though the box dimension (see Definition 2.1) can be finite. The reason behind this discrepancy can be better clarified studying the average mass (number of vertices) of a box in case of a network characterized by a finite box dimension  $d_B$  [51]. For a given  $l_B$  and a given network with  $N$  vertices the average mass of a box  $\langle |B(l_B)| \rangle$

is

$$\langle |B(l_B)| \rangle = \frac{N}{N_B(l_B)} \approx l_B^{d_B}, \quad (2.16)$$

as opposed to the exponential scaling of the average mass of a cluster  $M(l) \approx e^l$ . This difference is due to the topology of real-world scale-free networks, expressly the presence of several highly connected hubs implying that most of the nodes can be reached from the hubs via few steps. Therefore, the hubs are overrepresented in the  $\Gamma_v^l$  clusters, there is a very high probability of including the same hubs in almost all clusters. On the other hand, box-covering method is a global tiling and once a hub (or any other vertex) is covered, it cannot be covered again. It is also important to note that this distinction between box and cluster dimensions does not emerge for a homogenous network characterized by a narrow degree distribution, but the cluster-growing and box-counting methods yield the same exponent, i.e.  $d_B = d_f$ , since in this case every node typically has the same number of neighbors [60].

## 2.6 Origins and influence of fractality

The standard models for generating scale free networks, such as the preferential attachment model [2] or the configuration model [6], [46] do not produce self-similar or fractal networks [61]. In this section we show two possible approaches to understand the origin of the fractal property in complex networks: the “repulsion between hubs” principle by Song et al. [61] and the study of the skeleton (spanning tree) of the graph by Kim et al. [25]. In addition, we also point out the importance and influence of fractality of real-world networks.

### 2.6.1 The “repulsion between hubs” principle

The main feature that seems to distinguish the fractal networks is an effective “repulsion” (dissortativity) between nodes with high degree (hubs), this idea was first suggested by Yook et al. based on empirical evidence [71] and

developed by Song et al. with analytical and modeling confirmations [61]. To put in other words, the most connected vertices tend to not be directly linked with each other but they prefer to link with less-connected nodes. In contrast, in case of non-fractal networks, hubs are primarily connected to hubs.

The degree correlation can be captured by studying the neighbor connectivity  $\langle k_{nn} \rangle$ , i.e. the average degree of neighbors of a node with degree  $k$  [49]. This term is formally defined as:

$$\langle k_{nn} \rangle = \sum_{k'} k' P(k'|k),$$

where  $P(k'|k)$  is the conditional probability that a vertex of degree  $k$  is connected to a vertex with degree  $k'$ . Another means of measuring the assortativity is the Pearson correlation coefficient of degree between pairs of linked vertices, also known as assortativity coefficient [48].

We have already seen a network evolution approach using the inverse renormalization procedure (illustrated in Figure 2.5), however this is not a real network growth model, since it only sketches a possible evolution knowing the future network. Now we present a simple network generation model motivated by the inverse renormalization process that can capture the main features of real-world fractal networks [61].

- **Initial condition:** We start at  $t = 0$  with a simple structure of a few vertices (e.g. a star shape of five nodes).
- **Growth:** At each time step  $t + 1$  we link  $m \cdot \text{deg}_t(v)$  new vertices to every  $v$  vertex that is already present in the network, where  $m$  is an input parameter and  $\text{deg}_t(v)$  is the degree of vertex  $v$  at time  $t$ .
- **Rewiring edges:** At each time step  $t + 1$  we rewire the already existing edges as a stochastic combination of Mode I (with probability  $e$ ) and Mode II (with probability  $1 - e$ )
  - **Mode I:** we keep the old edge generated before time  $t + 1$

- **Mode II:** we substitute the edge  $(u, v)$  generated in one of the previous time steps by a link between newly added nodes, i.e. by an edge  $(u', v')$ , where  $u'$  and  $v'$  are newly added neighbors of  $u$  and  $v$  respectively, as shown in Figure 2.6.

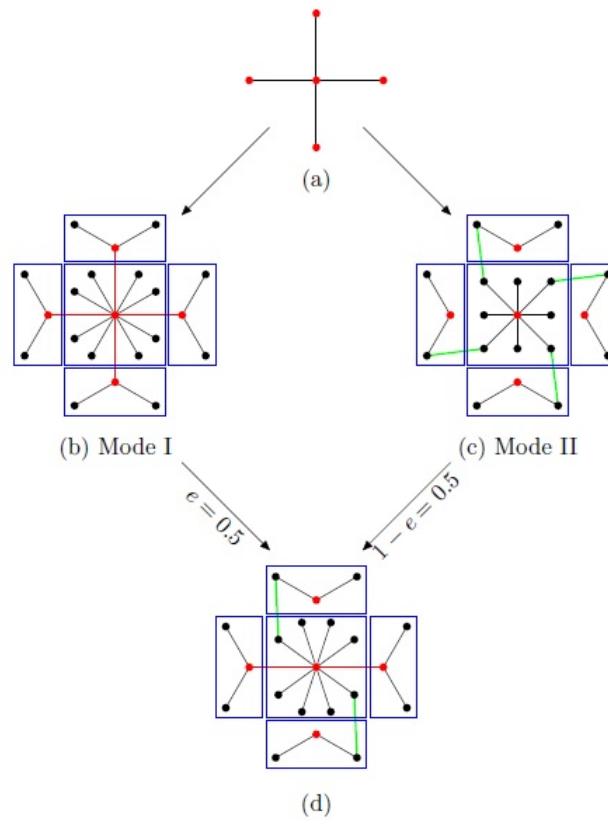

Figure 2.6: Different modes of growth with  $m = 2$ . In (a) the initial stage is illustrated, (b), (c) and (d) demonstrates Mode I, Mode II and the combination of the two modes respectively. The figure is from [61].

The model evolves by linking new nodes to already existing ones as follows: those nodes that appeared in the earlier stages form the hubs in the network. Consequently, Mode I leaves the direct edges between the hubs leading to hub-hub attraction, on the contrary Mode II leads to hub-hub repulsion or anticorrelation. It is interesting to investigate how the connection mode affects the fractality of the model, what happens if only one of the modes is

used ( $e = 0$  or  $e = 1$ ) or the stochastic combination of the two modes.

First, we establish some basic facts about the graph sequence model  $\{G_t\}_{t \in \mathbb{N}}$  in general. It is easy to see that the number of vertices in the network at time  $t$  is deterministic, namely:  $N(t) = N(t-1) + 2m \cdot E(t-1)$ , where  $E(t)$  denotes the number of edges in the network at time  $t$ . It is also obvious that we add the same number of vertices as edges in all steps, i.e.  $N(t+1) - N(t) = E(t+1) - E(t)$ . It is important to note that the paper [61] that introduced the model claims that  $N(t) = E(t)$ , but the validity of this equation depends on the initial configuration (and only holds if  $N(0) = E(0)$ ). Nevertheless, it is clear that the number of nodes increases exponentially with time, i.e.  $N(t) \approx e^t$ .

**Lemma 2.8.** *The above network generation model with parameter  $e = 1$  (i.e. using only Mode I) leads to a small-world non-fractal topology.*

The above assertion was claimed in [61] with heuristic explanation, here we give a more analytical argument.

*Proof of Lemma 2.8.* If we use only Mode I ( $e = 1$ ), the diameter increases by 2 in every step, thus  $\text{Diam}(G_{t+1}) = \text{Diam}(G_t) + 2$ . It implies that the diameter grows proportionally to the logarithm of the number of nodes in the network, i.e.  $\text{Diam}(G_t) \approx \log N(t)$  leading to a small-world network. In order to handle fractality we should examine the boxing of the graph sequence. It is easy to recognize that we can cover  $G_t$  with  $N(t-1)$  boxes of size  $l_B = \text{Diam}(G_0) + 1$  as it is also suggested by Figure 2.6. Another quite apparent observation (following from the hierarchical structure of the model) is that  $G_t$  can be covered with  $N(t-i-1)$  boxes of size  $l_B = \text{Diam}(G_i) + 1$  if  $t-i-1 \geq 0$  and clearly only one box is enough to cover  $G_t$  if  $t < i+1$ . Let  $N_B^t(d_i)$  denote the minimum number of boxes of size  $l_B = \text{Diam}(G_i) + 1$  needed to cover  $G_t$ , so we have

$$N_B^t(d_i) \leq \begin{cases} N(t-i-1) & \text{if } t \geq i+1 \\ 1 & \text{if } t < i+1. \end{cases} \quad (2.17)$$

It is less straightforward to verify that this is the optimal boxing (if

$\text{Diam}(G_0) \leq 2$ ) or at least asymptotically optimal (if  $\text{Diam}(G_0) > 2$ ). We can observe that in case of covering  $G_t$  with boxes of size  $l_B = \text{Diam}(G_i) + 1$  we can find  $N\left(t - i - \left\lceil \frac{\text{Diam}(G_0)}{2} \right\rceil\right)$  witness vertices such that the pairwise distances between the vertices are greater than  $\text{Diam}(G_i)$ . It means that

$$N_B^t(d_i) \geq \begin{cases} N\left(t - i - \left\lceil \frac{\text{Diam}(G_0)}{2} \right\rceil\right) & \text{if } t \geq i + \left\lceil \frac{\text{Diam}(G_0)}{2} \right\rceil \\ 1 & \text{if } t < i + \left\lceil \frac{\text{Diam}(G_0)}{2} \right\rceil. \end{cases} \quad (2.18)$$

(Here we do not give the exact construction but for the boxing of the hierarchical graph sequence model [34] a complete rigorous proof can be found in my BSc thesis [47] and the optimal boxing of this model can be proved in a very similar way.) Therefore putting together 2.17 and 2.18 we can conclude that  $N_B^t(d_i) \approx N(t - i)$ , this together with the exponential grow of  $N(t) \approx e^t$  (implying  $N_B^t(d_i) \approx e^{t-i}$ ) and the linear grow of  $\text{Diam}(G_t) = \text{Diam}(G_0) + 2t \approx t$  yields that no finite  $d_B$  exists in the sense of Definition 2.1, thus Mode I leads to a small-world non-fractal topology.  $\square$

Now we determine the degree distribution of the model if only Mode I is used (i.e.  $e = 1$ ).

**Lemma 2.9.** *The degree distribution of the network generation model with parameter  $e = 1$  (i.e. using only Mode I) is scale-free with  $\gamma = \frac{\log(2m+1)}{\log(m+1)}$ .*

The following argument is my own.

*Proof of Lemma 2.9.* First of all, we suppose that  $N(0) = E(0)$  and at  $t = 0$  all the vertices are of the same degree  $\text{deg}_0(v) = c \approx 1 \forall v \in V(G_0)$ , where  $\text{deg}_t(v)$  denotes the degree of vertex  $v$  at time  $t$ . It is obvious from the construction that  $\text{deg}_{t+1}(v) = \text{deg}_t(v) \cdot (m + 1)$ . It implies that  $G(t)$  has only vertices of degree  $k = (m + 1)^i$   $i = 0, 1, \dots, t$ . Let  $V_t(i)$  denote the number of vertices of degree  $(m + 1)^i$  in  $G(t)$ , then we have

$$V_t(i) = \begin{cases} N(t - i - 1) \cdot 2m & \text{if } 0 \leq i \leq t - 1 \\ N(0) & \text{if } i = t. \end{cases} \quad (2.19)$$

Let us check whether the total number of vertices of the possible degrees equals the number of nodes in  $G(t)$ :

$$\begin{aligned}
\sum_{i=0}^t V_t(i) &= N(0) + \sum_{i=1}^t N(i-1) \cdot 2m = N(0) + \sum_{i=1}^t (2m+1)^{i-1} \cdot N(0) \cdot 2m \\
&= N(0) + 2mN(0) \sum_{j=0}^t (2m+1)^j = N(0) + 2m \cdot N(0) \frac{(2m+1)^t - 1}{2m} \\
&= N(0) \cdot (2m+1)^t = N(t).
\end{aligned}$$

The degree distribution now can be calculated, the probability that a uniformly chosen vertex from  $G(t)$  has degree  $(m+1)^i$  is obviously  $P_t((m+1)^i) = V_t(i)/N(t)$ , thus we obtain:

$$\begin{aligned}
P_t(k) &= P_t((m+1)^i) = \frac{V_t(i)}{N(t)} = \frac{2m \cdot N(t-i-1)}{N(t)} \\
&= \frac{2m \cdot (2m+1)^{t-i-1} \cdot N(0)}{(2m+1)^t \cdot N(0)} = 2m \cdot (2m+1)^{-i-1}
\end{aligned}$$

We search for a scale-free degree exponent  $\gamma(t)$  such that  $P_t(k) \approx k^{-\gamma(t)}$ , i.e.  $((m+1)^i)^{-\gamma(t)} \approx 2m \cdot (2m+1)^{-i-1}$ . Taking the logarithm we get:

$$\begin{aligned}
-\gamma(t)i \log(m+1) &\approx \log(2m) + (-i-1) \log(2m+1) \\
\gamma(t) &\approx \frac{\log(2m)}{-i \log(m+1)} + \frac{(-i-1) \log(2m+1)}{-i \log(m+1)}.
\end{aligned}$$

Using that  $\frac{\log(2m)}{-i \log(m+1)} \approx 0$  and  $\frac{i+1}{i} \approx 1$  if  $i$  is sufficiently big we obtain:

$$\gamma = \gamma(t) = \frac{\log(2m+1)}{\log(m+1)}. \quad (2.20)$$

Therefore we can conclude that the model is scale-free with a finite  $\gamma$  exponent. We note here that this result for  $\gamma$  does not agree with the formula that can be found in [61], since in that paper the author claims that the scale-free exponent of this model is  $\gamma = 1 + \frac{\log(2m+1)}{\log(m+1)}$ .

□



If we rewire all the edges according to Mode II ( $e = 0$ ), the diameter increases multiplicatively  $\text{Diam}(G_{t+1}) = 3 \cdot \text{Diam}(G_t) + 2$ , since in each step we replace the edges by three-long paths and the  $+ 2$  term comes by adding new vertices, this leads to an exponential growth in the diameter with time  $\text{Diam}(G_t) = (\text{Diam}(G_0) + 1) \cdot 3^{t-1} - 1 \approx 3^t = e^{t \log 3}$  and consequently to the absence of the small-world property. Using similar argument as in the proof of Lemma 2.8 we obtain that the model has fractal property with a finite box dimension  $d_B = \frac{\log(2m+1)}{\log 3}$  [61].

In the general case (for an intermediate  $0 < e < 1$ ) the diameter grows as  $\text{Diam}(G_{t+1}) \approx (3 - 2e)\text{Diam}(G_t) + 2e$  and the model reproduces both small-world property and finite fractal exponents  $d_B$  and  $d_k$  [61], the visualization of this stochastic small-world fractal network model can be seen in Figure 2.7.

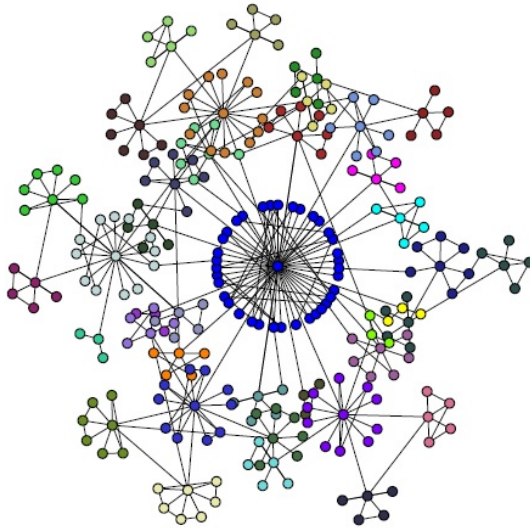

Figure 2.7: Resulting topology predicted by the stochastic combination of Mode I and Mode II with  $e = 0.8$ . The different colors represent the boxing of the network. The figure is from [61].

## 2.6.2 Skeleton of complex networks

Another way to understand the origin of fractality is to examine the so called skeletons of complex networks proposed by Kim et al. [30],[25]. The method is motivated by a similar intention as renormalization (as presented in Section 2.3): to simplify the complexity but preserving the main structural features. In what follows, this more simple structure is the spanning tree. The spanning tree of a graph on  $n$  vertices is a subset of  $n - 1$  edges that form a tree. We will consider a particular spanning tree - called skeleton - that can be regarded as the “communication kernel” of the network, in the sense that it handles most of the traffic or information flow. To put in mathematically precise terms, skeleton refers to the spanning tree that maximizes the edge betweenness centrality.

**Definition 2.10.** *The betweenness centrality (sometimes also referred to as load)  $b_e$  of an edge (or node)  $e$  is defined as*

$$b_e = \sum_{i,j \in V, i \neq j} \frac{c_{i,j}(e)}{c_{i,j}}, \quad (2.21)$$

where  $c_{i,j}$  denotes the number of shortest paths connecting  $i$  and  $j$ , while  $c_{i,j}(e)$  is the number of shortest paths connecting  $i$  and  $j$  passing through  $e$ .

Edges (or nodes) with high betweenness centrality (BC) has a large influence on the transfer of items (e.g. information) through the network, under the probable assumption that item transfer follows the shortest paths [24]. An important discovery is that the distribution of the edge betweenness centrality is very inhomogeneous in scale-free networks, indicating the existence of edges with extremely high BC, thus used for communication very frequently; this assertion makes it more interesting to investigate the spanning tree that maximizes the sum of edge BC, namely the skeleton [30].

A group of the department’s fellows (including me) has provided social network analysis in the scope of a university project in partnership with a leading telecommunication company and betweenness centrality also played an important role in our analysis, a lot more details about this case study can be found in the caption of Figure 2.8.

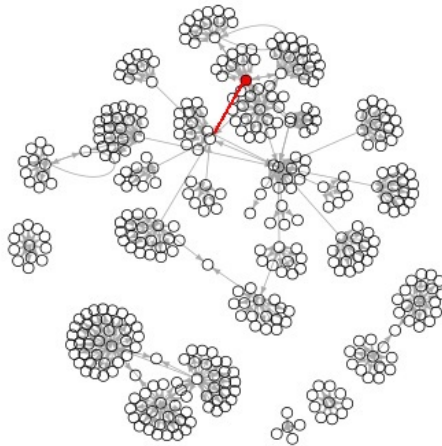

Figure 2.8: Case study: We have provided social network analysis to a large telecommunication company. The figure shows a telephone call network based on real sample data, namely MIT Reality Mining Dataset [18]. The network illustrates the call connections between 411 MIT students during the 11th week of 2005. It was part of our job to explore the key users (and connections) with respect to their role in the social network. There are several ideas to measure the centrality, one of them is betweenness centrality, it is roughly speaking proportional to the number of geodesics (shortest paths) going through a vertex, see Definition 2.10. If a user (represented by a vertex) has large betweenness it means that his/her opinion may be quite important in the community. The edge with maximal betweenness centrality can be considered as the “backbone” (since it is the most important edge in the skeleton). The vertex and edge with maximal betweenness are colored by red.

After determining the betweenness centrality of each edge, we assign the BC as the weight of each edges then we negate the weights of all edges. The construction of the skeleton is equivalent to find the minimum spanning tree of the previously defined weighted network, therefore all the classical methods can be used: Prim’s, Kruskal’s or Borůvka’s algorithm [5]. The residual edges (the ones not included in the skeleton) can be regarded as the shortcuts (since they shorten paths on the spanning tree). It was pointed out in [30] based on empirical observations that the skeleton of a scale-free network is also scale-free but with different  $\gamma$  exponent.

The investigation of the skeleton of fractal networks shed light on the ori-

gin of fractality. After performing fractal scaling analysis on the underlying skeleton of several real-world networks, it came into view that for the fractal networks, the numbers of boxes needed to cover the original networks and its skeleton are almost the same. Even though these networks are far from being a tree, the shortcuts are distributed in such a way that the fractality is preserved. The reason of this is that the shortcuts connect nodes mostly within modules (or branches) and the connections between different modules are provided by the skeleton. This topological structure can be measured by the “length” of a shortcut between vertices  $i$  and  $j$ , in the sense of the minimum number of steps from  $i$  to  $j$  on the spanning tree, for fractal networks the “length” of the shortcuts are typically small (for illustration see Figure 2.9). Based on these observations a model of fractal networks was introduced in [25].

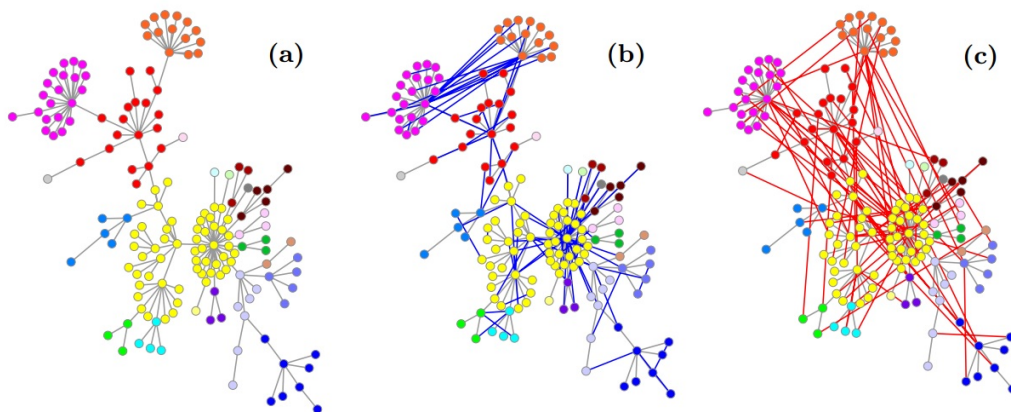

Figure 2.9: We consider the scale-free tree illustrated in (a). In (b) and (c) shortcuts are added, in (b) the shortcuts are “short” resulting a fractal network, while in (c) a non-fractal network is shown created by adding “long” shortcuts. The figure is from [25].

### 2.6.3 Influence and importance of fractality

We have seen different approaches to unravel the key principles that give rise to the fractal structure of complex networks. However, the question is still open: Why do real-world networks evolve into fractal networks, what impact

does fractality have on complex networks? Here we mention three important properties of fractal networks that have received considerable attention.

One of the most important property is robustness against random failure or intentional attacks. A network is regarded to be vulnerable to random errors / targeted attacks if removing a small number of random / certain vertices the graph falls apart. The most frequently used quantities to describe robustness are measuring the effect of removing nodes to the average size of the connected components  $\langle s \rangle$  or to the relative size of the largest component (the fraction of nodes that belong to the largest component). It was found by simulations and confirmed by calculations that scale-free networks show intense robustness against random node removal [1]. On the other hand, a number of scale free networks (such as Internet at router level) are extremely vulnerable to targeted attacks on the hubs [1]. However, the authors in [61] showed that fractal property of networks significantly increases the robustness to targeted attacks (in comparison with a a scale-free network of the same number of nodes, with same  $\gamma$  degree exponent, but different degree correlation) . Thus fractality makes scale-free networks less vulnerable and provides better protection when the hubs are removed from the system, since the hubs are more dispersed. This can serve as an explanation why most biological networks have evolved towards fractal topology.

Another feature that is closely related to fractality is transport (also referred to as diffusion or flow) on networks. The authors in [23] developed a scaling theory on transport and showed that fractality of networks tend to accelerate the diffusion process. Mathematically the diffusion problem is expressed through first passage problem (FPP or first hitting time) [38]. The most natural quantities to consider are the minimal weight of a path between two vertices  $x$  and  $y$  and the number of edges, often regarded as the hopcount, on this path. Clearly, without edge weights (and in this thesis we mainly consider unweighted networks) these quantities coincide. Another important related question is to determine the flooding time of the graph from a fixed vertex  $x$  i.e. the maximum of the shortest paths between  $x$  and all other vertices [33].

Finally, fractality seems to be heavily associated with modularity. As hubs

are isolated, one can consider the groups of nodes around a local hub being different functional modules (and this is really the case for some biological networks, e.g. protein interaction networks) [22]. One way to define modularity is through the renormalization procedure, boxes at a given length scale  $l_B$  are identified as the network modules for this scale [21].

**Definition 2.11.** *The modularity function  $M(l_B)$  of a network is given as follows*

$$M(l_B) := \frac{1}{N_B(l_B)} \sum_{i=1}^{N_B(l_B)} \frac{L_i^{in}}{L_i^{out}},$$

where the sum is over all boxes,  $L_i^{in}$  denotes the edges within the  $i$ th box and  $L_i^{out}$  is the edges that go out from the  $i$ th box.

We can notice that we have counted every edge between the boxes twice, since an edge that connects box  $i$  and box  $j$  appears both in  $L_i^{out}$  and  $L_j^{out}$ , so it may be reasonable to multiply by a factor 2.

We can gather even more information on the network structure if we examine how this property is modified under varying scales of observation, i.e. for different values of  $l_B$ . In [21] it was found that the dependence of  $M$  on  $l_B$  follows a power law in real-world fractal networks defining the modularity exponent  $d_M$

$$M(l_B) \approx l_B^{d_M}. \quad (2.22)$$

The exponent  $d_M$  demonstrates how modularity scales with length and discriminate modular (usually if  $d_M > 1$ ) from non-modular ( $d_M < 1$ ) networks. Experimental studies shows that real-world fractal networks are indeed modular (i.e.  $d_M > 1$ ) [21], in Section 3.1 we also calculate  $d_M$  for a mathematical fractal network model.

# Chapter 3

## Fractal network models

We have already remarked that in spite of the presence of fractality in several real-world networks, the common models of scale-free networks fail to exhibit fractal scaling. We have also presented and examined a fractal network model in the previous chapter (illustrated in Figure 2.7), in this chapter we demonstrate and investigate further deterministic and random fractal network models. Modeling real world fractal networks (i.e. producing an artificial object that is similar to the real one) is of great interest due to two main reasons: they provide insight into the origins that give rise to fractal property and mathematically tractable models allow for rigorous analysis.

### 3.1 Song-Havlin-Makse-model

This model is motivated by “repulsion between hubs” principle present in fractal networks (for more details see Subsection 2.6.1) and it shows that the correlations between degrees of vertices are a determinant factor for the fractality [51]. The generating algorithm works with a similar recursive approach as the network generation model that we have introduced in Subsection 2.6.1. The model starts with two vertices connected by an edge in generation  $n = 0$  [51]. Then the next generation is obtained recursively by adding  $m \cdot \deg_n(w)$  new vertices to every  $w$  vertices that is already present in the network, where  $\deg_n(w)$  is the degree of vertex  $w$  at generation  $n$ . To put in other words,

that is connecting  $m$  new vertices to the endpoints of each edge  $(u, v)$  of generation  $n$ . Furthermore, edge  $(u, v)$  is removed with probability  $e$  and replaced by  $x$  new  $((u^{(i)}, v^{(i)}))_{i=1, \dots, x}$  edges, where  $u^{(i)}$  and  $v^{(i)}$  are newly added neighbors of  $u$  and  $v$  respectively (see Figure 3.1). On the other hand, this description does not explain how to proceed if  $x > m$  and it is also not clear whether it is possible to choose a vertex more times or it is required that  $u^{(i)} \neq u^{(j)}$  and  $v^{(i)} \neq v^{(j)}$  if  $i \neq j$ .

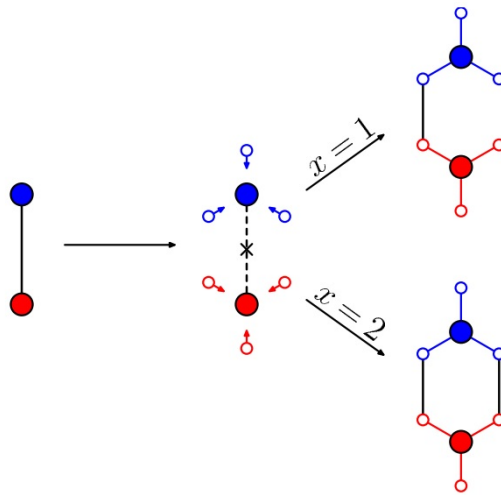

Figure 3.1: Illustration of the growth process in Song-Havlin-Makse-model. In this case, the original edge is removed and  $m = 3$  new vertices are attached to the endpoints with  $x = 1$  or  $x = 2$  new links between the new nodes. The figure is from [51].

A very similar model is investigated in details in terms of diameter, degree distribution and box dimension in Subsection 2.6.1, pointing out that the choice of  $e$  determines whether the network is small-world, fractal or both. Now we will follow [51] to examine another topological property of this model, namely the modularity (see Definition 2.11).

**Lemma 3.1.** *The modularity exponent of the Song-Havlin-Makse model is*  

$$d_M = \frac{\ln \frac{(2m+x-1)}{x}}{\ln 3}.$$

The following argument is my own motivated by the explanation from [51].



*Proof of Lemma 3.1.* In this model a module can be identified as the neighborhood of a central hub. More specifically, we will examine the model for  $e = 1$  (old edges are surely rewired) and in this case the  $l_B$ -modules of  $G(n)$  of size  $l_B = 3^i$ ,  $i < t$  can be recognized as the offspring (or neighborhood) of “old” vertices from  $G(n - i)$ . It is easy to see that if  $x = 1$  then the graph is a tree, while  $x > 1$  means that the different modules are connected by more edges. The number of edges within a module of size  $l_B = 3^i$  is approximately  $(2m + x - 1)^i$ , since each edge give rise to  $2m$  new links in a generation step and  $x - 1$  extra links are added, so using the notation of 2.11,  $L^{\text{in}} \approx (2m + x - 1)^i$ . The number of edges going out from a module of size  $l_B = 3^i$  is obviously  $L^{\text{out}} \approx x^i$ . Putting together these results, we obtain that the modularity function of the Song-Havlin-Makse model for  $e = 1$  is

$$M(l_B) = \frac{1}{N_B(l_B)} \sum_{j=1}^{N_B(l_B)} \frac{L_j^{\text{in}}}{L_j^{\text{out}}} = \frac{(2m + x - 1)^i}{x^i}, \quad (3.1)$$

where  $l_B = 3^i$ ,  $i \in \mathbb{N}$ .

The modularity exponent  $d_M$  of the network model is given by 2.22:

$$\frac{(2m + x - 1)^i}{x^i} \approx (3^i)^{d_M}, \quad (3.2)$$

which finally yields that for  $e = 1$  this network model has finite modularity exponent:

$$d_M = \frac{\ln \frac{(2m+x-1)}{x}}{\ln 3}. \quad (3.3)$$

□

A network is considered modular if  $d_M > 1$ , so now we can conclude that this model for  $e = 1$  is modular if  $\frac{2m+x-1}{x} > 3$ , i.e.  $m - \frac{1}{2} > x$ , which is the same as  $m > x$ , since both parameters are integer.

### 3.2 $(u,v)$ -flowers and -trees

In this section we present a new family of recursive scale-free networks, the  $(u, v)$ -flowers, proposed by Rozenfeld, Havlin and ben-Avraham [52]. This network model generalizes the hierarchical scale-free network model of Dorogostev, Golstsev and Mendes (DGM) [17] and appropriately modifying the parameters  $u$  and  $v$  results to either fractal or non-fractal networks [52] [50].

The algorithm to construct the  $(u, v)$ -flowers is as follows: In generation  $n = 1$  we start with a cycle graph consisting of  $u + v \equiv w$  nodes. Then, generation  $n + 1$  is achieved recursively by replacing each edge by two parallel paths of length  $u$  and  $v$ . In what follows we assume that  $u \leq v$ , without loss of generality. Examples of  $(1, 3)$ - and  $(2, 2)$ -flowers are illustrated in Figure 3.2. The DGM network corresponds to the special case of  $u = 1$  and  $v = 2$ .

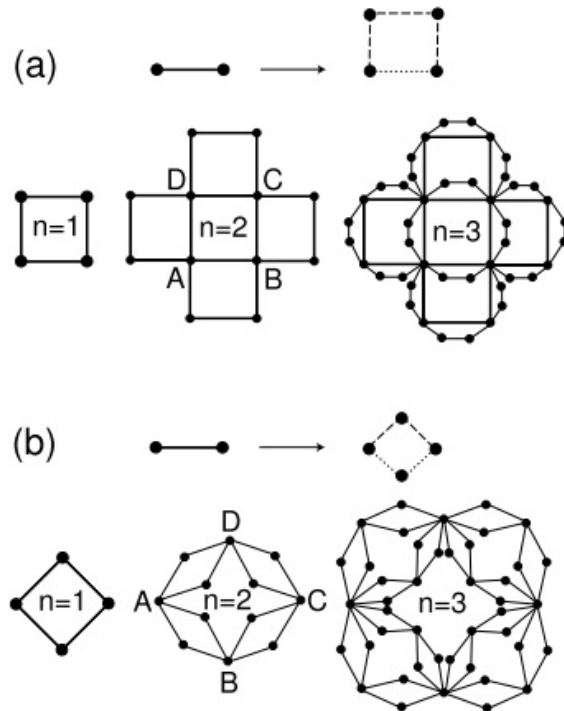

Figure 3.2: The first three iterations of  $(u, v)$ -flowers,  $u + v = 4$ . In (a)  $u = 1$ ,  $v = 3$ , while in (b)  $u = 2$ ,  $v = 2$ . The figure is from [52].

One of the most important properties of the  $(u, v)$ -flowers that they are self-similar, it follows easily from an equivalent method of construction: to obtain generation  $n + 1$ , create  $w = u + v$  copies of the network at step  $n$  and join them (glue them together) at the hubs (the exact connection rule is determined by  $u$  and  $v$ ) [52].

It is obvious from the second method of construction that the number of edges of a  $(u, v)$ -flower of generation  $n$  is

$$E_n = (u + v)^n = w^n. \quad (3.4)$$

While the number of vertices obeys the recursion relation [52]

$$V_n = wV_{n-1} - w,$$

that together with initial condition  $N_1 = w$  yields

$$V_n = w^n - \frac{w^n - w}{w - 1} = \left(\frac{w - 2}{w - 1}\right)w^n + \left(\frac{w}{w - 1}\right). \quad (3.5)$$

**Lemma 3.2.** *The degree distribution of  $(u, v)$ -flowers follows a power-law distribution with degree exponent  $\gamma = \frac{\ln(u+v)}{\ln 2}$ .*

First we note that it is claimed without proof in [52] and [17], also repeated in [51] that the degree exponent of the model is

$$\gamma = 1 + \frac{\ln(u + v)}{\ln 2}. \quad (3.6)$$

On the other hand, further investigation yields otherwise.

*Proof of Lemma 3.2.* It is easy to see from construction that  $(u, v)$ -flowers have only vertices of degree  $k = 2^m$ ,  $m = 1, 2, \dots, n$ . Let  $V_n(m)$  denote the number of vertices of degree  $2^m$  in the  $n$ th iteration of the graph, then we can obtain the following recursion formula:

$$V_n(m) = N_{n-1}(m - 1) + (w - 2)w^{n-1}\delta_{m,1},$$

where  $\delta_{m,1}$  stands for the Kronecker delta, i.e. it is 1 if  $m = 1$  and 0 otherwise. This leads to:

$$V_n(m) = \begin{cases} (w-2)w^{n-m}, & \text{if } m < n, \\ w, & \text{if } m = n. \end{cases} \quad (3.7)$$

First, if a vertex is chosen uniformly at random from the  $(u, v)$ -flower of generation  $n$ , then the probability that this vertex is of degree  $2^m$  is clearly  $P_n(2^m) = V_n(m)/V_n$ . That means that we search for  $\gamma(n)$  that satisfies the following formula (for  $k \geq k_0$ ):

$$P_n(k) \approx k^{-\gamma(n)}. \quad (3.8)$$

It is known that  $k$  is of the form  $2^m$  and we suppose that  $m < n$ , then we obtain:

$$P_n(k) = P_n(2^m) = \frac{V_n(m)}{V_n} = \frac{(w-2)w^{n-m}}{\frac{w-2}{w-1}w^n + \frac{w}{w-1}} = \frac{(w-2)w^{-m}}{\frac{w-2}{w-1} + \frac{w}{w-1}w^{-n}} \quad (3.9)$$

From the last form of 3.9 it can be seen that  $\frac{w}{w-1}w^{-n} \approx 0$  if  $n$  is sufficiently big. We search for  $\gamma(n)$  that satisfies  $P_n(2^m) \approx (2^m)^{-\gamma(n)}$ , so taking the logarithm base 2 of 3.9 we get:

$$\log_2(w-2) - m \log_2(w) - (\log_2(w-2) - \log_2(w-1)) \approx -m\gamma(n), \quad (3.10)$$

then using that  $\frac{\log_2(w-1)}{m} \approx 0$  if  $m$  is sufficiently big, we can write:

$$\log_2(w) \approx \gamma(n). \quad (3.11)$$

Thus we obtain that:

$$\gamma = \log_2(w) = \frac{\ln(w)}{\ln 2} = \frac{\ln(u+v)}{\ln 2}, \quad (3.12)$$

which does not agree with the formula of 3.6.  $\square$

Recursive scale-free trees constructed in a similar way as the flower networks [52]. However, it is not specified by the authors, it is a natural choice

to start with a path graph on  $u + v = w$  edges (other trees are also possible to start with). Generation  $n + 1$  of a  $(u, v)$ -tree is obtained by replacing every edge in generation  $n$  with a path of length  $\lfloor \frac{v}{2} \rfloor$ . The trees may be also built up by successively joining  $w$  copies at the appropriate hubs [52]. An example of  $(1, 2)$ -tree is shown in Figure 3.3.

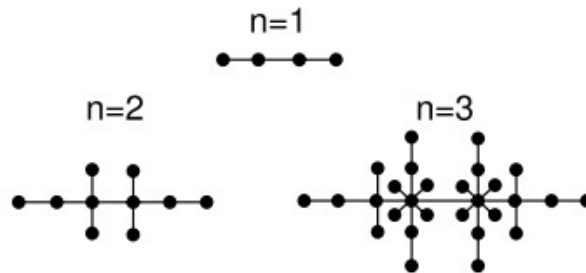

Figure 3.3: The first three iterations of  $(1, 2)$ -tree. The figure is from [52].

In the remainder of this section we will show that  $(u, v)$ -networks have different topological properties if  $u = 1$  or  $u > 1$  [52]. First, we consider the diameter of  $(u, v)$ -flowers, let  $D_n$  denote the diameter of the  $n$ -th iteration. If  $u = 1$ , it means that the distance between “old” vertices remains the same, so the diameter grows linearly (due to new vertices), namely:  $D_{n+1} = D_n + \lfloor \frac{v-1}{2} \rfloor + \lceil \frac{v-1}{2} \rceil = D_n + v - 1$ . Using the fact that we start with a cycle of  $1 + v$  vertices  $D_1 = \lfloor \frac{v+1}{2} \rfloor$ , which yields that:

$$D_n = \begin{cases} (v - 1)n + \frac{3-v}{2}, & \text{if } u = 1 \text{ and } v \text{ is odd,} \\ (v - 1)n + \frac{2-v}{2}, & \text{if } u = 1 \text{ and } v \text{ is even.} \end{cases}$$

Now we compute the diameter of the  $(u, v)$  flower if  $u > 1$ . It is clear the distance between “old” vertices grows by a factor of  $u$  (since each edge is replaced by parallel paths of  $u$  and  $v$ ,  $u \leq v$ ), adding new vertices to the graph also increases the diameter, expressly:  $D_{n+1} = D_n \cdot u + \lfloor \frac{v-u}{2} \rfloor + \lceil \frac{v-u}{2} \rceil = D_n \cdot u + v - u$ . Solving the recursion with the initial condition  $D_1 = \lfloor \frac{v+u}{2} \rfloor$

we conclude that:

$$D_n = u^{n-1} \left( \left\lfloor \frac{u+v}{2} \right\rfloor + \frac{v-u}{u-1} \right) + \frac{u-v}{u-1}, \quad \text{if } u > 1.$$

To summarize, the diameter of  $(u, v)$ -flowers scales as follows:

$$D_n \approx \begin{cases} (v-1)n, & \text{if } u = 1, \\ u^n, & \text{if } u > 1. \end{cases} \quad (3.13)$$

Similar reasoning yields that the diameter of  $(u, v)$ -trees  $D_n^{\text{tree}}$  is:

$$D_n^{\text{tree}} \approx \begin{cases} vn, & \text{if } u = 1, \\ u^n, & \text{if } u > 1. \end{cases} \quad (3.14)$$

Combining 3.13 with the fact that the number of nodes grows as a power of  $n$ ,  $V_n \approx (u+v)^n$  (see 3.5) implies that

$$D_n \approx \begin{cases} \ln V_n, & \text{if } u = 1, \\ V_n^{\frac{\ln u}{\ln(u+v)}}, & \text{if } u > 1. \end{cases} \quad (3.15)$$

Therefore,  $(u, v)$ -flowers are small-world only if  $u = 1$ .

In order to determine the box dimension  $d_B$  we use a heuristic argument from [51]. The change of the average mass of a box  $\langle |B(l_B)| \rangle$  upon the rescaling of the box-size by a factor  $c$  is clearly:

$$\langle |B(c \cdot l_B)| \rangle \approx c^{d_B} \langle |B(l_B)| \rangle. \quad (3.16)$$

Regarding  $(u, v)$ -flowers for  $u > 1$  we have:

$$\langle |B(u \cdot l_B)| \rangle \approx (u+v) \langle |B(l_B)| \rangle, \quad (3.17)$$

that yields that the box dimension of the  $(u, v)$ -flower (for  $u > 1$ ) is given by

$$d_B = \frac{\ln(u+v)}{\ln u}, \quad (3.18)$$

and no finite box dimension exists if  $u = 1$ . On the other hand, deriving 3.17 with mathematical precision is far from trivial.

# Chapter 4

## Summary

The purpose of this thesis was to explore and understand the theory of fractal networks with mathematical precision. We did not only conduct a comprehensive literature review but also handled the deficiency of mathematical rigor of related papers and proposed different approaches to make concepts more precise.

After giving a general introduction to network science and going through the most important notions of the topic, we gained an extensive understanding of fractality of complex networks. We presented the most important methods adopted from fractal theory and statistical physics to unfold the fractal and self-similar structure of real-world networks, namely box-covering and renormalization. Next, we investigated box-covering problem in detail and gave an own proof for the fact that it is NP-hard. We demonstrated some notions of fractal dimension and shed light on the connections between them. Furthermore, we uncovered the origin of fractality of networks with the help of different mathematical principles, then we reviewed the importance and influence of fractal networks.

Finally, we presented stochastic and deterministic fractal network models: Song-Havlin-Makse model along with  $(u, v)$ -flowers and -trees. We also examined specific aspects of these models, including the calculation of the diameter, degree distribution, modularity exponent and box dimension.

There are several possible future directions for the further study of frac-



tality of complex networks, especially regarding the mathematical aspects of the field. We have pointed out a number of dubious concepts (e.g. the necessity to distinguish between fractality and other notions in terms of static networks and evaluational networks or graph processes), we have also shown some assertions that are difficult to derive with mathematical rigor. On the other hand, laying the foundations of the mathematical theory of fractal networks remains to be completed.

Real-world networks are known to exhibit spatial heterogeneity, to treat this it is useful to investigate their multifractal properties. Accordingly, a promising research topic is to study the multifractal analysis of complex networks [15], [66].

There are also several relevant open questions in this topic from an empirical research perspective, such as investigating the stability of fractality or understanding why both fractal and non-fractal networks are present in nature. A bulk number of open questions can be found in [51] from a physicist's point of view.

# Bibliography

- [1] Réka Albert, Hawoong Jeong, and Albert-László Barabási. Error and attack tolerance of complex networks. *Nature*, 406(6794):378–382, 2000.
- [2] Albert-László Barabási and Réka Albert. Emergence of scaling in random networks. *Science*, 286(5439):509–512, 1999.
- [3] Albert-László Barabási and Jennifer Frangos. *Linked: the new science of networks*. Basic Books, 2014.
- [4] Albert-László Barabási, Erzsébet Ravasz, and Tamas Vicsek. Deterministic scale-free networks. *Physica A: Statistical Mechanics and its Applications*, 299(3):559–564, 2001.
- [5] Cüneyt F Bazlamaççı and Khalil S Hindi. Minimum-weight spanning tree algorithms a survey and empirical study. *Computers & Operations Research*, 28(8):767–785, 2001.
- [6] Béla Bollobás. A probabilistic proof of an asymptotic formula for the number of labelled regular graphs. *European Journal of Combinatorics*, 1(4):311–316, 1980.
- [7] Béla Bollobás and Oliver Riordan. The diameter of a scale-free random graph. *Combinatorica*, 24(1):5–34, 2004.
- [8] Béla Bollobás and Oliver M Riordan. Mathematical results on scale-free random graphs. *Handbook of graphs and networks: from the genome to the internet*, pages 1–34, 2003.

- [9] Christian Borgs, Jennifer Chayes, László Lovász, Vera T Sós, Balázs Szegedy, and Katalin Vesztergombi. Graph limits and parameter testing. In *Proceedings of the thirty-eighth annual ACM symposium on Theory of computing*, pages 261–270. ACM, 2006.
- [10] Stefan Bornholdt and Heinz Georg Schuster. *Handbook of Graphs & Networks*. Wiley Online Library, 2002.
- [11] Armin Bunde and Shlomo Havlin. *Fractals in science*. Springer-Verlag New York, Inc., 1995.
- [12] John Cardy. *Scaling and renormalization in statistical physics*, volume 5. Cambridge University Press, 1996.
- [13] Aaron Clauset, Cosma Rohilla Shalizi, and Mark EJ Newman. Power-law distributions in empirical data. *SIAM review*, 51(4):661–703, 2009.
- [14] National Research Council Committee on Network Science for Future Army Applications. *Network Science*. The National Academies Press, 2005.
- [15] Wang Dan-Ling, Yu Zu-Guo, and Vo Anh. Multifractal analysis of complex networks. *Chinese Physics B*, 21(8):080504, 2012.
- [16] Li Daqing, Kosmas Kosmidis, Armin Bunde, and Shlomo Havlin. Dimension of spatially embedded networks. *Nature Physics*, 7(6):481–484, 2011.
- [17] Sergey N Dorogovtsev, AV Goltsev, and José Ferreira F Mendes. Pseudofractal scale-free web. *Physical Review E*, 65(6):066122, 2002.
- [18] Nathan Eagle and Alex Pentland. Reality mining: sensing complex social systems. *Personal and ubiquitous computing*, 10(4):255–268, 2006.
- [19] Paul Erdős and A Rényi. On the evolution of random graphs. *Publ. Math. Inst. Hungar. Acad. Sci.*, 5:17–61, 1960.

- [20] Kenneth Falconer. *Fractal geometry: mathematical foundations and applications*. John Wiley & Sons, 2004.
- [21] Lazaros K Gallos, Chaoming Song, Shlomo Havlin, and Hernán A Makse. Scaling theory of transport in complex biological networks. *Proceedings of the National Academy of Sciences*, 104(19):7746–7751, 2007.
- [22] Lazaros K Gallos, Chaoming Song, and Hernán A Makse. A review of fractality and self-similarity in complex networks. *Physica A: Statistical Mechanics and its Applications*, 386(2):686–691, 2007.
- [23] Lazaros K Gallos, Chaoming Song, and Hernán A Makse. Scaling of degree correlations and its influence on diffusion in scale-free networks. *Physical review letters*, 100(24):248701, 2008.
- [24] Michelle Girvan and Mark EJ Newman. Community structure in social and biological networks. *Proceedings of the National Academy of Sciences*, 99(12):7821–7826, 2002.
- [25] K-I Goh, Giovanni Salvi, Byungnam Kahng, and Doochul Kim. Skeleton and fractal scaling in complex networks. *Physical review letters*, 96(1):018701, 2006.
- [26] Vishesh Gupta, Cayman Simpson, and Bharad Raghavan. An investigation of network fractality. 2014.
- [27] Frank Harary and RA Melter. On the metric dimension of a graph. *Ars Combin*, 2(191-195):1, 1976.
- [28] William Hasenplaugh, Tim Kaler, Tao B Schardl, and Charles E Leiserson. Ordering heuristics for parallel graph coloring. In *Proceedings of the 26th ACM symposium on Parallelism in algorithms and architectures*, pages 166–177. ACM, 2014.
- [29] Richard M Karp. *Reducibility among combinatorial problems*. Springer, 1972.

- [30] Dong-Hee Kim, Jae Dong Noh, and Hawoong Jeong. Scale-free trees: The skeletons of complex networks. *Physical Review E*, 70(4):046126, 2004.
- [31] Walter Klotz. Graph coloring algorithms. *Mathematics Report*, 5(2002):1–9, 2002.
- [32] Ljupco Kocarev and Visarath In. Network science: A new paradigm shift. *IEEE Network: The Magazine of Global Internetworking*, 24(6):6–9, 2010.
- [33] István Kolossváry and Júlia Komjáthy. First passage percolation on inhomogeneous random graphs. *arXiv preprint arXiv:1201.3137*, 2012.
- [34] Júlia Komjáthy and Károly Simon. Generating hierarchial scale-free graphs from fractals. *Chaos, Solitons & Fractals*, 44(8):651–666, 2011.
- [35] Jan Leeuwen. *Handbook of theoretical computer science: algorithms and complexity*, volume 1. Elsevier, 1990.
- [36] Lun Li, David Alderson, John C Doyle, and Walter Willinger. Towards a theory of scale-free graphs: Definition, properties, and implications. *Internet Mathematics*, 2(4):431–523, 2005.
- [37] Gipsi Lima-Mendez and Jacques van Helden. The powerful law of the power law and other myths in network biology. *Molecular BioSystems*, 5(12):1482–1493, 2009.
- [38] Yuan Lin, Alafate Julaiti, and Zhongzhi Zhang. Mean first-passage time for random walks in general graphs with a deep trap. *The Journal of chemical physics*, 137(12):124104, 2012.
- [39] Mario Locci, Giulio Concas, and Ivana Turnu. Computing the fractal dimension of software networks. In *Proceedings of the 9th WSEAS international conference on Applied computer science*, pages 146–151. World Scientific and Engineering Academy and Society (WSEAS), 2009.

- [40] László Lovász. Three short proofs in graph theory. *Journal of Combinatorial Theory, Series B*, 19(3):269–271, 1975.
- [41] László Lovász. *Large networks and graph limits*, volume 60. American Mathematical Soc., 2012.
- [42] Benoit B Mandelbrot. How long is the coast of britain. *Science*, 156(3775):636–638, 1967.
- [43] Benoit B Mandelbrot. How fractals can explain what’s wrong with wall street. *The Scientific American*, 2008.
- [44] Benoit B Mandelbrot, Dann E Passoja, and Alvin J Paullay. Fractal character of fracture surfaces of metals. 1984.
- [45] Yves Meyer and Sylvie Roques. Progress in wavelet analysis and applications. 1993.
- [46] Michael Molloy and Bruce Reed. A critical point for random graphs with a given degree sequence. *Random structures & algorithms*, 6(2-3):161–180, 1995.
- [47] Roland Molontay. Networks and fractals. Bsc thesis, Department of Stochastics, Budapest University of Technology and Economics, 2013.
- [48] Mark EJ Newman. Assortative mixing in networks. *Physical review letters*, 89(20):208701, 2002.
- [49] Romualdo Pastor-Satorras, Alexei Vázquez, and Alessandro Vespignani. Dynamical and correlation properties of the internet. *Physical Review Letters*, 87(25):258701, 2001.
- [50] Hernán D Rozenfeld and Daniel Ben-Avraham. Percolation in hierarchical scale-free nets. *Physical Review E*, 75(6):061102, 2007.
- [51] Hernán D Rozenfeld, Lazaros K Gallos, Chaoming Song, and Hernán A Makse. Fractal and transfractal scale-free networks. In *Encyclopedia of Complexity and Systems Science*, pages 3924–3943. Springer, 2009.

- [52] Hernán D Rozenfeld, Shlomo Havlin, and Daniel Ben-Avraham. Fractal and transfractal recursive scale-free nets. *New Journal of Physics*, 9(6):175, 2007.
- [53] Manfred Salmhofer. *Renormalization*. Springer Science & Business Media, 1999.
- [54] Christian M Schneider, Tobias A Kesselring, José S Andrade Jr, and Hans J Herrmann. Box-covering algorithm for fractal dimension of complex networks. *Physical Review E*, 86(1):016707, 2012.
- [55] O Shanker. Defining dimension of a complex network. *Modern Physics Letters B*, 21(06):321–326, 2007.
- [56] O Shanker. Graph zeta function and dimension of complex network. *Modern Physics Letters B*, 21(11):639–644, 2007.
- [57] Michael Sipser. *Introduction to the Theory of Computation*. Cengage Learning, 2012.
- [58] Chaoming Song. *Self-similarity and scaling theory of complex networks*. ProQuest, 2008.
- [59] Chaoming Song, Lazaros K Gallos, Shlomo Havlin, and Hernán A Makse. How to calculate the fractal dimension of a complex network: the box covering algorithm. *Journal of Statistical Mechanics: Theory and Experiment*, 2007(03):P03006, 2007.
- [60] Chaoming Song, Shlomo Havlin, and Hernan A Makse. Self-similarity of complex networks. *Nature*, 433(7024):392–395, 2005.
- [61] Chaoming Song, Shlomo Havlin, and Hernán A Makse. Origins of fractality in the growth of complex networks. *Nature Physics*, 2(4):275–281, 2006.
- [62] Michael PH Stumpf and Mason A Porter. Critical truths about power laws. *Science*, 335(6069):665–666, 2012.

- [63] Reiko Tanaka. Scale-rich metabolic networks. *Physical review letters*, 94(16):168101, 2005.
- [64] Remco Van Der Hofstad. Random graphs and complex networks. Available on <http://www.win.tue.nl/rhofstad/NotesRGCN.pdf>, 2009.
- [65] Tamás Vicsek. *Fractal growth phenomena*, volume 2. World Scientific, 1992.
- [66] Danling Wang. *Multifractal characterisation and analysis of complex networks*. PhD thesis, Queensland University of Technology, 2011.
- [67] Duncan J Watts. Six degrees, 2003.
- [68] Duncan J Watts and Steven H Strogatz. Collective dynamics of small-world networks. *Nature*, 393(6684):440–442, 1998.
- [69] Walter Willinger, David Alderson, and John C Doyle. *Mathematics and the internet: A source of enormous confusion and great potential*. Defense Technical Information Center, 2009.
- [70] Wenjun Xiao, Limin Peng, and Behrooz Parhami. On general laws of complex networks. In *Complex Sciences*, pages 118–124. Springer, 2009.
- [71] Soon-Hyung Yook, Filippo Radicchi, and Hildegard Meyer-Ortmanns. Self-similar scale-free networks and disassortativity. *Physical Review E*, 72(4):045105, 2005.