

MATH32051/42051/62051

Hyperbolic Geometry

Charles Walkden

4th September, 2017

Contents

0	Preliminaries	3
1	Where we are going	6
2	Length and distance in hyperbolic geometry	13
3	Circles and lines, Möbius transformations	18
4	Möbius transformations and geodesics in \mathbb{H}	22
5	More on the geodesics in \mathbb{H}	25
6	The Poincaré disc model	37
7	The Gauss-Bonnet Theorem	42
8	Hyperbolic triangles	50
9	Fixed points of Möbius transformations	54
10	Classifying Möbius transformations: conjugacy, trace, and applications to parabolic transformations	58
11	Classifying Möbius transformations: hyperbolic and elliptic transformations	61
12	Fuchsian groups	64
13	Fundamental domains	69
14	Dirichlet polygons: the construction	73
15	Dirichlet polygons: examples	77
16	Side-pairing transformations	82
17	Elliptic cycles	85
18	Generators and relations	90
19	Poincaré's Theorem: the case of no boundary vertices	95
20	Poincaré's Theorem: the case of boundary vertices	100

21	The signature of a Fuchsian group	107
22	Existence of a Fuchsian group with a given signature	115
23	Properly discontinuous group actions	121
24	Limit sets of Fuchsian groups	130
25	Some algebraic properties of Fuchsian groups	140
26	Classifying elementary Fuchsian groups	144
27	Non-elementary Fuchsian groups	147
28	Where we could go next	154
29	All of the exercises	157
30	Solutions	172

0. Preliminaries

§0.1 Contact details

The lecturer is Dr Charles Walkden, Room 2.241, Tel: 0161 275 5805,
Email: charles.walkden@manchester.ac.uk.

My office hour is: Monday 12pm–1pm. If you want to see me at another time then please email me first to arrange a mutually convenient time.

§0.2 Course structure

§0.2.1 MATH32051

MATH32051 is a 10 credit course. There will be about 22 lectures and a weekly examples class. The examples classes will start in Week 2.

For the 10-credit course, we will cover the material in Chapters 1–22 (although we will only sketch the details that are in Chapter 22), and Chapter 28.

For Chapters 1–22, the material in each chapter corresponds to one lecture.

§0.2.2 MATH42051, MATH62051

MATH42051/62051 are 15 credit courses. The course will consist of the taught lectures, together with independent reading material on limit sets. There will be fortnightly support classes for the reading material, starting in week 3 (see the timetable for details).

For the 15-credit course, we will cover the material in Chapters 1–22 (sketching the details that are in Chapter 22) and 28 in the lectures, and discuss the material in Chapters 23–27 in the fortnightly support classes.

§0.2.3 Lecture notes

This file contains a complete set of lecture notes. The lecture notes contain more material than I present in the lectures. This allows me to expand on minor points for the interested student, present alternative explanations, etc. Only the material I cover in the lectures is examinable.

The lecture notes are available on the course webpage. The course webpage is available via Blackboard or directly at www.maths.manchester.ac.uk/~cwalkden/complex-analysis. Please let me know of any mistakes or typos that you find in the notes.

I will use the visualiser for the majority of the lectures. I will upload scanned copies of what I write on the visualiser onto the course webpage. I will normally upload these onto the course webpage within 3 working days of the lectures.

§0.2.4 Exercises

The lectures also contain the exercises. For your convenience I've collated all the exercises into a single section at the end of the notes; here, I've indicated which exercises are particularly important and which are there for completeness only. The exercises are a key part of the course.

§0.2.5 Solutions to the exercises

This file contains the solutions to all of the exercises. I will trust you to have a serious attempt at the exercises before you refer to the solutions.

§0.2.6 Support classes

The support classes are a key part of the course. I will try to make them as interactive as possible by getting you to revise material that will be useful in the course or getting you to work through some of the exercises, perhaps with additional hints. Towards the end of the course we will spend time doing past exam papers. You should consider attendance at the examples classes to be compulsory.

The handouts in the support classes comprise of questions from the exercises and past exams. These handouts do not contain any material that is not already available within these notes or within the past exam papers on the course webpage; as such I will not be putting these handouts on the course webpage.

§0.2.7 Lecture capture

The lectures will be recorded using the University's lecture capture system. However, Lecture Capture only records the audio and the output of the data projector. The overwhelming majority of the lectures will be given on the blackboard. Hence relying on lecture capture will not be an adequate substitute for attending the lectures.

§0.3 Coursework and the exam

The coursework for this year will be a 40 minute closed-book test taking place during Week 6 (reading week). All questions on the test are compulsory and it will be in the format of an exam question. Thus, looking at past exam papers will provide excellent preparation for the test. You will need to know the material from sections 1–1 in the lecture notes for the test (this is the material that we will cover in weeks 1–5).

Your coursework script, with feedback, will be returned to you within 15 working days of the test. You will be able to collect your script from the Teaching & Learning Office reception on the ground floor of the Alan Turing Building.

The course is examined by a 2 hour (for MATH32051) or 3 hour (for MATH42051, MATH62051) written examination in January. The exam is in the same format as previous years: Section A contains four questions worth a total of 40 marks, Section B contains three questions, each worth 30 marks, of which you must do two. For MATH42051/62051, there is also an additional Section C with two questions worth a total of 50 marks.

§0.4 Recommended texts

J. Anderson, *Hyperbolic Geometry*, 1st ed., Springer Undergraduate Mathematics Series, Springer-Verlag, Berlin, New York, 1999.

S. Katok, *Fuchsian Groups*, Chicago Lecture Notes in Mathematics, Chicago University Press, 1992.

A. Beardon, *The Geometry of Discrete Groups*, Springer-Verlag, Berlin, New York, 1983.

The book by Anderson is the most suitable for the first half of the course. Katok's book is probably the best source for the second half of the course and for those of you doing 15-credit version. Beardon's book contains everything in the course, and much more. You probably do not need to buy any book and can rely solely on the lecture notes.

1. Where we are going

§1.1 Introduction

One purpose of this course is to provide an introduction to some aspects of hyperbolic geometry. Hyperbolic geometry is one of the richest areas of mathematics, with connections not only to geometry but to dynamical systems, chaos theory, number theory, relativity, and many other areas of mathematics and physics. Unfortunately, it would be impossible to discuss all of these aspects of hyperbolic geometry within the confines of a single lecture course. Instead, we will develop hyperbolic geometry in a way that emphasises the similarities and (more interestingly!) the many differences with Euclidean geometry (that is, the ‘real-world’ geometry that we are all familiar with).

§1.2 Euclidean geometry

Euclidean geometry is the study of geometry in the Euclidean plane \mathbb{R}^2 , or more generally in n -dimensional Euclidean space \mathbb{R}^n . This is the geometry that we are familiar with from the real world. For example, in a right-angled triangle the square of the hypotenuse is equal to the sum of the squares of the other two sides; this is Pythagoras’ Theorem.

But what makes Euclidean geometry ‘Euclidean’? And what is ‘geometry’ anyway? One convenient meta-definition is due to Felix Klein (1849-1929) in his Erlangen programme (1872), which we paraphrase here: given a set with some structure and a group of transformations that preserve that structure, *geometry* is the study of objects that are invariant under these transformations. For 2-dimensional Euclidean geometry, the set is the plane \mathbb{R}^2 equipped with the Euclidean distance function (the normal way of defining the distance between two points) together with a group of transformations (such as rotations, translations) that preserve the distance between points.

We will define hyperbolic geometry in a similar way: we take a set, define a notion of distance on it, and study the transformations which preserve this distance.

§1.3 Distance in the Euclidean plane

Consider the Euclidean plane \mathbb{R}^2 . Take two points $x, y \in \mathbb{R}^2$. What do we mean by the distance between x and y ? If $x = (x_1, x_2)$ and $y = (y_1, y_2)$ then one way of calculating the distance between x and y is by using Pythagoras’ Theorem:

$$\text{distance}(x, y) = \|x - y\| = \sqrt{(y_1 - x_1)^2 + (y_2 - x_2)^2}; \quad (1.3.1)$$

this is the length of the straight line drawn in Figure 1.3.1. Writing $d(x, y)$ for $\text{distance}(x, y)$ we can see that there are some natural properties satisfied by this formula for distance:

- (i) $d(x, y) \geq 0$ for all x, y with equality if and only if $x = y$,
- (ii) $d(x, y) = d(y, x)$ for all x, y ,

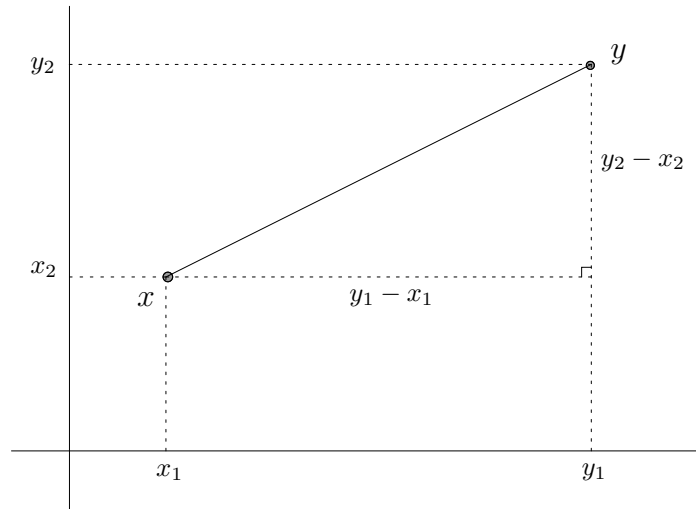

Figure 1.3.1: The (Euclidean) distance from x to y is the length of the ‘straight’ line joining them

$$(iii) \quad d(x, z) \leq d(x, y) + d(y, z) \text{ for all } x, y, z.$$

Thus, condition (i) says that the distance between any pair of distinct points is positive, condition (ii) says that the distance from x to y is the same as the distance from y to x , and condition (iii) says that that distance between two points is increased if we go via a third point. This is often called the *triangle inequality* and is illustrated in Figure 1.3.2.

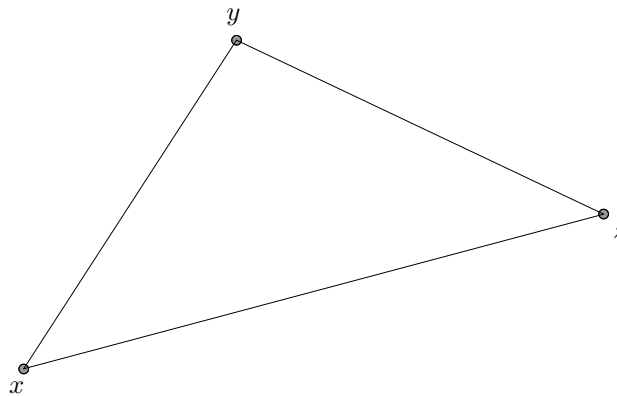

Figure 1.3.2: The triangle inequality: $d(x, z) \leq d(x, y) + d(y, z)$

In mathematics, it is often fruitful to pick out useful properties of known objects and abstract them. If we have a set X and a function $d : X \times X \rightarrow \mathbb{R}$ that behaves in the way that we expect distance to behave (that is, d satisfies conditions (i), (ii) and (iii) above), then we call X a *metric space* and we call d a *distance function* or a *metric*.

Because of our familiarity with Euclidean geometry, there are often issues surrounding our definitions that we do not realise need to be proved. For example, we define the distance between $x, y \in \mathbb{R}^2$ by (1.3.1) and recognise that the straight line drawn from x to y in Figure 1.3.1 represents the shortest ‘path’ from x to y : any other path drawn from x to

y would have a longer length. However, this needs proof. Note also that we have said that this straight line is ‘the’ shortest path; there are two statements here, firstly that there *is* a path of shortest length between x and y , and secondly that there is only *one* such path. These statements again need to be proved.

Consider the surface of the Earth, thought of as the surface of a sphere. See Figure 1.3.3. The paths of shortest length are arcs of great circles. Between most pairs of points, there is a unique path of shortest length; in Figure 1.3.3 there is a unique path of shortest length from A to B . However, between pairs of antipodal points (such as the ‘north pole’ N and ‘south pole’ S) there are infinitely many paths of shortest length. Moreover, none of these paths of shortest length are ‘straight’ lines in \mathbb{R}^3 . This indicates that we need a more careful approach to defining distance and paths of shortest length.

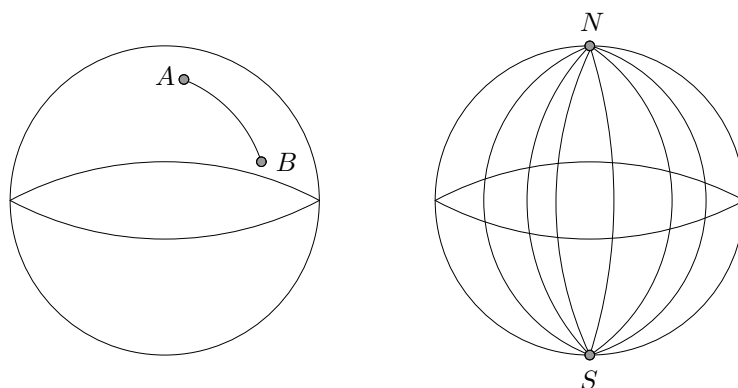

Figure 1.3.3: There is just one path of shortest length from A to B , but infinitely many from N to S

The way that we shall regard distance as being defined is as follows. Because *a priori* we do not know what form the paths of shortest length will take, we need to work with *all* paths and be able to calculate their length. We do this by means of path integrals. Having done this, we now wish to define the distance $d(x, y)$ between two points x, y . We do this defining $d(x, y)$ to be the minimum of the lengths of all paths from x to y .

In hyperbolic geometry, we begin by defining the hyperbolic length of a path. The hyperbolic distance between two points is then defined to be the minimum of the hyperbolic lengths of all paths between those two points. We then prove that this is indeed a metric, and go on to prove that given any pair of points there is a unique path of shortest length between them. We shall see that in hyperbolic geometry, these paths of shortest length are very different to the straight lines that form the paths of shortest length in Euclidean geometry. In order to avoid saying ‘straight line’ we instead call a path of shortest length a *geodesic*.

§1.4 Groups and isometries of the Euclidean plane

§1.4.1 Groups

Recall that a *group* G is a set of elements together with a group structure: that is, there is a group operation such that any two elements of G can be ‘combined’ to give another element of G (subject to the ‘group axioms’). If $g, h \in G$ then we denote their ‘combination’ (or ‘product’, if you prefer) by gh . The group axioms are:

- (i) associativity: if $g, h, k \in G$ then $(gh)k = g(hk)$;
 - (ii) existence of an identity: there exists an identity element $e \in G$ such that $ge = eg = g$ for all $g \in G$;
 - (iii) existence of inverses: for each $g \in G$ there exists $g^{-1} \in G$ such that $gg^{-1} = g^{-1}g = e$.
- A subgroup $H \subset G$ is a subset of G that is in itself a group.

§1.4.2 Isometries

An isometry is a map that preserves distances. There are some obvious maps that preserve distances in \mathbb{R}^2 using the Euclidean distance function. For example:

- (i) the identity map $e(x, y) = (x, y)$ (trivially, this preserves distances);
- (ii) a translation $\tau_{(a_1, a_2)}(x, y) = (x + a_1, y + a_2)$ is an isometry;
- (iii) a rotation of the plane is an isometry;
- (iv) a reflection (for example, reflection in the y -axis, $(x, y) \mapsto (-x, y)$) is an isometry.

One can show that the set of all isometries of \mathbb{R}^2 form a group, and we denote this group by $\text{Isom}(\mathbb{R}^2)$. We shall only be interested in *orientation-preserving isometries* (we will not define orientation-preserving here, but convince yourself that the first three examples above preserve orientation, but a reflection does not). We denote the set of orientation preserving isometries of \mathbb{R}^2 by $\text{Isom}^+(\mathbb{R}^2)$. Note that $\text{Isom}^+(\mathbb{R}^2)$ is a subgroup of $\text{Isom}(\mathbb{R}^2)$.

Exercise 1.1

Let R_θ denote the 2×2 matrix that rotates \mathbb{R}^2 clockwise about the origin through angle $\theta \in [0, 2\pi)$. Thus R_θ has matrix

$$\begin{pmatrix} \cos \theta & \sin \theta \\ -\sin \theta & \cos \theta \end{pmatrix}.$$

Let $a = (a_1, a_2) \in \mathbb{R}^2$. Define the transformation

$$T_{\theta, a} : \mathbb{R}^2 \rightarrow \mathbb{R}^2$$

by

$$T_{\theta, a} \begin{pmatrix} x \\ y \end{pmatrix} = \begin{pmatrix} \cos \theta & \sin \theta \\ -\sin \theta & \cos \theta \end{pmatrix} \begin{pmatrix} x \\ y \end{pmatrix} + \begin{pmatrix} a_1 \\ a_2 \end{pmatrix};$$

thus $T_{\theta, a}$ first rotates the point (x, y) about the origin through an angle θ and then translates by the vector a .

Let $G = \{T_{\theta, a} \mid \theta \in [0, 2\pi), a \in \mathbb{R}^2\}$.

- (i) Let $\theta, \phi \in [0, 2\pi)$ and let $a, b \in \mathbb{R}^2$. Find an expression for the composition $T_{\theta, a} \circ T_{\phi, b}$. Hence show that G is a group under composition of maps (i.e. show that this product is
 - (a) well-defined (i.e. the composition of two elements of G gives another element of G),
 - (b) associative (hint: you already know that composition of functions is associative),
 - (c) that there is an identity element, and (d) that inverses exist).
- (ii) Show that the set of all rotations about the origin is a subgroup of G .
- (iii) Show that the set of all translations is a subgroup of G .

One can show that G is actually the group $\text{Isom}^+(\mathbb{R}^2)$ of orientation preserving isometries of \mathbb{R}^2 with the Euclidean matrices.

§1.5 Tiling the Euclidean plane

A regular n -gon is a polygon with n sides, each side being a geodesic and all sides having the same length, and with all internal angles equal. Thus, a regular 3-gon is an equilateral triangle, a regular 4-gon is a square, and so on. For what values of n can we tile the Euclidean plane by regular n -gons? (By a *tiling*, or *tessellation*, we mean that the plane can be completely covered by regular n -gons of the same size, with no overlapping and no gaps, and with vertices only meeting at vertices.) It is easy to convince oneself that this is only possible for $n = 3, 4, 6$. Thus in Euclidean geometry, there are only three tilings of the

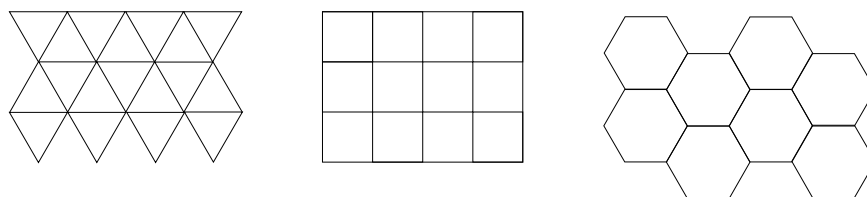

Figure 1.5.4: Tiling the Euclidean plane by regular 3-, 4- and 6-gons

plane by regular n -gons. Hyperbolic geometry is, as we shall see, far more interesting—there are infinitely many such tilings! This is one reason why hyperbolic geometry is studied: the hyperbolic world is richer in structure than the Euclidean world!

Notice that we can associate a group of isometries to a tiling: namely the group of isometries that preserves the tiling. Thus, given a geometric object (a tiling) we can associate to it an algebraic object (a subgroup of isometries). Conversely, as we shall see later, we can go in the opposite direction: given an algebraic object (a subgroup of isometries satisfying some technical hypotheses) we can construct a geometric object (a tiling). Thus we establish a link between two of the main areas of pure mathematics: algebra and geometry.

§1.6 Where we are going

There are several different, but equivalent, ways of constructing hyperbolic geometry. These different constructions are called ‘models’ of hyperbolic geometry. The model that we shall primarily study is the *upper half-plane model* \mathbb{H} . We shall explain how one calculates lengths and distances in \mathbb{H} and we shall describe all isometries of \mathbb{H} .

Later we will study another model of hyperbolic geometry, namely the *Poincaré disc* model. This has some advantages over the upper half-plane model, for example pictures are a lot easier to draw!

We then study trigonometry in hyperbolic geometry. We shall study analogues of familiar results from Euclidean geometry. For example, we shall derive the hyperbolic version of Pythagoras’ Theorem which gives a relationship between the lengths of the sides of a right-angled hyperbolic triangle. We shall also discuss the Gauss-Bonnet Theorem. This is a very beautiful result that can be used to study tessellations of the hyperbolic plane; in particular, we shall prove that there are *infinitely* many tilings of the hyperbolic plane by regular hyperbolic n -gons.

We will then return to studying and classifying isometries of the hyperbolic plane. We shall see that isometries can be classified into three distinct types (elliptic, parabolic and hyperbolic) and we shall explain the differences between them.

As we shall see, the collection of all (orientation preserving) isometries of the hyperbolic plane form a group. We will describe the orientation preserving isometries in terms of Möbius transformation, and denote the group of such by $\text{Möb}(\mathbb{H})$. Certain subgroups of $\text{Möb}(\mathbb{H})$ called *Fuchsian groups* have very interesting properties. We shall explain how one can start with a Fuchsian group and from it construct a tessellation of the hyperbolic plane. Conversely, (with mild and natural conditions) one can start with a tessellation and construct a Fuchsian group. This gives an attractive connection between algebraic structures (Fuchsian groups) and geometric structures (tessellations). To establish this connection we have to use some analysis, so this course demonstrates how one may tie together the three main subjects in pure mathematics into a coherent whole.

§1.7 Appendix: a historical interlude

There are many ways of constructing Euclidean geometry. Klein's Erlangen programme can be used to define it in terms of the Euclidean plane, equipped with the Euclidean distance function and the set of isometries that preserve the Euclidean distance. An alternative way of defining Euclidean geometry is to use the definition due to the Greek mathematician Euclid (c.325BC–c.265BC). In the first of his thirteen volume set 'The Elements', Euclid systematically developed Euclidean geometry by introducing definitions of geometric terms (such as 'line' and 'point'), five 'common notions' concerning magnitudes, and the following five postulates:

- (i) a straight line may be drawn from any point to any other point;
- (ii) a finite straight line may be extended continuously in a straight line;
- (iii) a circle may be drawn with any centre and any radius;
- (iv) all right-angles are equal;
- (v) if a straight line falling on two straight lines makes the interior angles on the same side less than two right-angles, then the two straight lines, if extended indefinitely, meet on the side on which the angles are less than two right-angles.

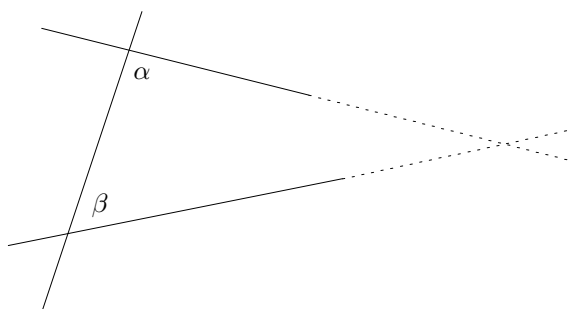

Figure 1.7.5: Euclid's fifth postulate: here $\alpha + \beta < 180^\circ$

The first four postulates are easy to understand; the fifth is more complicated. It is equivalent to the following, which is now known as the *parallel postulate*:

Given any infinite straight line and a point not on that line, there exists a unique infinite straight line through that point and parallel to the given line.

Euclid's Elements has been a standard text on geometry for over two thousand years and throughout its history the parallel postulate has been contentious. The main criticism was that, unlike the other four postulates, it is not sufficiently self-evident to be accepted without proof. Can the parallel postulate be deduced from the previous four postulates? Another surprising feature is that most of plane geometry can be developed without using the parallel postulate (it is not used until Proposition 29 in Book I); this suggested that the parallel postulate is not necessary.

For over two thousand years, many people attempted to prove that the parallel postulate could be deduced from the previous four. However, in the first half of the 19th century, Gauss (1777–1855) proved that this was impossible: the parallel postulate was independent of the other four postulates. He did this by making the remarkable discovery that there exist consistent geometries for which the first four postulates hold, but the parallel postulate fails. In 1824, Gauss wrote ‘The assumption that the sum of the three sides (of a triangle) is smaller than 180 degrees leads to a geometry which is quite different from our (Euclidean) geometry, but which is in itself completely consistent.’ (One can show that the parallel postulate holds if and only if the angle sum of a triangle is always equal to 180 degrees.) This was the first example of a non-Euclidean geometry.

Gauss never published his results on non-Euclidean geometry. However, it was soon rediscovered independently by Lobachevsky in 1829 and by Bolyai in 1832. Today, the non-Euclidean geometry of Gauss, Lobachevsky and Bolyai is called *hyperbolic geometry* and any geometry which is not Euclidean is called *non-Euclidean geometry*.

2. Length and distance in hyperbolic geometry

§2.1 The upper half-plane

There are several different ways of constructing hyperbolic geometry. These different constructions are called ‘models’. In this lecture we will discuss one particularly simple and convenient model of hyperbolic geometry, namely the *upper half-plane model*.

Remark. Throughout this course we will often identify \mathbb{R}^2 with \mathbb{C} , by noting that the point $(x, y) \in \mathbb{R}^2$ can equally well be thought of as the point $z = x + iy \in \mathbb{C}$.

Definition. The *upper half-plane* \mathbb{H} is the set of complex numbers z with positive imaginary part: $\mathbb{H} = \{z \in \mathbb{C} \mid \text{Im}(z) > 0\}$.

Definition. The *circle at infinity* or *boundary* of \mathbb{H} is defined to be the set $\partial\mathbb{H} = \{z \in \mathbb{C} \mid \text{Im}(z) = 0\} \cup \{\infty\}$. That is, $\partial\mathbb{H}$ is the real axis together with the point ∞ .

Remark. What does ∞ mean? It’s just a point that we have ‘invented’ so that it makes sense to write things like $1/x \rightarrow \infty$ as $x \rightarrow 0$ and have the limit as a bona fide point in the space.

(If this bothers you, remember that you are already used to ‘inventing’ numbers; for example irrational numbers such as $\sqrt{2}$ have to be ‘invented’ because rational numbers need not have rational square roots.)

Remark. We will use the conventions that, if $a \in \mathbb{R}$ and $a \neq 0$ then $a/\infty = 0$ and $a/0 = \infty$, and if $b \in \mathbb{R}$ then $b + \infty = \infty$. We leave $0/\infty, \infty/0, \infty/\infty, 0/0, \infty \pm \infty$ undefined.

Remark. We call $\partial\mathbb{H}$ the *circle at infinity* because (at least topologically) it is a circle! We can see this using a process known as *stereographic projection*. Let $K = \{z \in \mathbb{C} \mid |z| = 1\}$ denote the unit circle in the complex plane \mathbb{C} . Define a map

$$\pi : K \rightarrow \mathbb{R} \cup \{\infty\}$$

as follows. For $z \in K \setminus \{i\}$ let L_z be the (Euclidean) straight line passing through i and z ; this line meets the real axis at a unique point, which we denote by $\pi(z)$. We define $\pi(i) = \infty$. The map π is a homeomorphism from K to $\mathbb{R} \cup \{\infty\}$; this is a topological way of saying the K and $\mathbb{R} \cup \{\infty\}$ are ‘the same’. See Figure 2.1.1.

Remark. We call $\partial\mathbb{H}$ the circle at *infinity* because (as we shall see below) points on $\partial\mathbb{H}$ are at an infinite ‘distance’ from any point in \mathbb{H} .

Before we can define distances in \mathbb{H} we need to recall how to calculate path integrals in \mathbb{C} (equivalently, in \mathbb{R}^2).

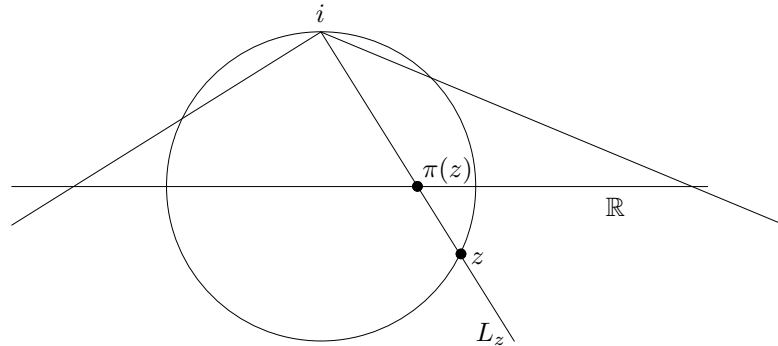

Figure 2.1.1: Stereographic projection. Notice how as z approaches i , the image $\pi(z)$ gets large; this motivates defining $\pi(i) = \infty$.

§2.2 Path integrals

By a *path* σ in the complex plane \mathbb{C} , we mean the image of a continuous function $\sigma(\cdot) : [a, b] \rightarrow \mathbb{C}$, where $[a, b] \subset \mathbb{R}$ is an interval. We will assume that σ is differentiable and that the derivative σ' is continuous. Thus a path is, heuristically, the result of taking a pen and drawing a curve in the plane. We call the points $\sigma(a), \sigma(b)$ the *end-points* of the path σ . We say that a function $\sigma : [a, b] \rightarrow \mathbb{C}$ whose image is a given path is a *parametrisation* of that path. Notice that a path will have lots of different parametrisations.

Example. Define $\sigma_1 : [0, 1] \rightarrow \mathbb{C}$ by $\sigma_1(t) = t + it$ and define $\sigma_2 : [0, 1] \rightarrow \mathbb{C}$ by $\sigma_2(t) = t^2 + it^2$. Then σ_1 and σ_2 are different parametrisations of the same path in \mathbb{C} , namely the straight (Euclidean) line from the origin to $1 + i$.

Let $f : \mathbb{C} \rightarrow \mathbb{R}$ be a continuous function. Then the integral of f along a path σ is defined to be:

$$\int_{\sigma} f = \int_a^b f(\sigma(t)) |\sigma'(t)| dt; \quad (2.2.1)$$

here $|\cdot|$ denotes the usual modulus of a complex number, in this case,

$$|\sigma'(t)| = \sqrt{(\operatorname{Re} \sigma'(t))^2 + (\operatorname{Im} \sigma'(t))^2}.$$

Remark. To calculate the integral of f along the path σ we have to choose a parametrisation of that path. So it appears that our definition of $\int_{\sigma} f$ depends on the choice of parametrisation. One can show, however, that this is not the case: any two parametrisations of a given path will always give the same answer. For this reason, we shall sometimes identify a path with its parametrisation.

Exercise 2.1

Consider the two parametrisations

$$\begin{aligned} \sigma_1 : [0, 2] &\rightarrow \mathbb{H} & : & t \mapsto t + i, \\ \sigma_2 : [1, 2] &\rightarrow \mathbb{H} & : & t \mapsto (t^2 - t) + i. \end{aligned}$$

Verify that these two parametrisations define the same path σ .

Let $f(z) = 1/\operatorname{Im}(z)$. Calculate $\int_{\sigma} f$ using both of these parametrisations.

(The point of this exercise is to show that we can often simplify calculating the integral $\int_{\sigma} f$ of a function f along a path σ by choosing a good parametrisation.)

So far we have assumed that σ is differentiable and has continuous derivative. It will be useful in what follows to allow a slightly larger class of paths.

Definition. A path σ with parametrisation $\sigma(\cdot) : [a, b] \rightarrow \mathbb{C}$ is *piecewise continuously differentiable* if there exists a partition $a = t_0 < t_1 < \cdots < t_{n-1} < t_n = b$ of $[a, b]$ such that $\sigma : [a, b] \rightarrow \mathbb{C}$ is a continuous function and, for each j , $0 \leq j \leq n-1$, $\sigma : (t_j, t_{j+1}) \rightarrow \mathbb{C}$ is differentiable and has continuous derivative.

(Roughly speaking this means that we allow the possibility that the path σ has finitely many ‘corners’.) For example, the path $\sigma(t) = (t, |t|)$, $-1 \leq t \leq 1$ is piecewise continuously differentiable: it is differentiable everywhere except at the origin, where it has a ‘corner’.

To define $\int_{\sigma} f$ for a piecewise continuously differentiable path σ we merely write σ as a finite union of differentiable sub-paths, calculating the integrals along each of these subpaths, and then summing the resulting integrals.

§2.3 Distance in hyperbolic geometry

We are now in a position to define the hyperbolic metric in the upper half-plane model of hyperbolic space. To do this, we first define the length of an arbitrary piecewise continuously differentiable path in \mathbb{H} .

Definition. Let $\sigma : [a, b] \rightarrow \mathbb{H}$ be a path in the upper half-plane $\mathbb{H} = \{z \in \mathbb{C} \mid \text{Im}(z) > 0\}$. Then the *hyperbolic length* of σ is obtained by integrating the function $f(z) = 1/\text{Im}(z)$ along σ , i.e.

$$\text{length}_{\mathbb{H}}(\sigma) = \int_{\sigma} \frac{1}{\text{Im}(z)} = \int_a^b \frac{|\sigma'(t)|}{\text{Im}(\sigma(t))} dt.$$

Examples.

1. Consider the path $\sigma(t) = a_1 + t(a_2 - a_1) + ib$, $0 \leq t \leq 1$ between $a_1 + ib$ and $a_2 + ib$. Then $\sigma'(t) = a_2 - a_1$ and $\text{Im}(\sigma(t)) = b$. Hence

$$\text{length}_{\mathbb{H}}(\sigma) = \int_0^1 \frac{|a_2 - a_1|}{b} dt = \frac{|a_2 - a_1|}{b}.$$

2. Consider the points $-2 + i$ and $2 + i$. By the example above, the length of the horizontal path between them is 4.
3. Now consider a different path from $-2 + i$ to $2 + i$. Consider the piecewise linear path that goes diagonally up from $-2 + i$ to $2i$ and then diagonally down from $2i$ to $2 + i$. A parametrisation of this path is given by

$$\sigma(t) = \begin{cases} (2t - 2) + i(1 + t), & 0 \leq t \leq 1, \\ (2t - 2) + i(3 - t), & 1 \leq t \leq 2. \end{cases}$$

Hence

$$|\sigma'(t)| = \begin{cases} |2 + i| = \sqrt{5}, & 0 \leq t \leq 1, \\ |2 - i| = \sqrt{5}, & 1 \leq t \leq 2, \end{cases}$$

and

$$\text{Im}(\sigma(t)) = \begin{cases} 1 + t, & 0 \leq t \leq 1, \\ 3 - t, & 1 \leq t \leq 2. \end{cases}$$

Hence

$$\begin{aligned} \text{length}_{\mathbb{H}}(\sigma) &= \int_0^1 \frac{\sqrt{5}}{1+t} dt + \int_1^2 \frac{\sqrt{5}}{3-t} dt \\ &= \sqrt{5} \log(1+t) \Big|_0^1 - \sqrt{5} \log(3-t) \Big|_1^2 \\ &= 2\sqrt{5} \log 2, \end{aligned}$$

which is approximately 3.1.

Note that the path from $-2+i$ to $2+i$ in the third example has a *shorter* hyperbolic length than the path from $-2+i$ to $2+i$ in the second example. This suggests that the geodesic (the paths of shortest length) in hyperbolic geometry are very different to the geodesics we are used to in Euclidean geometry.

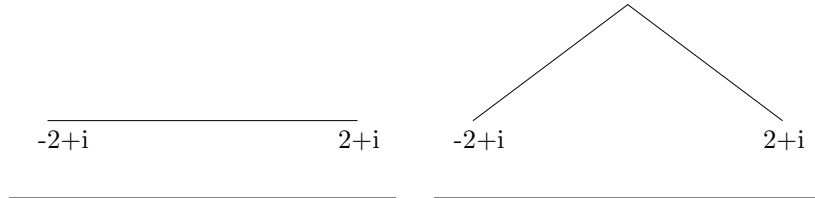

Figure 2.3.2: The first path has hyperbolic length 4, the second path has hyperbolic length 3.1

Exercise 2.2

Consider the points i and ai where $0 < a < 1$.

- (i) Consider the path σ between i and ai that consists of the arc of imaginary axis between them. Find a parametrisation of this path.
- (ii) Show that

$$\text{length}_{\mathbb{H}}(\sigma) = \log 1/a.$$

(Notice that as $a \rightarrow 0$, we have that $\log 1/a \rightarrow \infty$. This motivates why we call $\mathbb{R} \cup \{\infty\}$ the circle at *infinity*.)

§2.4 Hyperbolic distance

We are now in a position to define the hyperbolic distance between two points in \mathbb{H} .

Definition. Let $z, z' \in \mathbb{H}$. We define the *hyperbolic distance* $d_{\mathbb{H}}(z, z')$ between z and z' to be

$$d_{\mathbb{H}}(z, z') = \inf\{\text{length}_{\mathbb{H}}(\sigma) \mid \sigma \text{ is a piecewise continuously differentiable path with end-points } z \text{ and } z'\}.$$

Remark. Thus we consider all piecewise continuously differentiable paths between z and z' , calculate the hyperbolic length of each such path, and then take the shortest. Later we will see that this infimum is achieved by a path (a geodesic), and that this path is unique.

Exercise 2.3

Show that $d_{\mathbb{H}}$ satisfies the *triangle inequality*:

$$d_{\mathbb{H}}(x, z) \leq d_{\mathbb{H}}(x, y) + d_{\mathbb{H}}(y, z), \quad \forall x, y, z \in \mathbb{H}.$$

That is, the distance between two points is increased if one goes via a third point.

3. Circles and lines, Möbius transformations

§3.1 Circles and lines

We are interested in the following problem: given two points w, z in \mathbb{H} , what is the path of shortest length between them? (A path achieving the shortest length is called a *geodesic*.)

The purpose of this lecture is to give a useful method for simultaneously treating circles and lines in the complex plane. This will provide a useful device for calculating and working with the geodesics in \mathbb{H} .

Recall that we can identify \mathbb{R}^2 with \mathbb{C} by identifying the point $(x, y) \in \mathbb{R}^2$ with the complex number $x + iy \in \mathbb{C}$. We are familiar with the equations for a straight line and for a circle in \mathbb{R}^2 ; how can we express these equations in \mathbb{C} ?

§3.2 Lines

First consider a straight (Euclidean) line L in \mathbb{R}^2 . Then the equation of L has the form:

$$ax + by + c = 0 \tag{3.2.1}$$

for some choice of $a, b, c \in \mathbb{R}$. Write $z = x + iy$. Recalling that the complex conjugate of z is given by $\bar{z} = x - iy$ it is easy to see that

$$x = \frac{1}{2}(z + \bar{z}), y = \frac{1}{2i}(z - \bar{z}).$$

Substituting these expressions into (3.2.1) we have

$$a \left(\frac{1}{2}(z + \bar{z}) \right) + b \left(\frac{1}{2i}(z - \bar{z}) \right) + c = 0,$$

and simplifying gives

$$\frac{1}{2}(a - ib)z + \frac{1}{2}(a + ib)\bar{z} + c = 0.$$

Let $\beta = (a - ib)/2$. Then the equation of L is

$$\beta z + \bar{\beta} \bar{z} + c = 0. \tag{3.2.2}$$

§3.3 Circles

Now let C be a circle in \mathbb{R}^2 with centre (x_0, y_0) and radius r . Then C has the equation $(x - x_0)^2 + (y - y_0)^2 = r^2$. Let $z = x + iy$ and $z_0 = x_0 + iy_0$. Then C has the equation $|z - z_0|^2 = r^2$. Recalling that $|w|^2 = w\bar{w}$ for a complex number $w \in \mathbb{C}$, we can write this equation as

$$(z - z_0)(\overline{z - z_0}) = r^2$$

and expanding out gives

$$z\bar{z} - \bar{z}_0 z - z_0 \bar{z} + z_0 \bar{z}_0 - r^2 = 0.$$

Let $\beta = -\bar{z}_0$ and $\gamma = z_0 \bar{z}_0 - r^2 = |z_0|^2 - r^2$. Then C has the equation

$$z\bar{z} + \beta z + \bar{\beta} \bar{z} + \gamma = 0. \quad (3.3.1)$$

Remark. Observe that if we multiply an equation of the form (3.2.2) or (3.3.1) by a non-zero constant then the resulting equation determines the same line or circle.

We can combine (3.2.2) and (3.3.1) as follows:

Proposition 3.3.1

Let A be either a circle or a straight line in \mathbb{C} . Then A has the equation

$$\alpha z\bar{z} + \beta z + \bar{\beta} \bar{z} + \gamma = 0, \quad (3.3.2)$$

where $\alpha, \gamma \in \mathbb{R}$ and $\beta \in \mathbb{C}$.

Remark. Thus equations of the form (3.3.2) with $\alpha = 0$ correspond to straight lines, and equations of the form (3.3.2) with $\alpha \neq 0$ correspond to circles. In the latter case, we can always divide equation (3.3.2) by α to obtain an equation of the form (3.3.1).

Exercise 3.1

Let L be a straight line in \mathbb{C} with equation (3.3.2). Calculate its gradient and intersections with the real and imaginary axes in terms of α, β, γ .

Exercise 3.2

Let C be a circle in \mathbb{C} with equation (3.3.2). Calculate the centre and radius of C in terms of α, β, γ .

§3.4 Geodesics in \mathbb{H}

A particularly important class of circles and lines in \mathbb{C} are those for which all the coefficients in (3.3.2) are real. By examining the above analysis, we have the following result.

Proposition 3.4.1

Let A be a circle or a straight line in \mathbb{C} satisfying the equation $\alpha z\bar{z} + \beta z + \bar{\beta} \bar{z} + \gamma = 0$. Suppose $\beta \in \mathbb{R}$. Then A is either (i) a circle with centre on the real axis, or (ii) a vertical straight line.

We will see below that the geodesics (the paths of shortest hyperbolic length) in the upper half-plane model of hyperbolic space are precisely the intersections of the circles and lines appearing in Proposition 3.4.1 with the upper half-plane. Note that a circle in \mathbb{C} with a real centre meets the real axis orthogonally (meaning: at right-angles); hence the intersection of such a circle with the upper half-plane \mathbb{H} is a semi-circle. Instead of saying ‘circles in \mathbb{C} with real centres’ we shall often say ‘circles in \mathbb{C} that meet \mathbb{R} orthogonally’.

Definition. Let \mathcal{H} denote the set of semi-circles orthogonal to \mathbb{R} and vertical lines in the upper half-plane \mathbb{H} .

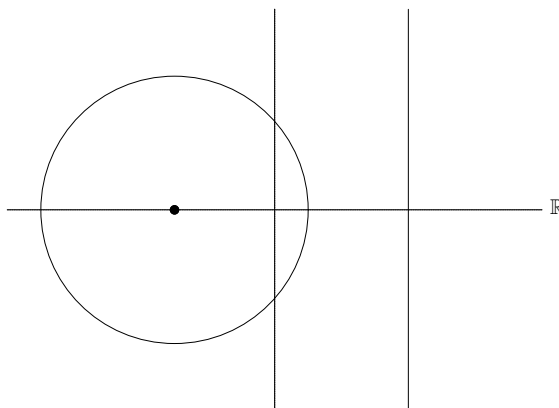

Figure 3.4.1: Circles and lines with real coefficients in (3.3.2)

§3.5 Möbius transformations

Definition. Let $a, b, c, d \in \mathbb{R}$ be such that $ad - bc > 0$ and define the map

$$\gamma(z) = \frac{az + b}{cz + d}.$$

Transformations of \mathbb{H} of this form are called *Möbius transformations of \mathbb{H}* .

Exercise 3.3

Let γ be a Möbius transformation of \mathbb{H} . Show that γ maps \mathbb{H} to itself bijectively and give an explicit expression for the inverse map.

Recall that a group is a set G together with a map $G \times G \rightarrow G$ (denoted by juxtaposition) such that the following axioms hold:

- (i) associativity: $g_1(g_2g_3) = (g_1g_2)g_3$,
- (ii) existence of an identity element: there exists $e \in G$ such that $eg = ge = g$ for all $g \in G$,
- (iii) existence of inverses: for all $g \in G$ there exists $g^{-1} \in G$ such that $gg^{-1} = g^{-1}g = e$.

One of the main aims of this course is to study the set of Möbius transformations. We have the following important result.

Proposition 3.5.1

Let $\text{Möb}(\mathbb{H})$ denote the set of all Möbius transformations of \mathbb{H} . Then $\text{Möb}(\mathbb{H})$ is a group under composition.

Remark. The group operation is composition: given two Möbius transformations $\gamma_1, \gamma_2 \in \Gamma$, we denote by $\gamma_1\gamma_2$ the composition $\gamma_1 \circ \gamma_2$. (*Important note!* This is *not* multiplication of the two complex numbers $\gamma_1(z)\gamma_2(z)$; it is the composition $\gamma_1(\gamma_2(z))$.)

Exercise 3.4

Prove Proposition 3.5.1. (To do this, you must: (i) show that the composition $\gamma_1\gamma_2$ of two Möbius transformations is a Möbius transformation, (ii) check associativity (hint: you

already know that composition of maps is associative), (iii) show that the identity map $z \mapsto z$ is a Möbius transformation, and (iv) show that if $\gamma \in \text{Möb}(\mathbb{H})$ is a Möbius transformation, then γ^{-1} exists and is a Möbius transformation.)

Examples of Möbius transformations of \mathbb{H} include: dilations $z \mapsto kz$ ($k > 0$), translations $z \mapsto z + b$, and the inversion $z \mapsto -1/z$.

Exercise 3.5

Show that dilations, translations and the inversion $z \mapsto -1/z$ are indeed Möbius transformations of \mathbb{H} by writing them in the form $z \mapsto (az + b)/(cz + d)$ for suitable $a, b, c, d \in \mathbb{R}$, $ad - bc > 0$.

Let $H \in \mathcal{H}$ be one of our candidates for a geodesic in \mathbb{H} , namely H is either a semi-circle or a straight line orthogonal to the real axis. We show that a Möbius transformation of \mathbb{H} maps H to another such candidate.

Proposition 3.5.2

Let H be either (i) a semi-circle orthogonal to the real axis, or (ii) a vertical straight line. Let γ be a Möbius transformation of \mathbb{H} . Then $\gamma(H)$ is either a semi-circle orthogonal to the real axis or a vertical straight line.

Proof. By Exercise 3.3 we know that Möbius transformations of \mathbb{H} map the upper half-plane to itself bijectively. Hence it is sufficient to show that γ maps vertical straight lines in \mathbb{C} and circles in \mathbb{C} with real centres to vertical straight lines and circles with real centres.

A vertical line or a circle with a real centre in \mathbb{C} is given by an equation of the form

$$\alpha z\bar{z} + \beta z + \beta\bar{z} + \gamma = 0 \quad (3.5.1)$$

for some $\alpha, \beta, \gamma \in \mathbb{R}$. Let

$$w = \gamma(z) = \frac{az + b}{cz + d}.$$

Then

$$z = \frac{dw - b}{-cw + a}.$$

Substituting this into (3.5.1) we have:

$$\alpha \left(\frac{dw - b}{-cw + a} \right) \left(\frac{d\bar{w} - b}{-c\bar{w} + a} \right) + \beta \left(\frac{dw - b}{-cw + a} \right) + \beta \left(\frac{d\bar{w} - b}{-c\bar{w} + a} \right) + \gamma = 0.$$

Hence

$$\begin{aligned} & \alpha(dw - b)(d\bar{w} - b) + \beta(dw - b)(-c\bar{w} + a) \\ & + \beta(d\bar{w} - b)(-cw + a) + \gamma(-cw + a)(-c\bar{w} + a) = 0 \end{aligned}$$

and simplifying gives

$$\begin{aligned} & (\alpha d^2 - 2\beta cd + \gamma c^2)w\bar{w} + (-\alpha bd + \beta ad + \beta bc - \gamma ac)w \\ & + (-\alpha bd + \beta ad + \beta bc - \gamma ac)\bar{w} + (\alpha b^2 - 2\beta ab + \gamma a^2) = 0 \end{aligned}$$

which is the equation of either a vertical line or a circle with real centre. \square

4. Möbius transformations and geodesics in \mathbb{H}

§4.1 More on Möbius transformations

Recall that we have defined the upper half-plane to be the set $\mathbb{H} = \{z \in \mathbb{C} \mid \text{Im}(z) > 0\}$ and the boundary of \mathbb{H} is defined to be $\partial\mathbb{H} = \{z \in \mathbb{C} \mid \text{Im}(z) = 0\} \cup \{\infty\}$.

Let $a, b, c, d \in \mathbb{R}$ be such that $ad - bc > 0$. Recall that a map of the form

$$\gamma(z) = \frac{az + b}{cz + d}$$

is called a Möbius transformation of \mathbb{H} . Möbius transformations of \mathbb{H} form a group (under composition) which we denote by $\text{Möb}(\mathbb{H})$.

We can extend the action of a Möbius transformation of \mathbb{H} to the circle at infinity $\partial\mathbb{H}$ of \mathbb{H} as follows. Clearly γ maps \mathbb{R} to itself, except at the point $z = -d/c$ where the denominator is undefined. We define $\gamma(-d/c) = \infty$. To determine $\gamma(\infty)$ we write

$$\gamma(z) = \frac{a + b/z}{c + d/z}$$

and notice that $1/z \rightarrow 0$ as $z \rightarrow \infty$. Thus we define $\gamma(\infty) = a/c$. (Note that if $c = 0$ then, as $ad - bc > 0$, we cannot have either $a = 0$ or $d = 0$. Thus we can make sense of the expressions a/c and $-d/c$ when $c = 0$ by setting $a/0 = \infty$ and $-d/0 = \infty$.)

Exercise 4.1

Show that if $ad - bc \neq 0$ then γ maps $\partial\mathbb{H}$ to itself bijectively.

The following important result says that Möbius transformations of \mathbb{H} preserve distance. A bijective map that preserve distance is called an *isometry*. Thus Möbius transformations of \mathbb{H} are isometries of \mathbb{H} .

Proposition 4.1.1

Let γ be a Möbius transformation of \mathbb{H} and let $z, z' \in \mathbb{H}$. Then

$$d_{\mathbb{H}}(\gamma(z), \gamma(z')) = d_{\mathbb{H}}(z, z').$$

Proof. If σ is a path from z to z' then $\gamma \circ \sigma$ is a path from $\gamma(z)$ to $\gamma(z')$. Moreover, any path from $\gamma(z)$ to $\gamma(z')$ arises in this way. Hence to prove the proposition it is sufficient to prove that $\text{length}_{\mathbb{H}}(\gamma \circ \sigma) = \text{length}_{\mathbb{H}}(\sigma)$.

It is an easy calculation to check that for any $z \in \mathbb{H}$

$$|\gamma'(z)| = \frac{ad - bc}{|cz + d|^2}$$

and

$$\text{Im}(\gamma(z)) = \frac{(ad - bc)}{|cz + d|^2} \text{Im}(z).$$

Let $\sigma : [a, b] \rightarrow \mathbb{R}$ be a parametrisation of the path.

Then, by using the chain rule,

$$\begin{aligned}
 \text{length}_{\mathbb{H}}(\gamma \circ \sigma) &= \int_a^b \frac{|(\gamma \circ \sigma)'(t)|}{\text{Im}(\gamma \circ \sigma)(t)} dt \\
 &= \int_a^b \frac{|\gamma'(\sigma(t))||\sigma'(t)|}{\text{Im}(\gamma \circ \sigma)(t)} dt \\
 &= \int_a^b \frac{ad - bc}{|c\sigma(t) + d|^2} |\sigma'(t)| \frac{|c\sigma(t) + d|^2}{ad - bc} \frac{1}{\text{Im}(\sigma(t))} dt \\
 &= \int_a^b \frac{|\sigma'(t)|}{\text{Im}(\sigma(t))} dt \\
 &= \text{length}_{\mathbb{H}}(\sigma).
 \end{aligned}$$

□

Exercise 4.2

Prove the two facts used in the above proof:

$$\begin{aligned}
 |\gamma'(z)| &= \frac{ad - bc}{|cz + d|^2}, \\
 \text{Im}(\gamma(z)) &= \frac{(ad - bc)}{|cz + d|^2} \text{Im}(z).
 \end{aligned}$$

Exercise 4.3

Let $z = x + iy \in \mathbb{H}$ and define $\gamma(z) = -x + iy$. (Note that γ is *not* a Möbius transformation of \mathbb{H} .)

- (i) Show that γ maps \mathbb{H} to \mathbb{H} bijectively.
- (ii) Let $\sigma : [a, b] \rightarrow \mathbb{H}$ be a differentiable path. Show that

$$\text{length}_{\mathbb{H}}(\gamma \circ \sigma) = \text{length}_{\mathbb{H}}(\sigma).$$

Hence conclude that γ is an isometry of \mathbb{H} .

§4.2 The imaginary axis is a geodesic

We are now in a position to calculate the geodesics—the paths of shortest distance—in \mathbb{H} . Our first step is to prove that the imaginary axis is a geodesic.

Proposition 4.2.1

Let $a \leq b$. Then the hyperbolic distance between ia and ib is $\log b/a$. Moreover, the vertical line joining ia to ib is the unique path between ia and ib with length $\log b/a$; any other path from ia to ib has length strictly greater than $\log b/a$.

Proof. Let $\sigma(t) = it$, $a \leq t \leq b$. Then σ is a path from ia to ib . Clearly $\|\sigma'(t)\| = 1$ so that

$$\text{length}_{\mathbb{H}}(\sigma) = \int_a^b \frac{1}{t} dt = \log b/a.$$

Now let $\sigma(t) = x(t) + iy(t) : [0, 1] \rightarrow \mathbb{H}$ be any path from ia to ib . Then

$$\begin{aligned} \text{length}_{\mathbb{H}}(\sigma) &= \int_0^1 \frac{\sqrt{x'(t)^2 + y'(t)^2}}{y(t)} dt \\ &\geq \int_0^1 \frac{|y'(t)|}{y(t)} dt \\ &\geq \int_0^1 \frac{y'(t)}{y(t)} dt \\ &= \log y(t) \Big|_0^1 \\ &= \log b/a. \end{aligned}$$

Hence any path joining ia to ib has hyperbolic length at least $\log b/a$, with equality precisely when $x'(t) = 0$. This can only happen when $x(t)$ is constant, i.e. σ is the vertical line joining ia to ib . \square

§4.3 Mapping to the imaginary axis

So far we have seen that the imaginary axis is a geodesic. We claim that any vertical straight line and any circle meeting the real axis orthogonally is also a geodesic. The first step in proving this is to show that one of our candidate geodesics can be mapped onto the imaginary axis by a Möbius transformation of \mathbb{H} .

Remark. Our candidates for the geodesics can be described uniquely by their end points in $\partial\mathbb{H}$. Semi-circles orthogonal to \mathbb{R} have two end points in \mathbb{R} , and vertical lines have one end point in \mathbb{R} and the other at ∞ .

Lemma 4.3.1

Let $H \in \mathcal{H}$. Then there exists $\gamma \in \text{Möb}(\mathbb{H})$ such that γ maps H bijectively to the imaginary axis.

Proof. If H is the vertical line $\text{Re}(z) = a$ then the translation $z \mapsto z - a$ is a Möbius transformation of \mathbb{H} that maps H to the imaginary axis $\text{Re}(z) = 0$.

Let H be a semi-circle with end points $\zeta_-, \zeta_+ \in \mathbb{R}$, $\zeta_- < \zeta_+$. Consider the map

$$\gamma(z) = \frac{z - \zeta_+}{z - \zeta_-}.$$

As $-\zeta_- + \zeta_+ > 0$ this is a Möbius transformation of \mathbb{H} . By Lecture 3 we know that $\gamma(H) \in \mathcal{H}$. Clearly $\gamma(\zeta_+) = 0$ and $\gamma(\zeta_-) = \infty$, so $\gamma(H)$ must be the imaginary axis. \square

Exercise 4.4

Let $H_1, H_2 \in \mathcal{H}$. Show that there exists a Möbius transformation of \mathbb{H} that maps H_1 to H_2 .

5. More on the geodesics in \mathbb{H}

§5.1 Recap

Recall that we are trying to find the geodesics—the paths of shortest length—in \mathbb{H} . We claim that the geodesics are given by the vertical half-lines in \mathbb{H} and the semi-circles in \mathbb{H} that meet the real axis orthogonally; equivalently, these paths are the intersection with \mathbb{H} of solutions to equations of the form

$$\alpha z\bar{z} + \beta z + \beta\bar{z} + \gamma = 0$$

where $\alpha, \beta, \gamma \in \mathbb{R}$. We denote the set of such paths by \mathcal{H} .

So far we have proved the following facts:

- (i) Möbius transformations of \mathbb{H} map an element of \mathcal{H} to an element of \mathcal{H} ;
- (ii) Möbius transformations of \mathbb{H} are isometries (meaning: they preserve distance, $d_{\mathbb{H}}(\gamma(z), \gamma(z')) = d_{\mathbb{H}}(z, z')$ for all $z, z' \in \mathbb{H}$);
- (iii) the imaginary axis is a geodesic and, moreover, it is the unique geodesic between ia and ib , ($a, b \in \mathbb{R}, a, b > 0$);
- (iv) given any element H of \mathcal{H} we can find a Möbius transformation of \mathbb{H} that maps H to the imaginary axis.

The goal of this lecture is to prove that the geodesics are what we claim they are and, moreover, that given any two points $z, z' \in \mathbb{H}$ there exists a unique geodesic between them.

§5.2 Geodesics in \mathbb{H}

Our first observation is a generalisation of fact (iv) above. It says that given any geodesic H and any point z_0 on that geodesic, we can find a Möbius transformation of \mathbb{H} that maps H to the imaginary axis and z_0 to the point i . Although this result is not needed to prove that the geodesics are what we claim they are, this result will prove extremely useful in future lectures. Recall that in Euclidean geometry, there is (usually) no loss in generalisation to assume that a given straight line is an arc of the x -axis and starts at the origin (if you draw a triangle then instinctively you usually draw it so that one side is horizontal). This result is the hyperbolic analogue of this observation.

Lemma 5.2.1

Let $H \in \mathcal{H}$ and let $z_0 \in H$. Then there exists a Möbius transformation of \mathbb{H} that maps H to the imaginary axis and z_0 to i .

Proof. Proceed as in the proof of Lemma 4.3.1 to obtain a Möbius transformation $\gamma_1 \in \text{Möb}(\mathbb{H})$ mapping H to the imaginary axis. (Recall how we did this: There are two cases, (i) H is a vertical half-line, (ii) H is a semi-circle orthogonal to the real axis. In case (i) we

take γ to be a translation. In case (ii) we assume that H has endpoints $\zeta_- < \zeta_+$ and then define $\gamma(z) = (z - \zeta_+)/ (z - \zeta_-)$.

Now $\gamma_1(z_0)$ lies on the imaginary axis. For any $k > 0$, the Möbius transformation $\gamma_2(z) = kz$ maps the imaginary axis to itself. For a suitable choice of $k > 0$ it maps $\gamma_1(z_0)$ to i . The composition $\gamma = \gamma_2 \circ \gamma_1$ is the required Möbius transformation. \square

Exercise 5.1

Let $H_1, H_2 \in \mathcal{H}$ and let $z_1 \in H_1, z_2 \in H_2$. Show that there exists a Möbius transformation $\gamma \in \text{Möb}(\mathbb{H})$ such that $\gamma(H_1) = H_2$ and $\gamma(z_1) = z_2$. In particular, conclude that given $z_1, z_2 \in \mathbb{H}$, one can find a Möbius transformation $\gamma \in \text{Möb}(\mathbb{H})$ such that $\gamma(z_1) = z_2$.

(Hint: you know that there exists $\gamma_1 \in \text{Möb}(\mathbb{H})$ that maps H_1 to the imaginary axis and z_1 to i ; similarly you know that there exists $\gamma_2 \in \text{Möb}(\mathbb{H})$ that maps H_2 to the imaginary axis and z_2 to i . What does γ_2^{-1} do?)

Theorem 5.2.2

The geodesics in \mathbb{H} are the semi-circles orthogonal to the real axis and the vertical straight lines. Moreover, given any two points in \mathbb{H} there exists a unique geodesic passing through them.

Proof. Let $z, z' \in \mathbb{H}$. Then we can always find some element of $H \in \mathcal{H}$ containing z, z' . Apply the Möbius transformation $\gamma \in \text{Möb}(\mathbb{H})$ constructed in Lemma 4.3.1 so that $\gamma(z), \gamma(z')$ lie on the imaginary axis. By Proposition 4.2.1 the imaginary axis is the unique geodesic passing through $\gamma(z)$ and $\gamma(z')$. By applying γ^{-1} we see that H is the unique geodesic passing through z, z' . \square

Exercise 5.2

For each of the following pairs of points, describe (either by giving an equation in the form $\alpha z\bar{z} + \beta z + \beta\bar{z} + \gamma$, or in words) the geodesic between them:

- (i) $-3 + 4i, -3 + 5i$,
- (ii) $-3 + 4i, 3 + 4i$,
- (iii) $-3 + 4i, 5 + 12i$.

§5.3 Isometries of \mathbb{H}

We have already seen that Möbius transformations of \mathbb{H} are isometries of \mathbb{H} . Are there any others?

First let us recall the Euclidean case. In Lecture 1 we stated that the isometries of the Euclidean plane \mathbb{R}^2 are:

- (i) translations of the form $\tau_{(a_1, a_2)}(x, y) = (x + a_1, y + a_2)$,
- (iii) rotations of the plane,
- (iv) reflections in a straight line (for example, reflection in the y -axis, $(x, y) \mapsto (-x, y)$),

together with the identity. Translations and rotations are orientation-preserving whereas reflections are orientation-reversing.

Proposition 4.1.1 shows that Möbius transformations of \mathbb{H} are isometries. Exercise 4.3 shows that there are other isometries. However, note that Möbius transformations of \mathbb{H} are

also orientation-preserving (roughly this means the following: Let Δ be a hyperbolic triangle in \mathbb{H} with vertices A, B, C , labelled anticlockwise. Then γ is orientation-preserving if $\gamma(\Delta)$ has vertices at $\gamma(A), \gamma(B), \gamma(C)$ and these are still labelled anti-clockwise). Note that $\gamma(z) = -x + iy$ reflects the point z in the imaginary axis, and is orientation-reversing. One can show that all orientation-preserving isometries of \mathbb{H} are Möbius transformations of \mathbb{H} , and all orientation-reversing isometries of \mathbb{H} are the composition of a Möbius transformation of \mathbb{H} and the reflection in the imaginary axis.

§5.4 Euclid’s parallel postulate fails

We can now see that Euclid’s parallel postulate fails in \mathbb{H} . That is, given any geodesic and any point not on that geodesic there exist *infinitely* many geodesics through that point that do not intersect the given geodesic (see Figure 5.4.1).

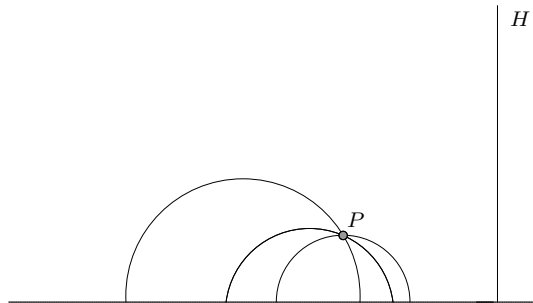

Figure 5.4.1: There are infinitely many geodesics through P that do not intersect the geodesic H

§5.5 The distance between arbitrary points

So far, we only have a formula for the hyperbolic distance between points of the form ia and ib . We can now give a formula for the distance between any two points in \mathbb{H} . We will need the following (easily proved) lemma.

Lemma 5.5.1

Let γ be a Möbius transformation of \mathbb{H} . Then for all $z, w \in \mathbb{H}$ we have

$$|\gamma(z) - \gamma(w)| = |z - w| |\gamma'(z)|^{1/2} |\gamma'(w)|^{1/2}.$$

Proposition 5.5.2

Let $z, w \in \mathbb{H}$. Then

$$\cosh d_{\mathbb{H}}(z, w) = 1 + \frac{|z - w|^2}{2 \operatorname{Im}(z) \operatorname{Im}(w)}. \tag{5.5.1}$$

Exercise 5.3

Prove Proposition 5.5.2 using the following steps. For $z, w \in \mathbb{H}$ let

$$\begin{aligned} \text{LHS}(z, w) &= \cosh d_{\mathbb{H}}(z, w) \\ \text{RHS}(z, w) &= 1 + \frac{|z - w|^2}{2 \operatorname{Im}(z) \operatorname{Im}(w)} \end{aligned}$$

denote the left- and right-hand sides of (5.5.1) respectively. We want to show that $\text{LHS}(z, w) = \text{RHS}(z, w)$ for all $z, w \in \mathbb{H}$.

- (i) Let $\gamma \in \text{Möb}(\mathbb{H})$ be a Möbius transformation of \mathbb{H} . Using the fact that γ is an isometry, prove that

$$\text{LHS}(\gamma(z), \gamma(w)) = \text{LHS}(z, w).$$

Using Exercise 4.2 and Lemma 5.5.1, prove that

$$\text{RHS}(\gamma(z), \gamma(w)) = \text{RHS}(z, w).$$

- (ii) Let H denote the geodesic passing through z, w . By Lemma 4.3.1, there exists a Möbius transformation $\gamma \in \text{Möb}(\mathbb{H})$ that maps H to the imaginary axis. Let $\gamma(z) = ia$ and $\gamma(w) = ib$. Prove, using the fact that $d_{\mathbb{H}}(ia, ib) = \log b/a$ if $a < b$, that for this choice of γ we have

$$\text{LHS}(\gamma(z), \gamma(w)) = \text{RHS}(\gamma(z), \gamma(w)).$$

- (iii) Conclude that $\text{LHS}(z, w) = \text{RHS}(z, w)$ for all $z, w \in \mathbb{H}$.

Exercise 5.4

A hyperbolic circle C with centre $z_0 \in \mathbb{H}$ and radius $r > 0$ is defined to be the set of all points of hyperbolic distance r from z_0 . Using (5.5.1), show that a hyperbolic circle is a Euclidean circle (i.e. an ordinary circle) but with a different centre and radius.

Exercise 5.5

Recall that we defined the hyperbolic distance by first defining the hyperbolic length of a piecewise continuously differentiable path σ :

$$\text{length}_{\mathbb{H}}(\sigma) = \int \frac{|\sigma'(t)|}{\text{Im}(\sigma(t))} dt = \int_{\sigma} \frac{1}{\text{Im}(z)}. \quad (5.5.2)$$

We then saw that the Möbius transformations of \mathbb{H} are isometries.

Why did we choose the function $1/\text{Im } z$ in (5.5.2)? In fact, one can choose *any* positive function and use it to define the length of a path, and hence the distance between two points. However, the geometry that one gets may be very complicated (for example, there may be many geodesics between two points); alternatively, the geometry may not be very interesting (for example, there may be very few symmetries, i.e. the group of isometries is very small).

The group of Möbius transformations of \mathbb{H} is, as we shall see, a very rich group with lots of interesting structure. The point of this exercise is to show that if we want the Möbius transformations of \mathbb{H} to be isometries then we must define hyperbolic length by (5.5.2).

Let $\rho : \mathbb{H} \rightarrow \mathbb{R}$ be a continuous positive function. Define the ρ -length of a path $\sigma : [a, b] \rightarrow \mathbb{H}$ to be

$$\text{length}_{\rho}(\sigma) = \int_{\sigma} \rho = \int_a^b \rho(\sigma(t)) |\sigma'(t)| dt.$$

- (i) Suppose that length_{ρ} is invariant under Möbius transformations of \mathbb{H} , i.e. if $\gamma \in \text{Möb}(\mathbb{H})$ then $\text{length}_{\rho}(\gamma \circ \sigma) = \text{length}_{\rho}(\sigma)$. Prove that

$$\rho(\gamma(z)) |\gamma'(z)| = \rho(z). \quad (5.5.3)$$

(Hint: you may use the fact that if f is a continuous function such that $\int_{\sigma} f = 0$ for every path σ then $f = 0$.)

- (ii) By taking $\gamma(z) = z + b$ in (5.5.3), deduce that $\rho(z)$ depends only on the imaginary part of z . Hence we may write ρ as $\rho(y)$ where $z = x + iy$.
- (iii) By taking $\gamma(z) = kz$ in (5.5.3), deduce that $\rho(y) = c/y$ for some constant $c > 0$.

Hence, up to a normalising constant c , we see that if we require the Möbius transformations of \mathbb{H} to be isometries, then the distance in \mathbb{H} must be given by the formula we introduced in Lecture 2.

§5.6 Angles

Suppose that we have two paths σ_1 and σ_2 that intersect at the point $z \in \mathbb{H}$. By choosing appropriate parametrisations of the paths, we can assume that $z = \sigma_1(0) = \sigma_2(0)$. The angle between σ_1 and σ_2 at z is defined to be the angle between their tangent vectors at the point of intersection and is denoted by $\angle \sigma'_1(0), \sigma'_2(0)$,

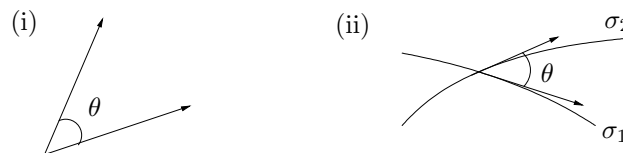

Figure 5.6.2: (i) The angle between two vectors, (ii) The angle between two paths at a point of intersection

It will be important for us to know that Möbius transformations preserve angles. That is, if σ_1 and σ_2 are two paths that intersect at z with angle θ , then the paths $\gamma\sigma_1$ and $\gamma\sigma_2$ intersect at $\gamma(z)$ also with angle θ . If a transformation preserves angles, then it is called *conformal*.

Proposition 5.6.1

Let $\gamma \in \text{Möb}(\mathbb{H})$ be a Möbius transformation of \mathbb{H} . Then γ is conformal.

We can use the (Euclidean) cosine rule to calculate the angle between two geodesics.

Exercise 5.6

- (i) Let C_1 and C_2 be two circles in \mathbb{R}^2 with centres c_1, c_2 and radii r_1, r_2 , respectively. Suppose C_1 and C_2 intersect. Let θ denote the internal angle at the point of intersection (see Figure 5.6). Show that

$$\cos \theta = \frac{|c_1 - c_2|^2 - (r_1^2 + r_2^2)}{2r_1 r_2}.$$

- (ii) Consider the geodesic between -6 and 6 and the geodesic between $4\sqrt{2}$ and $6\sqrt{2}$, as illustrated in Figure 5.6). Both of these geodesics are semi-circles. Find the centre and radius of each semi-circle. Hence use the result in (i) to calculate the angle ϕ .

In the case where one geodesic is vertical and the other is a semicircle, the following exercise tells us how to calculate the angle between them.

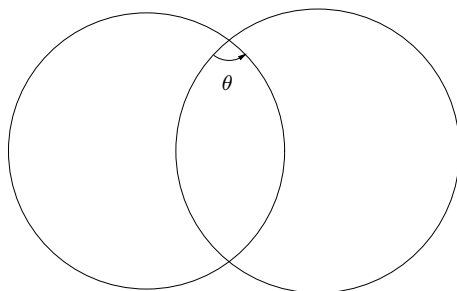

Figure 5.6.3: The internal angle between two circles

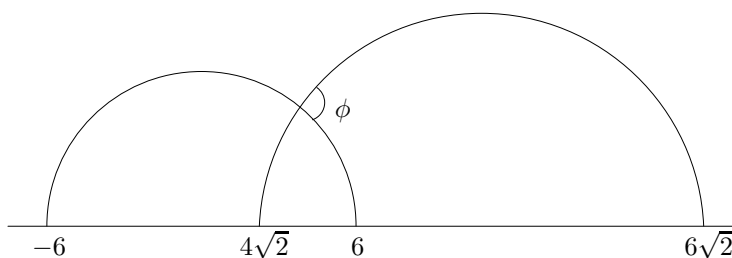

Figure 5.6.4: Two geodesics intersecting with angle ϕ

Exercise 5.7

Suppose that two geodesics intersect as illustrated in Figure 5.6.5. Show that

$$\sin \theta = \frac{2ab}{a^2 + b^2}, \quad \cos \theta = \frac{b^2 - a^2}{a^2 + b^2}.$$

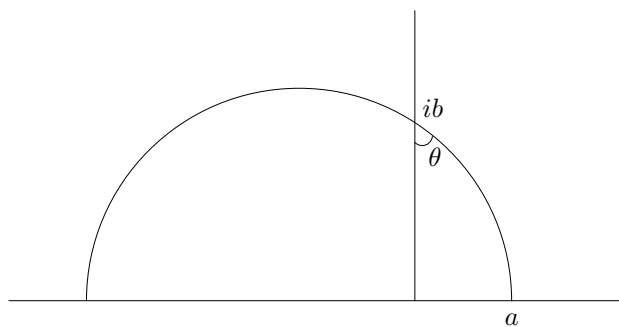

Figure 5.6.5: The angle between two geodesics in the case where one is a vertical straight line

§5.7 Pythagoras' Theorem

In Euclidean geometry, Pythagoras' Theorem gives a relationship between the three side lengths of a right-angled triangle. Here we prove an analogous result in hyperbolic geometry using Proposition 5.5.2.

Theorem 5.7.1 (Pythagoras' Theorem for hyperbolic triangles)

Let Δ be a right-angled triangle in \mathbb{H} with internal angles $\alpha, \beta, \pi/2$ and opposing sides with lengths a, b, c . Then

$$\cosh c = \cosh a \cosh b. \quad (5.7.1)$$

Remark. If a, b, c are all very large then approximately we have $c \approx a + b - \log 2$. Thus in hyperbolic geometry (and in contrast with Euclidean geometry), the length of the hypotenuse is *not* substantially shorter than the sum of the lengths of the other two sides.

Proof. Let Δ be a triangle satisfying the hypotheses of the theorem. By applying a Möbius transformation of \mathbb{H} , we may assume that the vertex with internal angle $\pi/2$ is at i and that the side of length b lies along the imaginary axis. It follows that the side of length a lies along the geodesic given by the semi-circle centred at the origin with radius 1. Therefore, the other vertices of Δ can be taken to be at ki for some $k > 0$ and at $s + it$, where $s + it$ lies on the circle centred at the origin and of radius 1. See Figure 5.7.6.

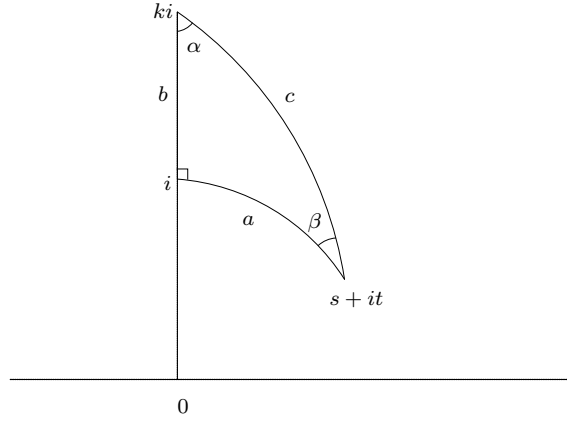

Figure 5.7.6: Without loss of generality, we can assume that Δ has vertices at i, ki and $s + it$

Recall from Proposition 5.5.2 that for any $z, w \in \mathbb{H}$

$$\cosh d_{\mathbb{H}}(z, w) = 1 + \frac{|z - w|^2}{2 \operatorname{Im}(z) \operatorname{Im}(w)}.$$

Applying this formula to the the three sides of Δ we have:

$$\cosh a = 1 + \frac{|s + i(t - 1)|^2}{2t} = 1 + \frac{s^2 + (t - 1)^2}{2t} = \frac{1}{t}, \quad (5.7.2)$$

$$\cosh b = 1 + \frac{(k - 1)^2}{2k} = \frac{1 + k^2}{2k}, \quad (5.7.3)$$

$$\cosh c = 1 + \frac{|s + i(t - k)|^2}{2tk} = 1 + \frac{s^2 + (t - k)^2}{2tk} = \frac{1 + k^2}{2tk}, \quad (5.7.4)$$

where to obtain (5.7.2) and (5.7.4) we have used the fact that $s^2 + t^2 = 1$, as $s + it$ lies on the unit circle.

Combining (5.7.2), (5.7.3) and (5.7.4) we see that

$$\cosh c = \cosh a \cosh b,$$

proving the theorem. \square

§5.8 Area

Let $A \subset \mathbb{H}$ be a subset of the upper half-plane. The hyperbolic area of A is defined to be the double integral

$$\text{Area}_{\mathbb{H}}(A) = \int \int_A \frac{1}{y^2} dx dy = \int \int_A \frac{1}{\text{Im}(z)^2} dz. \quad (5.8.1)$$

Again, it will be important for us to know that Möbius transformations preserve area. This is contained in the following result.

Proposition 5.8.1

Let $A \subset \mathbb{H}$ and let $\gamma \in \text{Möb}(\mathbb{H})$ be a Möbius transformation of \mathbb{H} . Then

$$\text{Area}_{\mathbb{H}}(\gamma(A)) = \text{Area}_{\mathbb{H}}(A).$$

Remark. There are some measure-theoretic technicalities at work here that we have chosen, for simplicity, to ignore. It turns out that it is not possible to define the area of every subset A of \mathbb{H} . One needs to assume, for example, that A is a Borel set. All open subset and all closed subsets of \mathbb{H} (see §13.1) are Borel sets, and so it makes sense to talk about the area of these.

§5.9 Appendix: Towards Riemannian geometry

§5.9.1 Introduction

The aim of this appendix is to explain why hyperbolic angles and Euclidean angles are the same, why Möbius transformations are conformal, why we define hyperbolic area as we do, and why Möbius transformations are area-preserving. This is somewhat outside the scope of the course as it is best explained using ideas that lead on to a more general construction called Riemannian geometry of which hyperbolic geometry is one particular case.

§5.9.2 Angles

We defined angles in the upper half-plane model of hyperbolic geometry to be the same as angles in Euclidean geometry. To see why this is the case (and, indeed, to see how the concept of ‘angle’ is actually defined) we need to make a slight diversion and recall some facts from linear algebra.

Let us first describe how angles are defined in the Euclidean plane \mathbb{R}^2 . Let $(x, y) \in \mathbb{R}^2$ and suppose that $v = (v_1, v_2)$ and $w = (w_1, w_2)$ are two vectors at the point (x, y) . We define an *inner product* $\langle \cdot, \cdot \rangle$ between two vectors v, w that meet at the point (x, y) by

$$\langle v, w \rangle_{(x,y)} = v_1 w_1 + v_2 w_2.$$

We also define the *norm* of a vector v at the point (x, y) by

$$\|v\|_{(x,y)} = \sqrt{\langle v, v \rangle_{(x,y)}} = \sqrt{v_1^2 + v_2^2}.$$

The Cauchy Schwartz inequality says that

$$|\langle v, w \rangle_{(x,y)}| \leq \|v\|_{(x,y)} \|w\|_{(x,y)}.$$

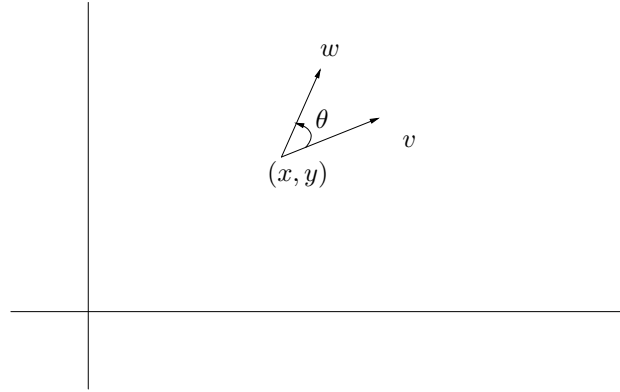

Figure 5.9.7: The angle between two vectors v, w and the point (x, y) .

We define the (*Euclidean*) angle $\theta = \angle v, w$ between the vectors v, w meeting at the point (x, y) by

$$\cos \theta = \frac{\langle v, w \rangle_{(x,y)}}{\|v\|_{(x,y)} \|w\|_{(x,y)}}.$$

(Note that we are not interested in the sign of the angle: for our purposes angles can be measured either clockwise or anti-clockwise so that $\angle v, w = \angle w, v$.)

In the upper half-plane, we have a similar definition of angle, but we use a different inner product. Suppose $z \in \mathbb{H}$ is a point in the upper half-plane. Let v, w be two vectors that meet at z . We define the *inner product* of v, w at z by

$$\langle v, w \rangle_z = \frac{1}{\text{Im}(z)^2} (v_1 w_1 + v_2 w_2)$$

(that is, the usual Euclidean inner product but scaled by a factor of $1/\text{Im}(z)^2$.) We also define the *norm* of the vector v at z by

$$\|v\|_z = \sqrt{\langle v, v \rangle_z} = \frac{1}{\text{Im}(z)} \sqrt{v_1^2 + v_2^2}.$$

The Cauchy-Schwartz inequality still holds and we can define the angle $\theta = \angle v, w$ between two vectors v, w meeting at z by

$$\cos \theta = \frac{\langle v, w \rangle_z}{\|v\|_z \|w\|_z}. \quad (5.9.1)$$

Notice that, as the terms involving $\text{Im}(z)$ cancel, this definition of angle coincides with the Euclidean definition.

Suppose that we have two paths σ_1, σ_2 that intersect at the point $z = \sigma_1(0) = \sigma_2(0)$. Then we define the angle between σ_1, σ_2 to be

$$\angle \sigma_1'(0), \sigma_2'(0),$$

that is, the angle between two paths is the angle between their tangent vectors at the point of intersection.

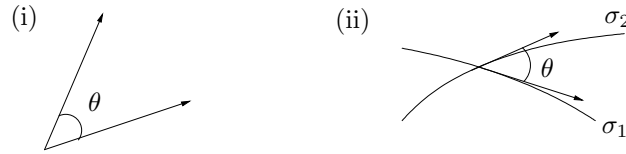

Figure 5.9.8: (i) The angle between two vectors, (ii) The angle between two paths at a point of intersection

§5.9.3 Conformal transformations

Definition. A map $\gamma : \mathbb{H} \rightarrow \mathbb{H}$ is said to be *conformal* if it preserves angles between paths. That is, if σ_1, σ_2 intersect at z with angle θ , then the angle between the intersection of the paths $\gamma\sigma_1, \gamma\sigma_2$ at $\gamma(z)$ is also θ .

We will see that Möbius transformations of \mathbb{H} are conformal. To see this, we need to recall the following standard result from complex analysis.

Proposition 5.9.1 (Cauchy-Riemann equations)

Let $f : \mathbb{C} \rightarrow \mathbb{C}$ be a (complex) differentiable function. Write f as $f(x + iy) = u(x, y) + iv(x, y)$. Then

$$\frac{\partial u}{\partial x} = \frac{\partial v}{\partial y}, \quad \frac{\partial u}{\partial y} = -\frac{\partial v}{\partial x}.$$

Proposition 5.9.2

Let $\gamma \in \text{Möb}(\mathbb{H})$ be a Möbius transformation of \mathbb{H} . Then γ is conformal.

Proof (sketch). Let γ be a Möbius transformation of \mathbb{H} and write γ in terms of its real and imaginary parts as $\gamma(x + iy) = u(x, y) + iv(x, y)$. Regarding \mathbb{H} as a subset of \mathbb{C} , we can view γ as a map $\mathbb{R}^2 \rightarrow \mathbb{R}^2$. The matrix of partial derivatives of γ is given by

$$D\gamma(z) = \begin{pmatrix} u_x & u_y \\ v_x & v_y \end{pmatrix}$$

where we write $u_x = \partial u / \partial x$.

Let σ_1, σ_2 be paths that intersect at $z = \sigma_1(0) = \sigma_2(0)$ with tangent vectors $\sigma_1'(0), \sigma_2'(0)$. Then $\gamma\sigma_1$ and $\gamma\sigma_2$ are paths that intersect at $\gamma(z)$ with tangent vectors $D\gamma(z)\sigma_1'(0), D\gamma(z)\sigma_2'(0)$ where $D\gamma(z)$ denotes the matrix of partial derivatives of γ at z .

Let $v = (v_1, v_2), w = (w_1, w_2)$ be two vectors at the point z . By (5.9.1) it is sufficient to prove that

$$\frac{\langle D\gamma(v), D\gamma(w) \rangle_{\gamma(z)}}{\|D\gamma(v)\|_{\gamma(z)} \|D\gamma(w)\|_{\gamma(z)}} = \frac{\langle v, w \rangle_z}{\|v\|_z \|w\|_z}.$$

Notice that

$$\langle D\gamma(v), D\gamma(w) \rangle_{\gamma(z)} = \frac{1}{\text{Im}(\gamma(z))} \langle v, (D\gamma)^T D\gamma(w) \rangle$$

where $(D\gamma)^T$ denotes the transpose of $D\gamma$. Using the Cauchy-Riemann equations, we see that

$$(D\gamma^T)D\gamma = \begin{pmatrix} u_x & v_x \\ u_y & v_y \end{pmatrix} \begin{pmatrix} u_x & u_y \\ v_x & v_y \end{pmatrix} = \begin{pmatrix} u_x^2 + u_y^2 & 0 \\ 0 & u_x^2 + u_y^2 \end{pmatrix},$$

a scalar multiple of the identity matrix. It is straight-forward to see that this implies the claim. \square

Remark. In fact, we have proved that any complex differentiable function with non-vanishing derivative is conformal.

§5.9.4 Hyperbolic area

Before we define hyperbolic area, let us motivate the definition by recalling how the hyperbolic length of a path is defined.

Let $\sigma : [a, b] \rightarrow \mathbb{H}$ be a path. Then the hyperbolic length of σ is given by

$$\text{length}_{\mathbb{H}}(\sigma) = \int_{\sigma} \frac{1}{\text{Im}(z)} = \int_a^b \frac{|\sigma'(t)|}{\text{Im}(\sigma(t))} dt.$$

In light of the above discussion, we can write this as

$$\text{length}_{\mathbb{H}}(\sigma) = \int_a^b \|\sigma'(t)\|_{\sigma(t)} dt;$$

Intuitively, we are approximating the path σ by vectors of length $\|\sigma'(t)\|_{\sigma(t)}$ and then integrating.

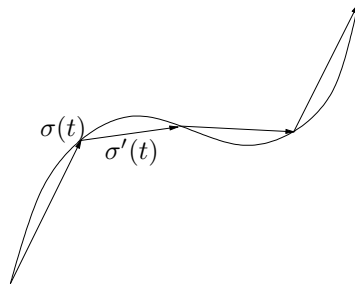

Figure 5.9.9: The path σ can be approximated at the point $\sigma(t)$ by the tangent vector $\sigma'(t)$.

Let $A \subset \mathbb{H}$ be a subset of the upper half-plane. How can we intuitively define the area of A ? If we take a point $z \in A$ then we can approximate the area near z by taking a small rectangle with sides dx, dy . The area of this rectangle is given by the product of the lengths of the sides, namely

$$\frac{1}{\text{Im}(z)^2} dx dy.$$

This suggests that we define the hyperbolic area of a subset $A \subset \mathbb{H}$ to be

$$\text{Area}_{\mathbb{H}}(A) = \int \int_A \frac{1}{\text{Im}(z)^2} dz = \int \int_A \frac{1}{y^2} dx dy.$$

By definition, isometries of the hyperbolic plane \mathbb{H} preserve lengths. However, it is not clear that they also preserve area. That they do is contained in the following result:

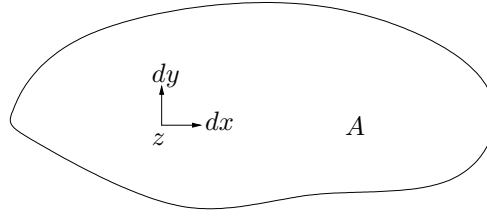

Figure 5.9.10: The area of A can be approximated at the point z by a small rectangle with sides dx, dy .

Proposition 5.9.3

Let $A \subset \mathbb{H}$ and let $\gamma \in \text{Möb}(\mathbb{H})$ be a Möbius transformation of \mathbb{H} . Then

$$\text{Area}_{\mathbb{H}}(\gamma(A)) = \text{Area}_{\mathbb{H}}(A).$$

Proof (sketch). Let $\gamma(z) = (az + b)/(cz + d), ad - bc > 0$ be a Möbius transformation.

Let $h : \mathbb{R}^2 \rightarrow \mathbb{R}$ and recall the change-of-variables formula:

$$\int \int_{\gamma(A)} h(x, y) dx dy = \int \int_A h \circ \gamma(x, y) |\det(D\gamma)| dx dy \tag{5.9.2}$$

where $D\gamma$ is the matrix of partial derivatives of γ .

Using the Cauchy-Riemann equations (and brute force!), one can check that

$$\det(D\gamma) = \frac{(ad - bc)^2}{((cx + d)^2 + c^2y^2)^2}.$$

The hyperbolic area of A is determined by setting $h(x, y) = 1/y^2$ in (5.9.2). In this case, we have that

$$h \circ \gamma(x, y) = \left(\frac{(cx + d)^2 + c^2y^2}{(ad - bc)y} \right)^2$$

and it follows that

$$\begin{aligned} \text{Area}_{\mathbb{H}}(\gamma(A)) &= \int \int_{\gamma(A)} h(x, y) dx dy \\ &= \int \int_A h \circ \gamma(x, y) |\det(D\gamma)| dx dy \\ &= \int \int_A \left(\frac{(cx + d)^2 + c^2y^2}{(ad - bc)y} \right)^2 \left(\frac{ad - bc}{(cx + d)^2 + c^2y^2} \right)^2 dx dy \\ &= \int \int_A \frac{1}{y^2} dx dy \\ &= \text{Area}_{\mathbb{H}}(A). \end{aligned}$$

□

6. The Poincaré disc model

§6.1 Introduction

So far we have studied the upper half-plane model of hyperbolic geometry. There are several other ways of constructing hyperbolic geometry; here we describe the Poincaré disc model.

Definition. The disc $\mathbb{D} = \{z \in \mathbb{C} \mid |z| < 1\}$ is called the *Poincaré disc*. The circle $\partial\mathbb{D} = \{z \in \mathbb{C} \mid |z| = 1\}$ is called the *circle at ∞* or *boundary* of \mathbb{D} .

One advantage of the Poincaré disc model over the upper half-plane model is that the unit disc \mathbb{D} is a bounded subset of the Euclidean plane. Thus we can view *all* of the hyperbolic plane easily on a sheet of paper (we shall see some pictures of this in the next lecture). One advantage of the upper half-plane model over the Poincaré disc model is the ease with which Cartesian co-ordinates may be used in calculations.

The geodesics in the Poincaré disc model of hyperbolic geometry are the arcs of circles and diameters in \mathbb{D} that meet $\partial\mathbb{D}$ orthogonally. We could define a distance function and develop an analysis analogous to that of the upper half-plane \mathbb{H} in lectures 2–5, but it is quicker and more convenient to transfer the results from the upper half-plane \mathbb{H} directly to this new setting.

To do this, consider the map

$$h(z) = \frac{z - i}{iz - 1}. \quad (6.1.1)$$

(Note that h is not a Möbius transformation of \mathbb{H} ; it does not satisfy the condition that $ad - bc > 0$.) It is easy to check that h maps the upper half-plane \mathbb{H} bijectively to the Poincaré disc. Moreover, h maps $\partial\mathbb{H}$ to $\partial\mathbb{D}$ bijectively.

§6.2 Distances in the Poincaré disc

We give a formula for the distance between two points in the Poincaré model of the hyperbolic plane. We do this (as we did in the upper half-plane) by first defining the length of a (piecewise continuously differentiable) path, and then defining the distance between two points to be the infimum of the lengths of all such paths joining them.

Let $g(z) = h^{-1}(z)$. Then g maps \mathbb{D} to \mathbb{H} and has the formula

$$g(z) = \frac{-z + i}{-iz + 1}.$$

Let $\sigma : [a, b] \rightarrow \mathbb{D}$ be a path in \mathbb{D} (strictly, this is a parametrisation of a path). Then $g \circ \sigma : [a, b] \rightarrow \mathbb{H}$ is a path in \mathbb{H} . The length of $g \circ \sigma$ is given by:

$$\text{length}_{\mathbb{H}}(g \circ \sigma) = \int_a^b \frac{|(g \circ \sigma)'(t)|}{\text{Im}(g \circ \sigma(t))} dt = \int_a^b \frac{|g'(\sigma(t))||\sigma'(t)|}{\text{Im}(g \circ \sigma(t))} dt,$$

using the chain rule. It is easy to calculate that

$$g'(z) = \frac{-2}{(-iz + 1)^2}$$

and

$$\operatorname{Im}(g(z)) = \frac{1 - |z|^2}{|-iz + 1|^2}.$$

Hence

$$\operatorname{length}_{\mathbb{H}}(g \circ \sigma) = \int_a^b \frac{2}{1 - |\sigma(t)|^2} |\sigma'(t)| dt. \quad (6.2.1)$$

We define the length of the path σ in \mathbb{D} by (6.2.1):

$$\operatorname{length}_{\mathbb{D}}(\sigma) = \int_a^b \frac{2}{1 - |\sigma(t)|^2} |\sigma'(t)| dt.$$

In the upper half-plane, we integrate $1/\operatorname{Im}(z)$ along a path to obtain its length; in the Poincaré disc, we integrate $2/(1 - |z|^2)$ instead.

The distance between two points $z, z' \in \mathbb{D}$ is then defined by taking the length of the shortest path between them:

$$d_{\mathbb{D}}(z, z') = \inf\{\operatorname{length}_{\mathbb{D}}(\sigma) \mid \sigma \text{ is a piecewise continuously differentiable path from } z \text{ to } z'\}.$$

As we have used h to transfer the distance function on \mathbb{H} to a distance function on \mathbb{D} we have that

$$d_{\mathbb{D}}(h(z), h(w)) = d_{\mathbb{H}}(z, w), \quad (6.2.2)$$

where $d_{\mathbb{H}}$ denotes the distance in the upper half-plane model \mathbb{H} .

Proposition 6.2.1

Let $x \in [0, 1)$. Then

$$d_{\mathbb{D}}(0, x) = \log \left(\frac{1+x}{1-x} \right).$$

Moreover, the real axis is the unique geodesic joining 0 to x .

Exercise 6.1

Check some of the assertions above, for example:

- (i) Show that h maps \mathbb{H} to \mathbb{D} bijectively. Show that h maps $\partial\mathbb{H}$ to $\partial\mathbb{D}$ bijectively.
- (ii) Calculate¹ $g(z) = h^{-1}(z)$ and show that

$$g'(z) = \frac{-2}{(-iz + 1)^2}, \quad \operatorname{Im}(g(z)) = \frac{1 - |z|^2}{|-iz + 1|^2}.$$

- (iii) Mimic the proof of Proposition 4.2.1 to show that the real axis is the unique geodesic joining 0 to $x \in (0, 1)$ and that

$$d_{\mathbb{D}}(0, x) = \log \left(\frac{1+x}{1-x} \right).$$

¹If you carefully compare the formulæ for g and for h then you might notice a similarity! However, remember that they are different functions: g maps \mathbb{D} to \mathbb{H} whereas h maps \mathbb{H} to \mathbb{D} .

§6.3 Möbius transformations of the Poincaré disc

Let $\gamma \in \text{Möb}(\mathbb{H})$. Then we obtain an isometry of the Poincaré disc \mathbb{D} by using the map h to transform γ into a map of \mathbb{D} . To see this, consider the map $h\gamma h^{-1}$. Then for any $u, v \in \mathbb{D}$

$$\begin{aligned} d_{\mathbb{D}}(h\gamma h^{-1}(u), h\gamma h^{-1}(v)) &= d_{\mathbb{H}}(\gamma h^{-1}(u), \gamma h^{-1}(v)) \\ &= d_{\mathbb{H}}(h^{-1}(u), h^{-1}(v)) \\ &= d_{\mathbb{D}}(u, v). \end{aligned}$$

Hence $h\gamma h^{-1}$ is an isometry of \mathbb{D} .

Exercise 6.2

Show that $z \mapsto h\gamma h^{-1}(z)$ is a map of the form

$$z \mapsto \frac{\alpha z + \beta}{\beta z + \bar{\alpha}}, \quad \alpha, \beta \in \mathbb{C}, \quad |\alpha|^2 - |\beta|^2 > 0.$$

Definition. We call a map of the form

$$\frac{\alpha z + \beta}{\beta z + \bar{\alpha}}, \quad \alpha, \beta \in \mathbb{C}, \quad |\alpha|^2 - |\beta|^2 > 0.$$

a *Möbius transformation of \mathbb{D}* . The set of all Möbius transformations of \mathbb{D} forms a group, which we denote by $\text{Möb}(\mathbb{D})$.

Exercise 6.3

Check directly that $\text{Möb}(\mathbb{D})$ is a group under composition.

Examples of Möbius transformations of \mathbb{D} include the rotations. Take $\alpha = e^{i\theta/2}, \beta = 0$. Then $|\alpha|^2 - |\beta|^2 = 1 > 0$ so that $\gamma(z) = e^{i\theta/2}z/e^{-i\theta/2} = e^{i\theta}z$ is a Möbius transformation of \mathbb{D} . Observe that this map is a rotation of the unit circle in \mathbb{C} .

§6.4 Geodesics in the Poincaré disc

The geodesics in the Poincaré disc are the images under h of the geodesics in the upper half-plane \mathbb{H} .

Proposition 6.4.1

The geodesics in the Poincaré disc are the diameters of \mathbb{D} and the arcs of circles in \mathbb{D} that meet $\partial\mathbb{D}$ at right-angles.

Proof (sketch). One can show that h is conformal, i.e. h preserves angles. Using the characterisation of lines and circles in \mathbb{C} as solutions to $\alpha z\bar{z} + \beta z + \bar{\beta}\bar{z} + \gamma = 0$ one can show that h maps circles and lines in \mathbb{C} to circles and lines in \mathbb{C} . Recall that h maps $\partial\mathbb{H}$ to $\partial\mathbb{D}$. Recall that the geodesics in \mathbb{H} are the arcs of circles and lines that meet $\partial\mathbb{H}$ orthogonally. As h is conformal, the image in \mathbb{D} of a geodesic in \mathbb{H} is a circle or line that meets $\partial\mathbb{D}$ orthogonally. \square

In the upper half-plane model \mathbb{H} we often map a geodesic H to the imaginary axis and a point z_0 on that geodesic to the point i . The following is the analogue of this result in the Poincaré disc model.

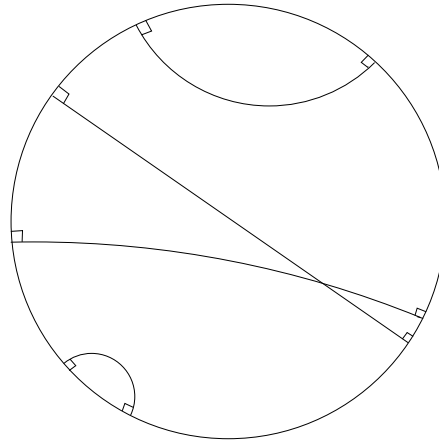

Figure 6.4.1: Some geodesics in the Poincaré disc \mathbb{D}

Proposition 6.4.2

Let H be a geodesic in \mathbb{D} and let $z_0 \in H$. Then there exists a Möbius transformation of \mathbb{D} that maps H to the real axis and z_0 to 0.

Exercise 6.4

Show that the geodesics in \mathbb{D} have equations of the form

$$\alpha z \bar{z} + \beta z + \bar{\beta} \bar{z} + \alpha = 0$$

where $\alpha \in \mathbb{R}$ and $\beta \in \mathbb{C}$.

§6.5 Area in \mathbb{D}

Recall that the area of a subset $A \subset \mathbb{H}$ is defined to be

$$\text{Area}_{\mathbb{H}}(A) = \int \int_A \frac{1}{(\text{Im } z)^2} dz.$$

We can again use h to transfer this definition to \mathbb{D} . Indeed, one can check that if $A \subset \mathbb{D}$ then

$$\text{Area}_{\mathbb{D}}(A) = \int \int_A \frac{4}{(1 - |z|^2)^2} dz.$$

Exercise 6.5

Let $C = \{w \in \mathbb{D} \mid d_{\mathbb{D}}(z_0, w) = r\}$ be a hyperbolic circle in \mathbb{D} with centre z_0 and radius $r > 0$. Calculate the circumference and area of C .

[Hints: First move C to the origin by using a Möbius transformation of \mathbb{D} . Use the formula $d_{\mathbb{D}}(0, x) = \log(1 + x)/(1 - x)$ to show that this is a Euclidean circle, but with a different radius. To calculate area, use polar co-ordinates.]

§6.6 A dictionary

	Upper half-plane	Poincaré disc
	$\mathbb{H} = \{z \in \mathbb{C} \mid \text{Im}(z) > 0\}$	$\mathbb{D} = \{z \in \mathbb{C} \mid z < 1\}$
Boundary	$\partial\mathbb{H} = \mathbb{R} \cup \{\infty\}$	$\partial\mathbb{D} = \{z \in \mathbb{C} \mid z = 1\}$
Length of a path σ	$\int_a^b \frac{1}{\text{Im} \sigma(t)} \sigma'(t) dt$	$\int_a^b \frac{2}{1 - \sigma(t) ^2} \sigma'(t) dt$
Area of a subset A	$\int \int_A \frac{1}{(\text{Im} z)^2} dz$	$\int \int_A \frac{4}{(1 - z ^2)^2} dz$
Orientation-preserving isometries	$\gamma(z) = \frac{az + b}{cz + d}$, $a, b, c, d \in \mathbb{R}$, $ad - bc > 0$	$\gamma(z) = \frac{\alpha z + \beta}{\bar{\beta}z + \bar{\alpha}}$, $\alpha, \beta \in \mathbb{C}$, $ \alpha ^2 - \beta ^2 > 0$
Geodesics	vertical half-lines and semi-circles orthogonal to $\partial\mathbb{H}$	diameters of \mathbb{D} and arcs of circles that meet $\partial\mathbb{D}$ orthogonally
Angles	Same as Euclidean angles	Same as Euclidean angles

7. The Gauss-Bonnet Theorem

§7.1 Hyperbolic polygons

In Euclidean geometry, an n -sided polygon is a subset of the Euclidean plane bounded by n straight lines. Thus the edges of a Euclidean polygon are formed by segments of Euclidean geodesics. A hyperbolic polygon is defined in an analogous manner.

Definition. Let $z, w \in \mathbb{H} \cup \partial\mathbb{H}$. Then there exists a unique geodesic that passes through both z and w . We denote by $[z, w]$ the part of this geodesic that connects z and w . We call $[z, w]$ the *segment* or *arc* of geodesic between z and w .

Definition. Let $z_1, \dots, z_n \in \mathbb{H} \cup \partial\mathbb{H}$. Then the *hyperbolic n -gon* P with vertices at z_1, \dots, z_n is the region of \mathbb{H} bounded by the geodesic segments

$$[z_1, z_2], \dots, [z_{n-1}, z_n], [z_n, z_1].$$

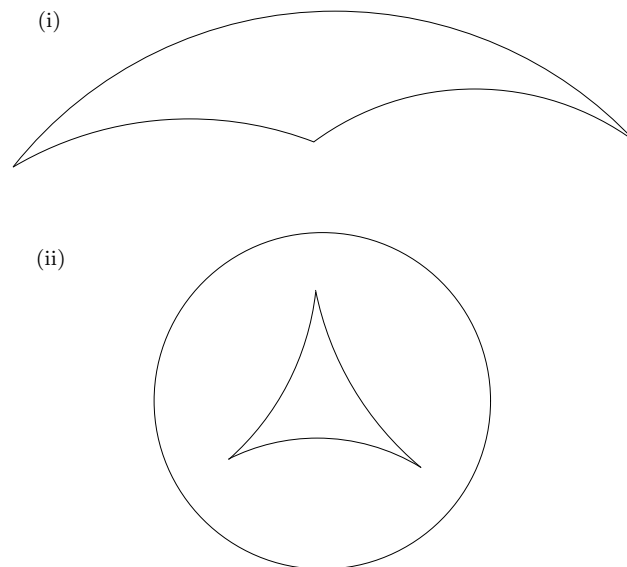

Figure 7.1.1: A hyperbolic triangle (i) in the upper half-plane model, (ii) in the Poincaré disc

Remark. Notice that we allow some of the vertices to lie on the circle at infinity. Such a vertex is called an *ideal vertex*. If all the vertices lie on $\partial\mathbb{H}$ then we call P an *ideal polygon*. Notice that the angle at an ideal vertex is zero; this is because all geodesics meet $\partial\mathbb{H}$ at right-angles and so the angle between any two such geodesics is zero.

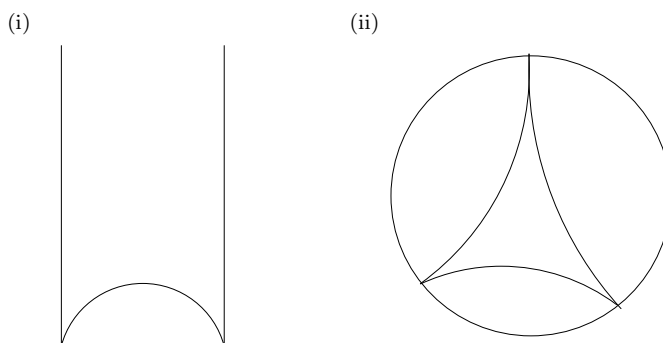

Figure 7.1.2: An ideal triangle (i) in the upper half-plane model, (ii) in the Poincaré disc

§7.2 The Gauss-Bonnet Theorem for a triangle

The Gauss-Bonnet Theorem can be stated in a wide range of contexts. In hyperbolic geometry, the Gauss-Bonnet Theorem gives a formula for the area of a hyperbolic polygon in terms of its angles—a result that has no analogue in Euclidean geometry. We will use the Gauss-Bonnet Theorem to study tessellations of the hyperbolic plane by regular polygons, and we will see that there are infinitely many distinct tessellations using regular polygons (whereas in Euclidean geometry there are only finitely many: equilateral triangles, squares, and regular hexagons).

Theorem 7.2.1 (Gauss-Bonnet Theorem for a hyperbolic triangle)

Let Δ be a hyperbolic triangle with internal angles α, β and γ . Then

$$\text{Area}_{\mathbb{H}}(\Delta) = \pi - (\alpha + \beta + \gamma). \quad (7.2.1)$$

Remarks.

1. In Euclidean geometry it is well-known that the sum of the internal angles of a Euclidean triangle is equal to π (indeed, this is equivalent to the parallel postulate). In hyperbolic geometry, (7.2.1) implies that the sum of the internal angles of a hyperbolic triangle is strictly less than π .
2. The equation (7.2.1) implies that the area of a hyperbolic triangle is at most π . The only way that the area of a hyperbolic triangle can be equal to π is if all the internal angles are equal to zero. This means that all of the vertices of the triangle lie on the circle at infinity.
3. In Euclidean geometry, the angles of a triangle do not determine the triangle's area (this is clear: scaling a triangle changes its area but not its angles). This is not the case in hyperbolic geometry.
4. There is an interactive java applet illustrating the Gauss-Bonnet Theorem at <http://www.geom.umn.edu/java/triangle-area/>.

Proof. Let Δ be a hyperbolic triangle with internal angles α, β and γ .

We first study the case when at least one of the vertices of Δ belongs to $\partial\mathbb{H}$, and hence the angle at this vertex is zero. By applying a Möbius transformation of \mathbb{H} , we can map this

vertex to ∞ without altering the area or the angles. By applying the Möbius transformation $z \mapsto z + b$ for a suitable b we can assume that the circle joining the other two vertices is centred at the origin in \mathbb{C} . By applying the Möbius transformation $z \mapsto kz$ we can assume it has radius 1. Hence (see Figure 7.2.3)

$$\begin{aligned}
 \text{Area}_{\mathbb{H}}(\Delta) &= \int \int_{\Delta} \frac{1}{y^2} dx dy \\
 &= \int_a^b \left(\int_{\sqrt{1-x^2}}^{\infty} \frac{1}{y^2} dy \right) dx \\
 &= \int_a^b \left(\frac{-1}{y} \Big|_{\sqrt{1-x^2}}^{\infty} \right) dx \\
 &= \int_a^b \frac{1}{\sqrt{1-x^2}} dx \\
 &= \int_{\pi-\alpha}^{\beta} -1 d\theta \text{ substituting } x = \cos \theta \\
 &= \pi - (\alpha + \beta).
 \end{aligned}$$

This proves (7.2.1) when one of the vertices of Δ lies on $\partial\mathbb{H}$.

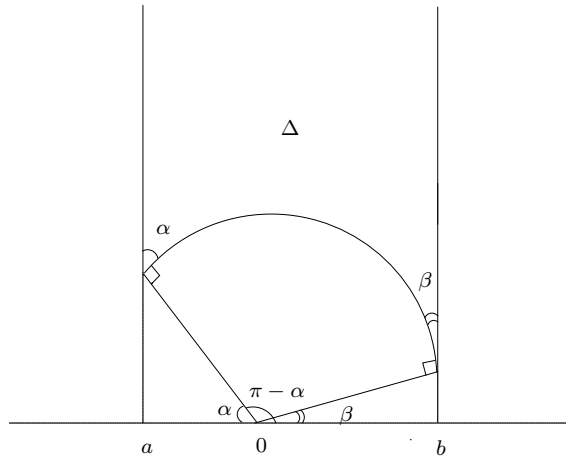

Figure 7.2.3: The Gauss-Bonnet Theorem with one vertex of Δ at ∞

Now suppose that Δ has no vertices in $\partial\mathbb{H}$. Let the vertices of Δ be A, B and C , with internal angles α, β and γ , respectively. Apply a Möbius transformation of \mathbb{H} so that the side of Δ between vertices A and C lies on a vertical geodesic. Let δ be the angle at B between the side CB and the vertical. This allows us to construct two triangles, each with one vertex at ∞ : triangle $AB\infty$ and triangle $CB\infty$. See Figure 7.2.4.

$$\text{Area}_{\mathbb{H}}(\Delta) = \text{Area}_{\mathbb{H}}(ABC) = \text{Area}_{\mathbb{H}}(AB\infty) - \text{Area}_{\mathbb{H}}(BC\infty).$$

Now

$$\begin{aligned}
 \text{Area}_{\mathbb{H}}(AB\infty) &= \pi - (\alpha + (\beta + \delta)) \\
 \text{Area}_{\mathbb{H}}(BC\infty) &= \pi - ((\pi - \gamma) + \delta).
 \end{aligned}$$

Hence

$$\begin{aligned} \text{Area}_{\mathbb{H}}(ABC) &= \pi - (\alpha + (\beta + \delta)) - (\pi - ((\pi - \gamma) + \delta)) \\ &= \pi - (\alpha + \beta + \gamma). \end{aligned}$$

□

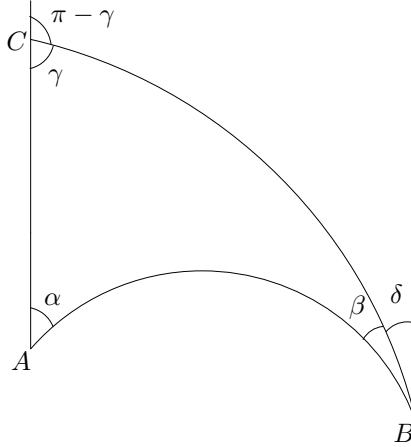

Figure 7.2.4: The Gauss-Bonnet Theorem for the triangle ABC with no vertices on $\partial\mathbb{H}$

Exercise 7.1

Consider the hyperbolic triangle in \mathbb{H} with vertices at 0 , $(-1 + i\sqrt{3})/2$, $(1 + i\sqrt{3})/2$ as illustrated in Figure 7.2.5.

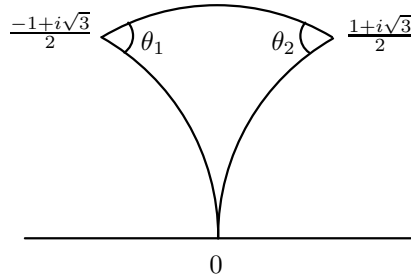

Figure 7.2.5: A hyperbolic triangle with vertices at 0 , $(-1 + i\sqrt{3})/2$, $(1 + i\sqrt{3})/2$

- (i) Determine the geodesics that comprise the sides of this triangle.
- (ii) Use Exercise 5.6 to calculate the internal angles of this triangle. Hence use the Gauss-Bonnet Theorem to calculate the hyperbolic area of this triangle.

We can generalise the above theorem to give a formula for the area of an n -sided polygon.

Theorem 7.2.2 (Gauss-Bonnet Theorem for a hyperbolic polygon)

Let P be an n -sided hyperbolic polygon with vertices v_1, \dots, v_n and internal angles $\alpha_1, \dots, \alpha_n$. Then

$$\text{Area}_{\mathbb{H}}(P) = (n - 2)\pi - (\alpha_1 + \dots + \alpha_n). \tag{7.2.2}$$

Proof (sketch). Cut up P into triangles. Apply Theorem 7.2.1 to each triangle and then sum the areas. \square

Exercise 7.2

Assuming Theorem 7.2.1 but not Theorem 7.2.2, prove that the area of a hyperbolic quadrilateral with internal angles $\alpha_1, \alpha_2, \alpha_3, \alpha_4$ is given by

$$2\pi - (\alpha_1 + \alpha_2 + \alpha_3 + \alpha_4).$$

§7.3 Tessellations of the hyperbolic plane by regular polygons

Recall that a regular n -gon is an n -gon where all n sides have the same length and all internal angles are equal. We are interested in the following problem: when can we tile the plane using regular n -gons with k polygons meeting at each vertex?

In Lecture 1 we remarked that the only possible tessellations of \mathbb{R}^2 are given by: equilateral triangles (with 6 triangles meeting at each vertex), squares (with 4 squares meeting at each vertex), and by regular hexagons (with 3 hexagons meeting at each vertex).

In hyperbolic geometry, the situation is far more interesting: there are infinitely many different tessellations by regular polygons!

Theorem 7.3.1

There exists a tessellation of the hyperbolic plane by regular hyperbolic n -gons with k polygons meeting at each vertex if and only if

$$\frac{1}{n} + \frac{1}{k} < \frac{1}{2}. \quad (7.3.1)$$

Proof. We only prove that if there is a tessellation then n, k satisfy (7.3.1), the converse is harder. Let α denote the internal angle of a regular n -gon P . Then as k such polygons meet at each vertex, we must have that $\alpha = 2\pi/k$. As the area of the polygon P must be positive, substituting $\alpha = 2\pi/k$ into (7.2.2) and re-arranging we have:

$$\frac{1}{n} + \frac{1}{k} < \frac{1}{2},$$

as required. \square

Figures 7.3.6, 7.3.7 and 7.3.8 illustrate some tilings of the hyperbolic plane. In Figure 7.3.6, the Poincaré disc is tiled by regular hyperbolic octagons, with 4 octagons meeting at each vertex. In Figure 7.3.7, the Poincaré disc is tiled by regular hyperbolic pentagons, with 4 pentagons meeting at each vertex. In Figure 7.3.8, the Poincaré disc is tiled by regular hyperbolic quadrilaterals (hyperbolic squares), with 8 quadrilaterals meeting at each vertex. All of the hyperbolic octagons (respectively pentagons, quadrilaterals) in Figure 7.3.6 (respectively Figure 7.3.7, Figure 7.3.8) have the same hyperbolic area and the sides all have the same hyperbolic length. They look as if they are getting smaller as they approach the boundary of the hyperbolic plane because we are trying to represent all of the hyperbolic plane in the Euclidean plane, and necessarily some distortion must occur. You are already familiar with this: when one tries to represent the surface of the Earth on a sheet of (Euclidean!) paper, some distortion occurs as one tries to flatten out the sphere; in Figure 7.3.9, Greenland appears unnaturally large compared to Africa when the surface of the Earth is projected onto the plane.

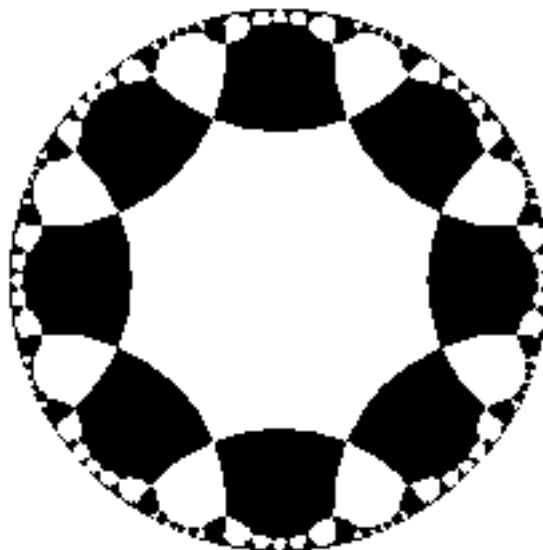

Figure 7.3.6: A tessellation of the Poincaré disc with $n = 8$, $k = 4$

Remark. Here is a tiling of the hyperbolic plane that you can scroll around in:
<https://www.math.univ-toulouse.fr/~cheritat/AppletsDivers/Escher/index>.

You can make your own tilings of the hyperbolic plane here:
<http://www.malinc.se/m/ImageTiling.php>.

Remark. The game ‘Bejeweled’ (playable online for free here:
<http://www.popcap.com/games/bejeweled2/online>) works in Euclidean space. The plane is tiled by (Euclidean) squares (with, necessarily, 4 squares meeting at each vertex). The aim of the game is to swap neighbouring pairs of squares so that three or more tiles of the same colour lie along a geodesic; these tiles then disappear. One could set up the same game in hyperbolic space: given a hyperbolic tiling, swap neighbouring tiles so that three or more tiles lie along a common geodesic which, again, then disappear. This is implemented in the game ‘Circull’, this was available for iOS here but no longer seems to be available:
<http://itunes.apple.com/gb/app/circull/id392042223?mt=8>.

Other online games that take place in hyperbolic geometry include ‘Hyperbolic Maze’:
<http://www.madore.org/~david/math/hyperbolic-maze.html> and ‘Hyperrogue’
<http://www.roguetemple.com/z/hyper>.

One technical point that we have glossed over is the existence of regular n -gons in hyperbolic geometry. To see that such polygons exist we quote the following result.

Proposition 7.3.2

Let $\alpha_1, \dots, \alpha_n$ be such that

$$(n - 2)\pi - \sum_{k=1}^n \alpha_k > 0.$$

Then there exists a polygon with internal angles α_k .

Proof. See Beardon Theorem 7.16.2. □

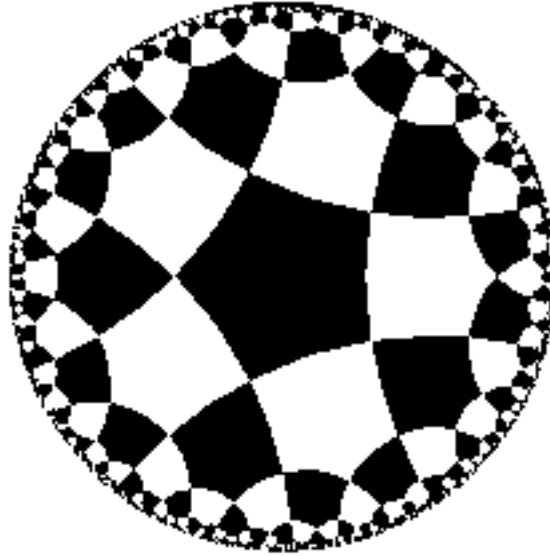

Figure 7.3.7: A tessellation of the Poincaré disc with $n = 5$, $k = 4$

Remark. One can show that if the internal angles of a hyperbolic polygon are all equal then the lengths of the sides are all equal. (This is not true in Euclidean geometry: a rectangle has right-angles for all of its internal angles, but the sides are not all of the same length.)

Exercise 7.3

Let $n \geq 3$. By explicit construction, show that there exists a regular n -gon with internal angle equal to α if and only if $\alpha \in [0, (n-2)\pi/n)$.

(Hint: Work in the Poincaré disc \mathbb{D} . Let $\omega = e^{2\pi i/n}$ be an n^{th} root of unity. Fix $r \in (0, 1)$ and consider the polygon $D(r)$ with vertices at $r, r\omega, r\omega^2, \dots, r\omega^{n-1}$. This is a regular n -gon (why?). Let $\alpha(r)$ denote the internal angle of $D(r)$. Use the Gauss-Bonnet Theorem to express the area of $D(r)$ in terms of $\alpha(r)$. Examine what happens as $r \rightarrow 0$ and as $r \rightarrow 1$. (To examine $\lim_{r \rightarrow 0} \text{Area}_{\mathbb{H}} D(r)$, note that $D(r)$ is contained in a hyperbolic circle $C(r)$, and use Exercise 6.5 to calculate $\lim_{r \rightarrow 0} \text{Area}_{\mathbb{H}} C(r)$.) You may use without proof the fact that $\alpha(r)$ depends continuously on r .)

In particular, conclude that there there exists a regular n -gon with each internal angle equal to a right-angle whenever $n \geq 5$. This is in contrast with the Euclidean case where, of course, the only regular polygon with each internal angle equal to a right-angle is the square.

Exercise 7.4

(This exercise is outside the scope of the course (and therefore not examinable). However, anybody remotely interested in pure mathematics should get to see what is below at least once.)

A *polyhedron* in \mathbb{R}^3 is formed by joining together polygons along their edges. A *platonic solid* is a convex polyhedra where each constituent polygon is a regular n -gon, with k polygons meeting at each vertex.

By mimicking the discussions above, show that there are precisely five platonic solids:

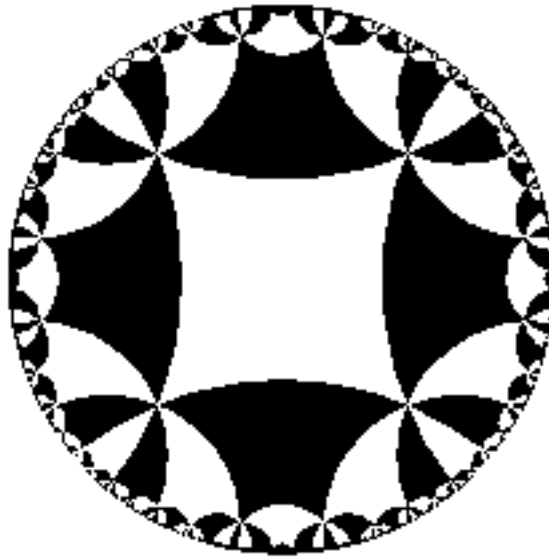

Figure 7.3.8: A tessellation of the Poincaré disc with $n = 4$, $k = 8$

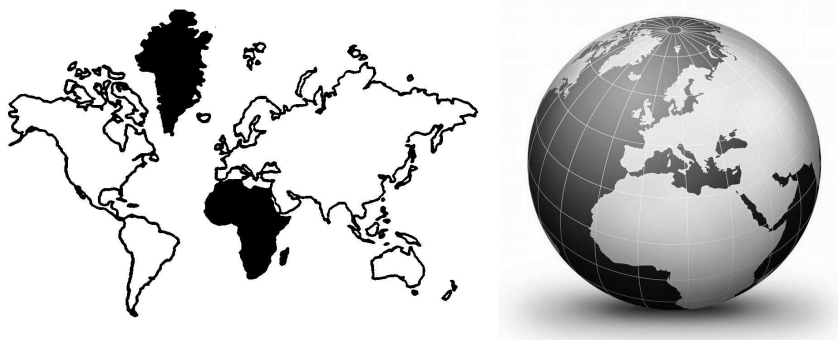

Figure 7.3.9: When projected onto a (Euclidean) plane, the surface of the Earth is distorted

the tetrahedron, cube, octahedron, dodecahedron and icosahedron (corresponding to $(n, k) = (3, 3), (4, 3), (3, 4), (5, 3)$ and $(3, 5)$, respectively).

8. Hyperbolic triangles

§8.1 Right-angled triangles

In Euclidean geometry there are many well-known relationships between the sides and the angles of a right-angled triangle. For example, Pythagoras' Theorem gives a relationship between the three sides. Here we study the corresponding results in hyperbolic geometry. Throughout this section, Δ will be a right-angled triangle. The internal angles will be $\alpha, \beta, \pi/2$, with the opposite sides having lengths a, b, c .

§8.2 Two sides, one angle

For a right-angled triangle in Euclidean geometry there are well-known relationships between an angle and any of two of the sides, namely 'sine = opposite / hypotenuse', 'cosine = adjacent / hypotenuse' and 'tangent = opposite / adjacent'. Here we determine similar relationships in the case of a hyperbolic right-angled triangle.

Proposition 8.2.1

Let Δ be a right-angled triangle in \mathbb{H} with internal angles $\alpha, \beta, \pi/2$ and opposing sides with lengths a, b, c . Then

$$(i) \sin \alpha = \sinh a / \sinh c,$$

$$(ii) \cos \alpha = \tanh b / \tanh c,$$

$$(iii) \tan \alpha = \tanh a / \sinh b.$$

Proof. As in the proof of Theorem 5.7.1, we can apply a Möbius transformation of \mathbb{H} to Δ and assume without loss in generality that the vertices of Δ are at i, ki and $s + it$, where $s + it$ lies in the unit circle centred at the origin and the right-angle occurs at i .

The vertices at ki and $s + it$ lie on a unique geodesic. This geodesic is a semi-circle with centre $x \in \mathbb{R}$. The (Euclidean) straight line from x to ki is inclined at angle α from the real axis. See Figure 8.2.1. The line from x to ki is a radius of this semi-circle, as is the line from x to $s + it$. Calculating the lengths of these radii, we see that

$$k^2 + x^2 = (s + x)^2 + t^2$$

so that

$$k^2 = 1 + 2sx, \tag{8.2.1}$$

using the fact that $s^2 + t^2 = 1$.

By considering the Euclidean triangle with vertices at $x, ki, 0$, we see that

$$\tan \alpha = \frac{k}{x} = \frac{2ks}{k^2 - 1}, \tag{8.2.2}$$

where we have substituted for x from (8.2.1).

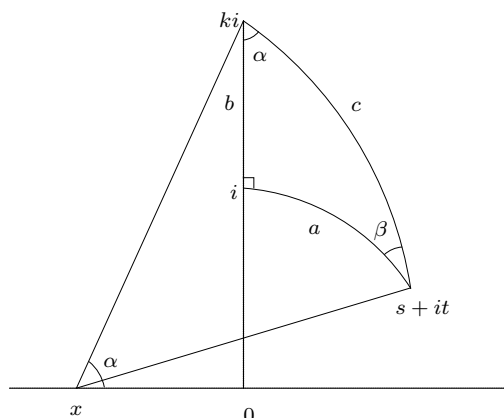

Figure 8.2.1: The point x is the centre of the semi-circle corresponding to the geodesic through ki and $s + it$

Using the facts that $\cosh^2 - \sinh^2 = 1$ and $\tanh = \sinh / \cosh$ it follows from (5.7.2) and (5.7.3) that

$$\sinh b = \frac{k^2 - 1}{2k}, \quad \tanh a = s.$$

Combining this with (8.2.2) we see that

$$\tan \alpha = \frac{\tanh a}{\sinh b},$$

proving statement (iii) of the proposition.

The other two statements follow by using trig identities, relationships between \sinh and \cosh , and the hyperbolic version of Pythagoras' Theorem. \square

Exercise 8.1

Assuming that $\tan \alpha = \tanh a / \sinh b$, prove that $\sin \alpha = \sinh a / \sinh c$ and $\cos \alpha = \tanh b / \tanh c$.

Exercise 8.2

We now have relationships involving: (i) three angles (the Gauss-Bonnet Theorem), (ii) three sides (Pythagoras' Theorem) and (iii) two sides, one angle. Prove the following relationships between one side and two angles:

$$\cosh a = \cos \alpha \operatorname{cosec} \beta, \quad \cosh c = \cot \alpha \cot \beta.$$

What are the Euclidean analogues of these identities?

§8.3 The angle of parallelism

Consider the special case of a right-angled triangle with one ideal vertex. (Recall that a vertex is said to be *ideal* if it lies on the boundary.) In this case, the internal angles of the triangle are $\alpha, 0$ and $\pi/2$ and the only side with finite length is that between the vertices with internal angles α and $\pi/2$. The angle of parallelism is a classical term for this angle expressed in terms of the side of finite length.

Proposition 8.3.1

Let Δ be a hyperbolic triangle with angles α , 0 and $\pi/2$. Let a denote the length of the only finite side. Then

$$(i) \quad \sin \alpha = \frac{1}{\cosh a};$$

$$(ii) \quad \cos \alpha = \frac{1}{\coth a};$$

$$(iii) \quad \tan \alpha = \frac{1}{\sinh a}.$$

Proof. The three formulæ for α are easily seen to be equivalent. Therefore we need only prove that (i) holds.

After applying a Möbius transformation of \mathbb{H} , we can assume that the ideal vertex of Δ is at ∞ and that the vertex with internal angle $\pi/2$ is at i . The third vertex is then easily seen to be at $\cos \alpha + i \sin \alpha$. See Figure 8.3.2.

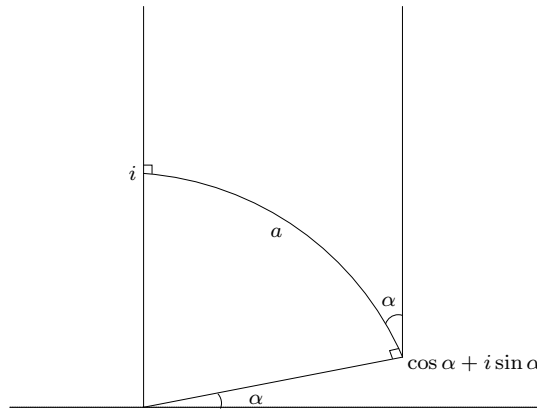

Figure 8.3.2: The angle of parallelism

Recall that

$$\cosh d_{\mathbb{H}}(z, w) = 1 + \frac{|z - w|^2}{2 \operatorname{Im}(z) \operatorname{Im}(w)}.$$

Applying this formula with $z = i$ and $w = \cos \alpha + i \sin \alpha$ we see that

$$\cosh a = \cosh d_{\mathbb{H}}(z, w) = 1 + \frac{2(1 - \sin \alpha)}{2 \sin \alpha} = \frac{1}{\sin \alpha}.$$

□

Exercise 8.3

Assuming that $\sin \alpha = 1/\cosh a$, check using standard trig and hyperbolic trig identities that $\cos \alpha = 1/\coth a$ and $\tan \alpha = 1/\sinh a$.

§8.4 Non-right-angled triangles: the sine rule

Recall that in Euclidean geometry the sine rule takes the following form. In a triangle (not necessarily right-angled) with internal angles α, β and γ and side lengths a, b and c we have

$$\frac{\sin \alpha}{a} = \frac{\sin \beta}{b} = \frac{\sin \gamma}{c}.$$

The hyperbolic version of this is the following.

Proposition 8.4.1

Let Δ be a hyperbolic triangle with internal angles α, β and γ and side lengths a, b, c . Then

$$\frac{\sin \alpha}{\sinh a} = \frac{\sin \beta}{\sinh b} = \frac{\sin \gamma}{\sinh c}.$$

Exercise 8.4

Prove Proposition 8.4.1 in the case when Δ is acute (the obtuse case is a simple modification of the argument, and is left for anybody interested...).

(Hint: label the vertices A, B, C with angle α at vertex A , etc. Drop a perpendicular from vertex B meeting the side $[A, C]$ at, say, D to obtain two right-angled triangles ABD, BCD . Use Pythagoras' Theorem and Proposition 8.2.1 in both of these triangles to obtain an expression for $\sin \alpha$.)

§8.5 Non-right-angled triangles: cosine rules**§8.5.1 The cosine rule I**

Recall that in Euclidean geometry we have the following cosine rule. Consider a triangle (not necessarily right-angled) with internal angles α, β and γ and sides of lengths a, b and c , with side a opposite angle α , etc. Then

$$c^2 = a^2 + b^2 - 2ab \cos \gamma.$$

The corresponding hyperbolic result is.

Proposition 8.5.1

Let Δ be a hyperbolic triangle with internal angles α, β and γ and side lengths a, b, c . Then

$$\cosh c = \cosh a \cosh b - \sinh a \sinh b \cos \gamma.$$

Proof. See Anderson's book. □

§8.5.2 The cosine rule II

The second cosine rule is the following.

Proposition 8.5.2

Let Δ be a hyperbolic triangle with internal angles α, β and γ and side lengths a, b, c . Then

$$\cosh c = \frac{\cos \alpha \cos \beta + \cos \gamma}{\sin \alpha \sin \beta}.$$

Proof. See Anderson's book. □

Remark. The second cosine rule has no analogue in Euclidean geometry. Observe that the second cosine rule implies the following: if we know the internal angles α, β, γ of a hyperbolic triangle, then we can calculate the lengths of its sides. In Euclidean geometry, the angles of a triangle do not determine the lengths of the sides.

9. Fixed points of Möbius transformations

§9.1 Where we are going

Recall that a transformation $\gamma : \mathbb{H} \rightarrow \mathbb{H}$ of the form

$$\gamma(z) = \frac{az + b}{cz + d}$$

where $a, b, c, d \in \mathbb{R}$, $ad - bc > 0$, is called a Möbius transformation of \mathbb{H} . The aim of the next few lectures is to classify the types of behaviour that Möbius transformations exhibit. We will see that there are three different classes of Möbius transformation: parabolic, elliptic and hyperbolic.

§9.1.1 Fixed points of Möbius transformations

Let γ be a Möbius transformation of \mathbb{H} . We say that a point $z_0 \in \mathbb{H} \cup \partial\mathbb{H}$ is a *fixed point* of γ if

$$\gamma(z_0) = \frac{az_0 + b}{cz_0 + d} = z_0. \quad (9.1.1)$$

Our initial classification of Möbius transformations is based on how many fixed points a given Möbius transformation has, and whether they lie in \mathbb{H} or on the circle at infinity $\partial\mathbb{H}$.

Clearly the identity map is a Möbius transformation which fixes every point. Throughout this section, we will assume that γ is not the identity.

Let us first consider the case when $\infty \in \partial\mathbb{H}$ is a fixed point. Recall that we calculate $\gamma(\infty)$ by writing

$$\gamma(z) = \frac{a + b/z}{c + d/z}$$

and noting that as $z \rightarrow \infty$ we have $1/z \rightarrow 0$. Hence $\gamma(\infty) = a/c$. Thus ∞ is a fixed point of γ if and only if $\gamma(\infty) = \infty$, and this happens if and only if $c = 0$.

Suppose that ∞ is a fixed point of γ so that $c = 0$. What other fixed points can γ have? Observe that now

$$\gamma(z_0) = \frac{a}{d}z_0 + \frac{b}{d}.$$

Hence γ also has a fixed point at $z_0 = b/(d - a)$. (Note that if $a = d$ then this point may be ∞ .)

Thus if $\infty \in \partial\mathbb{H}$ is a fixed point for γ then γ has at most one other fixed point, and this fixed point also lies on $\partial\mathbb{H}$.

Now let us consider the case when ∞ is not a fixed point of γ . In this case, $c \neq 0$. Multiplying (9.1.1) by $cz_0 + d$ (which is non-zero as $z_0 \neq -d/c$) we see that z_0 is a fixed point if and only if

$$cz_0^2 + (d - a)z_0 - b = 0. \quad (9.1.2)$$

This is a quadratic in z_0 with real coefficients. Hence there are either (i) one or two real solutions, or (ii) two complex conjugate solutions to (9.1.2). In the latter case, only one solution lies in $\mathbb{H} \cup \partial\mathbb{H}$.

Thus we have proved:

Proposition 9.1.1

Let γ be a Möbius transformation of \mathbb{H} and suppose that γ is not the identity. Then γ has either:

- (i) two fixed points in $\partial\mathbb{H}$ and none in \mathbb{H} ;
- (ii) one fixed point in $\partial\mathbb{H}$ and none in \mathbb{H} ;
- (iii) no fixed points in $\partial\mathbb{H}$ and one in \mathbb{H} .

Corollary 9.1.2

Suppose γ is a Möbius transformation of \mathbb{H} with three or more fixed points. Then γ is the identity (and so fixes every point).

Definition. Let γ be a Möbius transformation of \mathbb{H} . We will say that

- (i) γ is *hyperbolic* if it has two fixed points in $\partial\mathbb{H}$ and none in \mathbb{H} ,
- (ii) γ is *parabolic* if it has one fixed point in $\partial\mathbb{H}$ and none in \mathbb{H} ,
- (iii) γ is *elliptic* if it has one fixed point in \mathbb{H} and none in $\partial\mathbb{H}$.

Exercise 9.1

Find the fixed points in $\mathbb{H} \cup \partial\mathbb{H}$ of the following Möbius transformations of \mathbb{H} :

$$\gamma_1(z) = \frac{2z + 5}{-3z - 1}, \quad \gamma_2(z) = 7z + 6, \quad \gamma_3(z) = -\frac{1}{z}, \quad \gamma_4(z) = \frac{z}{z + 1}.$$

In each case, state whether the map is parabolic, elliptic or hyperbolic.

§9.2 A matrix representation

Let γ_1 and γ_2 be the Möbius transformations of \mathbb{H} given by

$$\gamma_1(z) = \frac{a_1z + b_1}{c_1z + d_1}, \quad \gamma_2(z) = \frac{a_2z + b_2}{c_2z + d_2}.$$

Then the composition $\gamma_2 \circ \gamma_1$ is a Möbius transformation of \mathbb{H} of the form

$$\begin{aligned} \gamma_2\gamma_1(z) &= \frac{a_2 \left(\frac{a_1z + b_1}{c_1z + d_1} \right) + b_2}{c_2 \left(\frac{a_1z + b_1}{c_1z + d_1} \right) + d_2} \\ &= \frac{(a_2a_1 + b_2c_1)z + (a_2b_1 + b_2d_1)}{(c_2a_1 + d_2c_1)z + (c_2b_1 + d_2d_1)}. \end{aligned} \tag{9.2.1}$$

Observe the connection between the coefficients in (9.2.1) and the matrix product

$$\begin{pmatrix} a_2 & b_2 \\ c_2 & d_2 \end{pmatrix} \begin{pmatrix} a_1 & b_1 \\ c_1 & d_1 \end{pmatrix} = \begin{pmatrix} a_2a_1 + b_2c_1 & a_2b_1 + b_2d_1 \\ c_2a_1 + d_2c_1 & c_2b_1 + d_2d_1 \end{pmatrix}.$$

(Thus we can calculate the coefficients of the composition of two Möbius transformations γ_1, γ_2 by multiplying the 2×2 matrices of the coefficients of γ_1, γ_2 .) We now explore the connections between Möbius transformations of \mathbb{H} and matrices.

Notice that if

$$\gamma(z) = \frac{az + b}{cz + d}$$

is a Möbius transformation of \mathbb{H} , then

$$z \mapsto \frac{\lambda az + \lambda b}{\lambda cz + \lambda d}$$

gives the same Möbius transformation of \mathbb{H} (provided $\lambda \neq 0$). Thus, by taking $\lambda = 1/\sqrt{ad - bc}$ we can always assume that $ad - bc = 1$.

Definition. The Möbius transformation $\gamma(z) = (az + b)/(cz + d)$ of \mathbb{H} is said to be *in normalised form* (or *normalised*) if $ad - bc = 1$.

Exercise 9.2

Normalise the Möbius transformations of \mathbb{H} given in Exercise 9.1.

We now introduce the following group of matrices.

Definition. The set of matrices

$$\mathrm{SL}(2, \mathbb{R}) = \left\{ A = \begin{pmatrix} a & b \\ c & d \end{pmatrix} \mid a, b, c, d \in \mathbb{R}, \det A = ad - bc = 1 \right\}$$

is called the *special linear group of \mathbb{R}^2* .

Exercise 9.3

(i) Show that $\mathrm{SL}(2, \mathbb{R})$ is indeed a group (under matrix multiplication). (Recall that G is a group if: (i) if $g, h \in G$ then $gh \in G$, (ii) the identity is in G , (iii) if $g \in G$ then there exists $g^{-1} \in G$ such that $gg^{-1} = g^{-1}g = \text{identity}$.)

(ii) Define the subgroup

$$\mathrm{SL}(2, \mathbb{Z}) = \left\{ \begin{pmatrix} a & b \\ c & d \end{pmatrix} \mid a, b, c, d \in \mathbb{Z}; ad - bc = 1 \right\}$$

to be the subset of $\mathrm{SL}(2, \mathbb{R})$ where all the entries are integers. Show that $\mathrm{SL}(2, \mathbb{Z})$ is a subgroup of $\mathrm{SL}(2, \mathbb{R})$. (Recall that if G is a group and $H \subset G$ then H is a subgroup if it is itself a group.)

Hence if $A \in \mathrm{SL}(2, \mathbb{R})$ is a matrix with entries $(a, b; c, d)$ then we can associate a normalised Möbius transformation $\gamma_A \in \mathrm{Möb}(\mathbb{H})$ by defining $\gamma_A(z) = (az + b)/(cz + d)$.

However, distinct matrices in $\mathrm{SL}(2, \mathbb{R})$ can give the same Möbius transformation of \mathbb{H} . To see this, notice that the two matrices

$$\begin{pmatrix} a & b \\ c & d \end{pmatrix}, \begin{pmatrix} -a & -b \\ -c & -d \end{pmatrix}$$

where $ad - bc = 1$ are both elements of $\mathrm{SL}(2, \mathbb{R})$ but give the same Möbius transformation of \mathbb{H} . This, however, is the only way that distinct matrices in $\mathrm{SL}(2, \mathbb{R})$ can give the same Möbius transformation of \mathbb{H} .

Remark. Thus we can think of $\text{Möb}(\mathbb{H})$ as the group of matrices $\text{SL}(2, \mathbb{R})$ with two matrices A, B identified iff $A = -B$. Sometimes $\text{Möb}(\mathbb{H})$ is denoted by $\text{PSL}(2, \mathbb{R})$, the *projective special linear group*.

10. Classifying Möbius transformations: conjugacy, trace, and applications to parabolic transformations

§10.1 Conjugacy of Möbius transformations

Before we start discussing the geometry and classification of Möbius transformations, we introduce a notion of ‘sameness’ for Möbius transformations.

Definition. Let $\gamma_1, \gamma_2 \in \text{Möb}(\mathbb{H})$ be two Möbius transformations of \mathbb{H} . We say that γ_1 and γ_2 are *conjugate* if there exists another Möbius transformation $g \in \text{Möb}(\mathbb{H})$ such that $\gamma_1 = g^{-1} \circ \gamma_2 \circ g$.

Remarks.

- (i) Geometrically, if γ_1 and γ_2 are conjugate then the action of γ_1 on $\mathbb{H} \cup \partial\mathbb{H}$ is the same as the action of γ_2 on $g(\mathbb{H} \cup \partial\mathbb{H})$. Thus conjugacy reflects a change in coordinates of $\mathbb{H} \cup \partial\mathbb{H}$.
- (ii) If γ_2 has matrix $A_2 \in \text{SL}(2, \mathbb{R})$ and g has matrix $A \in \text{SL}(2, \mathbb{R})$ then γ_1 has matrix $\pm A^{-1}A_2A$.
- (iii) We can define conjugacy for Möbius transformations of \mathbb{D} in exactly the same way: two Möbius transformations $\gamma_1, \gamma_2 \in \text{Möb}(\mathbb{D})$ of \mathbb{D} are *conjugate* if there exists $g \in \text{Möb}(\mathbb{D})$ such that $\gamma_1 = g^{-1} \circ \gamma_2 \circ g$.

Exercise 10.1

- (i) Prove that conjugacy between Möbius transformations of \mathbb{H} is an equivalence relation.
- (ii) Show that if γ_1 and γ_2 are conjugate then they have the same number of fixed points. Hence show that if γ_1 is hyperbolic, parabolic or elliptic then γ_2 is hyperbolic, parabolic or elliptic, respectively.

§10.2 The trace of a Möbius transformation

Recall that if A is a matrix then the *trace* of A is defined to be the sum of the diagonal entries of A . That is, if $A = (a, b; c, d)$ then $\text{Trace}(A) = a + d$.

Let $\gamma(z) = (az + b)/(cz + d)$ be a Möbius transformation of \mathbb{H} , $ad - bc > 0$. By dividing the coefficients a, b, c, d by $\sqrt{ad - bc}$, we can always write γ in normalised form. Assume that γ is written in normalised form. Then we can associate to γ a matrix $A = (a, b; c, d)$; as $ad - bc = 1$ we see that $A \in \text{SL}(2, \mathbb{R})$. However, as we saw in Lecture 9, this matrix is not unique; instead we could have associated the matrix $-A = (-a, -b; -c, -d)$ to γ . Thus we can define a function

$$\tau(\gamma) = (\text{Trace}(A))^2 = (\text{Trace}(-A))^2.$$

Definition. Let $\gamma \in \text{Möb}(\mathbb{H})$ be a Möbius transformation of \mathbb{H} with $\gamma(z) = (az + b)/(cz + d)$ where $ad - bc = 1$. We call $\tau(\gamma) = (a + d)^2$ the *trace* of γ .

The following result says that conjugate Möbius transformations of \mathbb{H} have the same trace.

Proposition 10.2.1

Let γ_1 and γ_2 be conjugate Möbius transformations of \mathbb{H} . Then $\tau(\gamma_1) = \tau(\gamma_2)$.

Exercise 10.2

Prove the above proposition. (Hint: show that if $A_1, A_2, A \in \text{SL}(2, \mathbb{R})$ are matrices such that $A_1 = A^{-1}A_2A$ then $\text{Trace}(A_1) = \text{Trace}(A^{-1}A_2A) = \text{Trace}(A_2)$. You might first want to show that $\text{Trace}(AB) = \text{Trace}(BA)$ for any two matrices A, B .)

We can now classify the three types of Möbius transformation—hyperbolic, parabolic and elliptic—in terms of the trace function.

Let $\gamma \in \text{Möb}(\mathbb{H})$ be a Möbius transformation of \mathbb{H} . Suppose for simplicity that ∞ is not a fixed point (it follows that $c \neq 0$). Recall from Lecture 9 that z_0 is a fixed point of γ if and only if

$$z_0 = \frac{a - d \pm \sqrt{(a - d)^2 + 4bc}}{2c}.$$

Thus there are two real solutions, one real solution or one complex conjugate pair of solutions depending on whether the term inside the square-root is greater than zero, equal to zero or less than zero, respectively. Using the identities

$$ad - bc = 1, \quad (a + d)^2 = \tau(\gamma)$$

it is easy to see that

$$(a - d)^2 + 4bc = \tau(\gamma) - 4.$$

When $c = 0$, we must have that ∞ is a fixed point. The other fixed point is given by $b/(d - a)$. Hence ∞ is the only fixed point if $a = d$ (in which case we must have that $a = 1, d = 1$ or $a = -1, d = -1$ as $ad - bc = ad = 1$); hence $\tau(\gamma) = (1 + 1)^2 = 4$. If $a \neq d$ then there are two fixed points on $\partial\mathbb{H}$ and one can easily see that $\tau(\gamma) > 4$.

Thus we have proved:

Proposition 10.2.2

Let $\gamma \in \text{Möb}(\mathbb{H})$ be a Möbius transformation of \mathbb{H} and suppose that γ is not the identity. Then:

- (i) γ is parabolic if and only if $\tau(\gamma) = 4$;
- (ii) γ is elliptic if and only if $\tau(\gamma) \in [0, 4)$;
- (iii) γ is hyperbolic if and only if $\tau(\gamma) \in (4, \infty)$.

§10.3 Parabolic transformations

Recall that a Möbius transformation $\gamma \in \text{Möb}(\mathbb{H})$ is said to be *parabolic* if it has a unique fixed point and that fixed point lies on $\partial\mathbb{H}$.

For example, the Möbius transformation of \mathbb{H} given by

$$\gamma(z) = z + 1$$

is parabolic. Here, the unique fixed point is ∞ . In general, a Möbius transformation of \mathbb{H} of the form $z \mapsto z + b$ is called a *translation*.

Exercise 10.3

Let $\gamma(z) = z + b$. If $b > 0$ then show that γ is conjugate to $\gamma(z) = z + 1$. If $b < 0$ then show that γ is conjugate to $\gamma(z) = z - 1$. Are $z \mapsto z - 1, z \mapsto z + 1$ conjugate?

Proposition 10.3.1

Let γ be a Möbius transformation of \mathbb{H} and suppose that γ is not the identity. Then the following are equivalent

- (i) γ is parabolic;
- (ii) $\tau(\gamma) = 4$;
- (iii) γ is conjugate to a translation;
- (iv) γ is conjugate either to the translation $z \mapsto z + 1$ or to the translation $z \mapsto z - 1$.

Proof. By Proposition 10.2.2 we know that (i) and (ii) are equivalent. Clearly (iv) implies (iii) and the exercise above implies that (iii) implies (iv).

Suppose that (iv) holds. Recall that $z \mapsto z + 1$ has a unique fixed point at ∞ . Hence if γ is conjugate to $z \mapsto z + 1$ then γ has a unique fixed point in $\partial\mathbb{H}$, and is therefore parabolic. The same argument holds for $z \mapsto z - 1$.

Finally, we show that (i) implies (iii). Suppose that γ is parabolic and has a unique fixed point at $\zeta \in \partial\mathbb{H}$. Let g be a Möbius transformation of \mathbb{H} that maps ζ to ∞ . Then $g\gamma g^{-1}$ is a Möbius transformation with a unique fixed point at ∞ . We claim that $g\gamma g^{-1}$ is a translation. Write

$$g\gamma g^{-1}(z) = \frac{az + b}{cz + d}.$$

As ∞ is a fixed point of $g\gamma g^{-1}$, we must have that $c = 0$ (see Lecture 11). Hence

$$g\gamma g^{-1}(z) = \frac{a}{d}z + \frac{b}{d},$$

and it follows that $g\gamma g^{-1}$ has a fixed point at $b/(d - a)$. As $g\gamma g^{-1}$ has only one fixed point and the fixed point is at ∞ we must have that $d = a$. Thus $g\gamma g^{-1}(z) = z + b'$ for some $b' \in \mathbb{R}$. Hence γ is conjugate to a translation. \square

11. Classifying Möbius transformations: hyperbolic and elliptic transformations

§11.1 Introduction

In Lecture 10 we saw how to classify Möbius transformations of \mathbb{H} in terms of their trace and saw what it meant for two Möbius transformations of \mathbb{H} to be conjugate. We then studied parabolic Möbius transformations of \mathbb{H} (recall that a Möbius transformation of \mathbb{H} is said to be parabolic if it has precisely one fixed point on $\partial\mathbb{H}$). We saw that any parabolic Möbius transformation of \mathbb{H} is conjugate to a translation.

The aim of this lecture is to find similar classifications for hyperbolic Möbius transformations and for elliptic Möbius transformations.

§11.2 Hyperbolic transformations

Recall that a Möbius transformation of \mathbb{H} is said to be hyperbolic if it has exactly two fixed points on $\partial\mathbb{H}$.

For example, let $k > 0$ and suppose that $k \neq 1$. Then the Möbius transformation $\gamma(z) = kz$ of \mathbb{H} is hyperbolic. The two fixed points are 0 and ∞ . In general, a Möbius transformation of the form $z \mapsto kz$ where $k \neq 1$ is called a *dilation*.

Exercise 11.1

Show that two dilations $z \mapsto k_1z$, $z \mapsto k_2z$ are conjugate (as Möbius transformations of \mathbb{H}) if and only if $k_1 = k_2$ or $k_1 = 1/k_2$.

We can now classify hyperbolic Möbius transformations.

Proposition 11.2.1

Let $\gamma \in \text{Möb}(\mathbb{H})$ be a Möbius transformation of \mathbb{H} . Then the following are equivalent:

- (i) γ is hyperbolic;
- (ii) $\tau(\gamma) > 4$;
- (iii) γ is conjugate to a dilation, i.e. γ is conjugate to a Möbius transformation of \mathbb{H} of the form $z \mapsto kz$, for some $k > 0$.

Proof. We have already seen in Proposition 10.2.2 that (i) is equivalent to (ii).

Suppose that (iii) holds. Then γ is conjugate to a dilation. We have already seen that a dilation has two fixed points in $\partial\mathbb{H}$, namely 0 and ∞ . Hence γ also has exactly two fixed points in $\partial\mathbb{H}$. Hence (i) holds.

Finally, we prove that (i) implies (iii). We first make the remark that if γ fixes both 0 and ∞ then γ is a dilation. To see this, write

$$\gamma(z) = \frac{az + b}{cz + d}$$

where $ad - bc > 0$. As ∞ is a fixed point of γ , we must have that $c = 0$ (see Lecture 9). Hence $\gamma(z) = (az + b)/d$. As 0 is fixed, we must have that $b = 0$. Hence $\gamma(z) = (a/d)z$ so that γ is a dilation.

Suppose that γ is a hyperbolic Möbius transformation of \mathbb{H} . Then γ has two fixed points in $\partial\mathbb{H}$; denote them by ζ_1, ζ_2 .

First suppose that $\zeta_1 = \infty$ and $\zeta_2 \in \mathbb{R}$. Let $g(z) = z - \zeta_2$. Then the Möbius transformation $g\gamma g^{-1}$ is conjugate to γ and has fixed points at 0 and ∞ . By the above remark, $g\gamma g^{-1}$ is a dilation.

Now suppose that $\zeta_1 \in \mathbb{R}$ and $\zeta_2 \in \mathbb{R}$. We may assume that $\zeta_1 < \zeta_2$. Let g be the transformation

$$g(z) = \frac{z - \zeta_2}{z - \zeta_1}.$$

As $-\zeta_1 + \zeta_2 > 0$, this is a Möbius transformation of \mathbb{H} . Moreover, as $g(\zeta_1) = \infty$ and $g(\zeta_2) = 0$, we see that $g\gamma g^{-1}$ has fixed points at 0 and ∞ and is therefore a dilation. Hence γ is conjugate to a dilation. □

Exercise 11.2

Let $\gamma \in \text{Möb}(\mathbb{H})$ be a hyperbolic Möbius transformation of \mathbb{H} . By the above result, we know that γ is conjugate to a dilation $z \mapsto kz$. Find a relationship between $\tau(\gamma)$ and k .

§11.3 Elliptic transformations

To understand elliptic isometries it is easier to work in the Poincaré disc \mathbb{D} .

Recall from Exercise 6.2 that Möbius transformations of \mathbb{D} have the form

$$\gamma(z) = \frac{\alpha z + \beta}{\beta z + \bar{\alpha}} \tag{11.3.1}$$

where $\alpha, \beta \in \mathbb{C}$ and $|\alpha|^2 - |\beta|^2 > 0$. Again, we can normalise γ so that $|\alpha|^2 - |\beta|^2 = 1$. We have the same classification of Möbius transformations, but this time in the context of \mathbb{D} , as before:

- (i) γ is hyperbolic if it has 2 fixed points on $\partial\mathbb{D}$ and 0 fixed points in \mathbb{D} ,
- (ii) γ is parabolic if it has 1 fixed point on $\partial\mathbb{D}$ and 0 fixed points in \mathbb{D} ,
- (iii) γ is elliptic if it has 0 fixed points on $\partial\mathbb{D}$ and 1 fixed point in \mathbb{D} .

We can again classify Möbius transformations of \mathbb{D} by using the trace. If γ is a Möbius transformation of \mathbb{D} and is written in normalised form (11.3.1) then we define $\tau(\gamma) = (\alpha + \bar{\alpha})^2$. It is then easy to prove that:

- (i) γ is hyperbolic if and only if $\tau(\gamma) > 4$;
- (ii) γ is parabolic if and only if $\tau(\gamma) = 4$;
- (iii) γ is elliptic if and only if $\tau(\gamma) \in [0, 4)$.

There are two ways in which we can prove this. Firstly, we could solve the quadratic equation $\gamma(z_0) = z_0$ as in Lecture 9 and examine the sign of the discriminant (as in Lecture 10). Alternatively, we can use the map $h : \mathbb{H} \rightarrow \mathbb{D}$, $h(z) = (z - i)/(iz - 1)$ we introduced in Lecture 6 as follows. Recall that Möbius transformations of \mathbb{D} have the form $h\gamma h^{-1}$ where

γ is a Möbius transformation of \mathbb{H} . We can think of h as a ‘change of co-ordinates’ (from \mathbb{H} to \mathbb{D}). As in Lecture 10 we can see that γ is hyperbolic, parabolic, elliptic if and only if $h\gamma h^{-1}$ is hyperbolic, parabolic, elliptic, respectively. By considering traces of matrices, we can also see that $\tau(h\gamma h^{-1}) = \tau(\gamma)$.

Let γ be an elliptic Möbius transformation of \mathbb{D} , so that there is a unique fixed point in \mathbb{D} .

As an example of an elliptic transformation of the Poincaré disc \mathbb{D} , let $\theta \in (0, 2\pi)$ and consider the map

$$\gamma(z) = e^{i\theta} z.$$

This is a Möbius transformation of \mathbb{D} (take $\alpha = e^{i\theta/2}$ and $\beta = 0$ in (11.3.1)). It acts on \mathbb{D} by rotating the Poincaré disc around the origin by an angle of θ .

Proposition 11.3.1

Let $\gamma \in \text{Möb}(\mathbb{D})$ be a Möbius transformation of \mathbb{D} . The following are equivalent:

- (i) γ is elliptic;
- (ii) $\tau(\gamma) \in [0, 4)$;
- (iii) γ is conjugate to a rotation $z \mapsto e^{i\theta} z$.

Proof. We have already seen in Proposition 10.2.2 and the discussion above that (i) is equivalent to (ii).

Suppose that (iii) holds. A rotation has a unique fixed point (at the origin). If γ is conjugate to a rotation then it must also have a unique fixed point, and so is elliptic.

Finally, we prove that (i) implies (iii). Suppose that γ is elliptic and has a unique fixed point at $\zeta \in \mathbb{D}$. Let g be a Möbius transformation of \mathbb{D} that maps ζ to the origin 0. Then $g\gamma g^{-1}$ is a Möbius transformation of \mathbb{D} that is conjugate to γ and has a unique fixed point at 0. Suppose that

$$g\gamma g^{-1}(z) = \frac{\alpha z + \beta}{\beta z + \bar{\alpha}}$$

where $|\alpha|^2 - |\beta|^2 > 0$. As 0 is a fixed point, we must have that $\beta = 0$. Write α in polar form as $\alpha = re^{i\theta}$. Then

$$g\gamma g^{-1}(z) = \frac{\alpha}{\bar{\alpha}} z = \frac{re^{i\theta}}{re^{-i\theta}} z = e^{2i\theta} z$$

so that γ is conjugate to a rotation. □

Exercise 11.3

Let $\gamma \in \text{Möb}(\mathbb{D})$ be an elliptic Möbius transformation of \mathbb{D} . By the above result, we know that γ is conjugate to a rotation $z \mapsto e^{i\theta} z$. Find a relationship between $\tau(\gamma)$ and θ .

Remark. What do rotations look like in \mathbb{H} ? Recall the map $h : \mathbb{H} \rightarrow \mathbb{D}$ used to transfer results between \mathbb{H} and \mathbb{D} . If $\gamma(z) = e^{i\theta} z \in \text{Möb}(\mathbb{D})$ is a rotation of the Poincaré disc \mathbb{D} then $h^{-1}\gamma h \in \text{Möb}(\mathbb{H})$ is a Möbius transformation of \mathbb{H} of the form

$$h^{-1}\gamma h(z) = \frac{\cos(\theta/2)z + \sin(\theta/2)}{-\sin(\theta/2)z + \cos(\theta/2)} \tag{11.3.2}$$

This map has a unique fixed point at i . Maps of the form (11.3.2) are often called *rotations of \mathbb{H}* .

12. Fuchsian groups

§12.1 Introduction

Recall that the collection of Möbius transformations of \mathbb{H} , $\text{Möb}(\mathbb{H})$, and Möbius transformations of \mathbb{D} , $\text{Möb}(\mathbb{D})$, form a group. There are many subgroups of these groups and in this section we will study a particularly interesting class of subgroup. Because the following definition is so important, we give it here and explain what it means below.

Definition. A *Fuchsian group* is a discrete subgroup of either $\text{Möb}(\mathbb{H})$, the Möbius transformations of \mathbb{H} , or $\text{Möb}(\mathbb{D})$, the Möbius transformations of \mathbb{D} .

§12.2 Discreteness

The concept of discreteness plays an important role in many areas of geometry, topology and metric spaces.

A metric space is, roughly speaking, a mathematical space on which it is possible to define the distance between two points in the space. The concept of distance must satisfy some fairly natural assumptions: (i) the distance from a point to itself is zero, (ii) the distance from x to y is equal to the distance from y to x , and (iii) the triangle inequality: $d(x, y) \leq d(x, z) + d(z, y)$.

Examples of metric spaces include:

- (i) \mathbb{R}^n with the Euclidean metric

$$\begin{aligned} d((x_1, \dots, x_n), (y_1, \dots, y_n)) &= \|(x_1, \dots, x_n) - (y_1, \dots, y_n)\| \\ &= \sqrt{|x_1 - y_1|^2 + \dots + |x_n - y_n|^2}, \end{aligned} \tag{12.2.1}$$

- (ii) the upper half-plane \mathbb{H} with the metric $d_{\mathbb{H}}$ that we defined in Lecture 2.

Let (X, d) be a metric space. Heuristically, a subset $Y \subset X$ is discrete if every point $y \in Y$ is isolated, i.e., the other points of Y do not come arbitrarily close to y . More formally:

Definition. We say that a point $y \in Y$ is *isolated* if: there exists $\delta > 0$ such that if $y' \in Y$ and $y' \neq y$ then $d(y, y') > \delta$. That is, a point y in a subset Y is isolated if, for some $\delta > 0$, there are no other points of Y within distance δ of y .

Definition. A subset Y is said to be *discrete* if every point $y \in Y$ is isolated.

Examples.

1. In any metric space, a single point $\{x\}$ is discrete.

2. The set of integers \mathbb{Z} forms a discrete subset of the real line \mathbb{R} . To see this, let $n \in \mathbb{Z}$ be an integer and choose $\delta = 1/2$. Then if $|m - n| < \delta$, we see that m is an integer a distance at most $1/2$ from n ; this is only possible if $m = n$, as integers lie distance 1 apart.
3. The set of rationals \mathbb{Q} is not a discrete subgroup of \mathbb{R} : there are infinitely many distinct rationals arbitrarily close to any given rational.
4. The subset $Y = \{1, 1/2, 1/3, \dots, 1/n, \dots\}$ of \mathbb{R} is discrete. To see this, take $y = 1/n$. Choose $\delta = 1/n(n+1)$. Then if $y' \in Y$ satisfies $|y' - y| < 1/n(n+1)$ then $y' = 1/n$ (draw a picture!).
5. The subset $Y = \{1, 1/2, 1/3, \dots, 1/n, \dots\} \cup \{0\}$ is not discrete. This is because 0 is not isolated: points of the form $1/n$ can come arbitrarily close to 0. No matter how small we choose δ , there are non-zero points of Y lying within δ of 0.

We will be interested in discrete subgroups of $\text{Möb}(\mathbb{H})$. That is, we will be studying subgroups of Möbius transformations of \mathbb{H} that form discrete subsets of $\text{Möb}(\mathbb{H})$. To do this, we need to be able to say what it means for two Möbius transformations of \mathbb{H} to be near one another—we need to define a metric on the space $\text{Möb}(\mathbb{H})$ of Möbius transformations of \mathbb{H} .

Intuitively, it is clear what we mean for two Möbius transformations of \mathbb{H} to be close: two Möbius transformations of \mathbb{H} are *close* if the coefficients $(a, b; c, d)$ defining them are close. However, things are not quite so simple because, as we have seen in Lecture 9, different coefficients $(a, b; c, d)$ can give the same Möbius transformation.

To get around this problem, we can insist on writing all Möbius transformations of \mathbb{H} in a normalised form. Recall that the Möbius transformation $\gamma(z) = (az + b)/(cz + d)$ is *normalised* if $ad - bc = 1$. However, there is still some ambiguity because if

$$\gamma(z) = \frac{az + b}{cz + d}$$

is normalised, then so is

$$\gamma(z) = \frac{-az - b}{-cz - d}.$$

This, however, is the only ambiguity (see Lecture 9).

Thus we will say that the (normalised) Möbius transformations of \mathbb{H} given by $\gamma_1(z) = (a_1z + b_1)/(c_1z + d_1)$ and $\gamma_2(z) = (a_2z + b_2)/(c_2z + d_2)$ are close if either (a_1, b_1, c_1, d_1) , (a_2, b_2, c_2, d_2) are close or (a_1, b_1, c_1, d_1) , $(-a_2, -b_2, -c_2, -d_2)$ are close. If we wanted to make this precise and in particular have a formula, then we could define a metric on the space $\text{Möb}(\mathbb{H})$ of Möbius transformations of \mathbb{H} by setting

$$d_{\text{Möb}}(\gamma_1, \gamma_2) = \min\{\|(a_1, b_1, c_1, d_1) - (a_2, b_2, c_2, d_2)\|, \|(a_1, b_1, c_1, d_1) - (-a_2, -b_2, -c_2, -d_2)\|\}. \quad (12.2.2)$$

(Here $\|\cdot\|$ is the Euclidean metric in \mathbb{R}^4 defined by (12.2.1) in the case $n = 4$.) However, we will never use an explicit metric on $\text{Möb}(\mathbb{H})$ and prefer instead to think of Möbius transformations of \mathbb{H} being close if they ‘look close’ (secure in the knowledge that we could fill in the details using the metric given above if we had to).

We can also define a metric on $\text{Möb}(\mathbb{D})$ in exactly the same way. Again, we will never need to use the formula for this metric explicitly; instead, two Möbius transformations of \mathbb{D} are ‘close’ if (upto normalisation) the coefficients defining them are close.

§12.3 Fuchsian groups

Recall the following definition:

Definition. A *Fuchsian group* is a discrete subgroup of either $\text{Möb}(\mathbb{H})$ or $\text{Möb}(\mathbb{D})$.

Examples.

1. Any finite subgroup of $\text{Möb}(\mathbb{H})$ or $\text{Möb}(\mathbb{D})$ is a Fuchsian group. This is because any finite subset of any metric space is discrete.
2. As a specific example in the upper half-plane, let

$$\gamma_\theta(z) = \frac{\cos(\theta/2)z + \sin(\theta/2)}{-\sin(\theta/2)z + \cos(\theta/2)}$$

be a rotation around i . Let $q \in \mathbb{N}$. Then $\{\gamma_{2\pi j/q} \mid 0 \leq j \leq q-1\}$ is a finite subgroup.

In \mathbb{D} , this is the group $\{z \mapsto e^{2\pi j/q}z \mid j = 0, 1, \dots, q-1\}$ of rotations about 0 through angles that are multiples of $2\pi/q$.

3. The subgroup of integer translations $\{\gamma_n(z) = z + n \mid n \in \mathbb{Z}\}$ is a Fuchsian group. The subgroup of all translations $\{\gamma_b(z) = z + b \mid b \in \mathbb{R}\}$ is not a Fuchsian group as it is not discrete.
4. The subgroup $\Gamma = \{\gamma_n(z) = 2^n z \mid n \in \mathbb{Z}\}$ is a Fuchsian group.
5. If Γ is a Fuchsian group and $\Gamma_1 < \Gamma$ is a subgroup then Γ_1 is a Fuchsian group.
6. One of the most important Fuchsian groups is the *modular group* $\text{PSL}(2, \mathbb{Z})$. This is the group given by Möbius transformations of \mathbb{H} of the form

$$\gamma(z) = \frac{az + b}{cz + d}, \quad a, b, c, d \in \mathbb{Z}, \quad ad - bc = 1.$$

7. Let $q \in \mathbb{N}$. Define

$$\Gamma_q = \left\{ \gamma(z) = \frac{az + b}{cz + d} \mid a, b, c, d \in \mathbb{Z}, \quad ad - bc = 1, \quad b, c \text{ are divisible by } q \right\}.$$

This is called the *level q modular group* or the *congruence subgroup of order q* .

Exercise 12.1

Show that for each $q \in \mathbb{N}$, Γ_q , as defined above, is indeed a subgroup of $\text{Möb}(\mathbb{H})$.

Exercise 12.2

Fix $k > 0$, $k \neq 1$. Consider the subgroup of $\text{Möb}(\mathbb{H})$ generated by the Möbius transformations of \mathbb{H} given by

$$\gamma_1(z) = z + 1, \quad \gamma_2(z) = kz.$$

Is this a Fuchsian group? (Hint: consider $\gamma_2^{-n}\gamma_1^m\gamma_2^n(z)$.)

§12.4 A criterion for a subgroup to be a Fuchsian group

Recall that a subset is discrete if every point is isolated. To check that a subgroup is discrete, it is sufficient to check that the identity is isolated.

Proposition 12.4.1

Let Γ be a subgroup of $\text{Möb}(\mathbb{H})$. The following are equivalent:

- (i) Γ is a discrete subgroup of $\text{Möb}(\mathbb{H})$ (i.e. Γ is a Fuchsian group);
- (ii) the identity element of Γ is isolated.

Remark. The same statement holds in the case of the Poincaré disc model \mathbb{D} .

Proof. Clearly (i) implies (ii). The proof of (ii) implies (i) is straight-forward, but requires knowledge of concepts from metric spaces. The idea is to show that (i) the image of an isolated point under a continuous map is isolated, and (ii) the map defined on $\text{Möb}(\mathbb{H})$ by multiplication by a fixed element of $\text{Möb}(\mathbb{H})$ is continuous. Then if the identity Id is isolated, by considering the image of Id under multiplication by $\gamma \in \Gamma$, we see that γ is isolated. As γ is arbitrary, we are done. \square

§12.5 Orbits

Let Γ be a subgroup of $\text{Möb}(\mathbb{H})$.

Definition. Let $z \in \mathbb{H}$. The orbit $\Gamma(z)$ of z under Γ is the set of all points of \mathbb{H} that we can reach by applying elements of Γ to z :

$$\Gamma(z) = \{\gamma(z) \mid \gamma \in \Gamma\}.$$

The following result says that for subgroups of isometries of the hyperbolic plane, discreteness of the group is the same as discreteness of every orbit.

Proposition 12.5.1

Let Γ be a subgroup of $\text{Möb}(\mathbb{H})$. Then the following are equivalent:

- (i) Γ is a Fuchsian group;
- (ii) For each $z \in \mathbb{H}$, the orbit $\Gamma(z)$ is a discrete subset of \mathbb{H} .

Remark. The same statement holds in the case of the Poincaré disc model \mathbb{D} .

Proof. This is covered in the reading material on limit sets (see Proposition 24.2.4. Alternatively, see §2.2 in Katok. \square

Example. Let $\Gamma = \{\gamma_n \mid \gamma_n(z) = 2^n z, n \in \mathbb{Z}\}$. Fix $z \in \mathbb{H}$. Then the orbit of z is

$$\Gamma(z) = \{2^n z \mid n \in \mathbb{Z}\}.$$

We will show directly that $\Gamma(z)$ is a discrete subgroup of \mathbb{H} . To see this, first observe that the points $2^n z$ lie on the (Euclidean) straight line through the origin inclined at angle $\arg(z)$. Fix $2^n z$ and let $\delta = 2^{n-1}|z|$. It is easy to see that $|2^m z - 2^n z| \geq \delta$ whenever $m \neq n$. Hence $\Gamma(z)$ is discrete.

Remark. A subgroup Γ of $\text{Möb}(\mathbb{H})$ also acts on $\partial\mathbb{H}$. However, the orbit $\Gamma(z)$ of a point $z \in \partial\mathbb{H}$ under Γ need not be discrete, even if the group Γ itself is discrete. For example, consider the modular group:

$$\text{PSL}(2, \mathbb{Z}) = \left\{ \gamma(z) = \frac{az + b}{cz + d} \mid a, b, c, d \in \mathbb{Z}, ad - bc = 1 \right\}.$$

This is a Fuchsian group (and therefore discrete). However, the orbit of the point $0 \in \partial\mathbb{H}$ under $\text{PSL}(2, \mathbb{Z})$ is the set $\{b/d \mid ad - bc = 1\}$. It is easy to see that this set is equal to $\mathbb{Q} \cup \{\infty\}$, which is not a discrete subset of $\partial\mathbb{H}$ (because an irrational point on \mathbb{R} can always be arbitrarily well approximated by rationals).

13. Fundamental domains

§13.1 Open and closed subsets

We will need to say what it means for a subset of \mathbb{H} to be open or closed.

Definition. A subset $Y \subset \mathbb{H}$ is said to be *open* if for each $y \in Y$ there exists $\varepsilon > 0$ such that the open ball $B_\varepsilon(y) = \{z \in \mathbb{H} \mid d_{\mathbb{H}}(z, y) < \varepsilon\}$ of radius ε and centre y is contained in Y .

A subset $Y \subset \mathbb{H}$ is said to be *closed* if its complement $\mathbb{H} \setminus Y$ is open.

Remark. Recall from the exercises that hyperbolic circles are Euclidean circles (albeit with different radii and centres). Thus to prove a subset $Y \subset \mathbb{H}$ is open it is sufficient to find a Euclidean open ball around each point that is contained in Y . In particular, the open subsets of \mathbb{H} are the same as the open subsets of the (Euclidean) upper half-plane.

Examples.

1. The subset $\{z \in \mathbb{H} \mid 0 < \operatorname{Re}(z) < 1\}$ is open.
2. The subset $\{z \in \mathbb{H} \mid 0 \leq \operatorname{Re}(z) \leq 1\}$ is closed.
3. The subset $\{z \in \mathbb{H} \mid 0 < \operatorname{Re}(z) \leq 1\}$ is neither open nor closed.

Definition. Let $Y \subset \mathbb{H}$ be a subset. Then the *closure* of Y is the smallest closed subset containing Y . We denote the closure of Y by $\operatorname{cl}(Y)$.

For example, the closure of $\{z \in \mathbb{H} \mid 0 < \operatorname{Re}(z) < 1\}$ is $\{z \in \mathbb{H} \mid 0 \leq \operatorname{Re}(z) \leq 1\}$.

§13.2 Fundamental domains

Definition. Let Γ be a Fuchsian group. A *fundamental domain* F for Γ is an open subset of \mathbb{H} such that

- (i) $\bigcup_{\gamma \in \Gamma} \gamma(\operatorname{cl}(F)) = \mathbb{H}$,
- (ii) the images $\gamma(F)$ are pairwise disjoint; that is, $\gamma_1(F) \cap \gamma_2(F) = \emptyset$ if $\gamma_1, \gamma_2 \in \Gamma$, $\gamma_1 \neq \gamma_2$.

Remark. Notice that in (i) we have written $\gamma(\operatorname{cl}(F))$ (i.e. we first take the closure, then apply γ). We could instead have written $\operatorname{cl}(\gamma(F))$ (i.e. first apply γ , now take the closure). These two sets are equal. This follows from the fact that both γ and γ^{-1} are continuous maps. (See any text on metric spaces for more details.)

Thus F is a fundamental domain if every point lies in the closure of some image $\gamma(F)$ and if two distinct images do not overlap. We say that the images of F under Γ *tessellate* \mathbb{H} .

Remark. Some texts require fundamental domains to be *closed*. If this is the case then condition (i) is replaced by the assumption that $\bigcup_{\gamma \in \Gamma} \gamma(F) = \mathbb{H}$, and condition (ii) requires the set $\gamma(\text{int}(F))$ to be pairwise disjoint (here $\text{int}(F)$ denotes the *interior* of F , the largest open set contained inside F).

Example. Consider the subgroup Γ of $\text{Möb}(\mathbb{H})$ given by integer translations: $\Gamma = \{\gamma_n \mid \gamma_n(z) = z + n, n \in \mathbb{Z}\}$. This is a Fuchsian group.

Consider the set $F = \{z \in \mathbb{H} \mid 0 < \text{Re}(z) < 1\}$. This is an open set. Clearly if $\text{Re}(z) = a$ then $\text{Re}(\gamma_n(z)) = n + a$. Hence

$$\gamma_n(F) = \{z \in \mathbb{H} \mid n < \text{Re}(z) < n + 1\}$$

and

$$\gamma_n(\text{cl}(F)) = \{z \in \mathbb{H} \mid n \leq \text{Re}(z) \leq n + 1\}.$$

Hence $\mathbb{H} = \bigcup_{n \in \mathbb{Z}} \gamma_n(\text{cl}(F))$. It is also clear that if $\gamma_n(F)$ and $\gamma_m(F)$ intersect, then $n = m$. Hence F is a fundamental domain for Γ . See Figure 13.2.1.

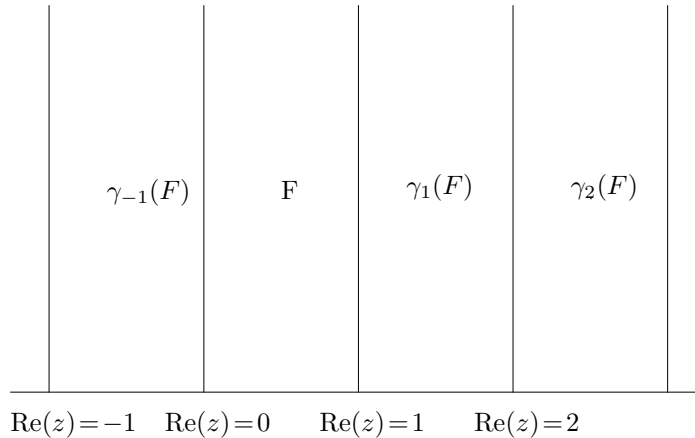

Figure 13.2.1: A fundamental domain and tessellation for $\Gamma = \{\gamma_n \mid \gamma_n(z) = z + n\}$

Example. Consider the subgroup $\Gamma = \{\gamma_n \mid \gamma_n(z) = 2^n z, n \in \mathbb{Z}\}$ of $\text{Möb}(\mathbb{H})$. This is a Fuchsian group.

Let $F = \{z \in \mathbb{H} \mid 1 < |z| < 2\}$. This is an open set. Clearly, if $1 < |z| < 2$ then $2^n < |\gamma_n(z)| < 2^{n+1}$. Hence

$$\gamma_n(F) = \{z \in \mathbb{H} \mid 2^n < |z| < 2^{n+1}\}$$

and

$$\gamma_n(\text{cl}(F)) = \{z \in \mathbb{H} \mid 2^n \leq |z| \leq 2^{n+1}\}.$$

Hence $\mathbb{H} = \bigcup_{n \in \mathbb{Z}} \gamma_n(\text{cl}(F))$. It is also clear that if $\gamma_n(F)$ and $\gamma_m(F)$ intersect, then $n = m$. Hence F is a fundamental domain for Γ . See Figure 13.2.2.

Fundamental domains are not necessarily unique. That is, for a given Fuchsian group there may be many different fundamental domains. For example, Figure 13.2.3 gives an example of a different fundamental domain for the Fuchsian group $\Gamma = \{\gamma_n \mid \gamma_n(z) =$

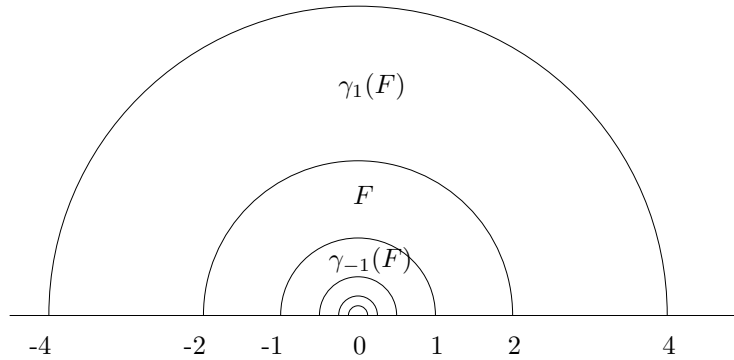

Figure 13.2.2: A fundamental domain and tessellation for $\Gamma = \{\gamma_n \mid \gamma_n(z) = 2^n z\}$

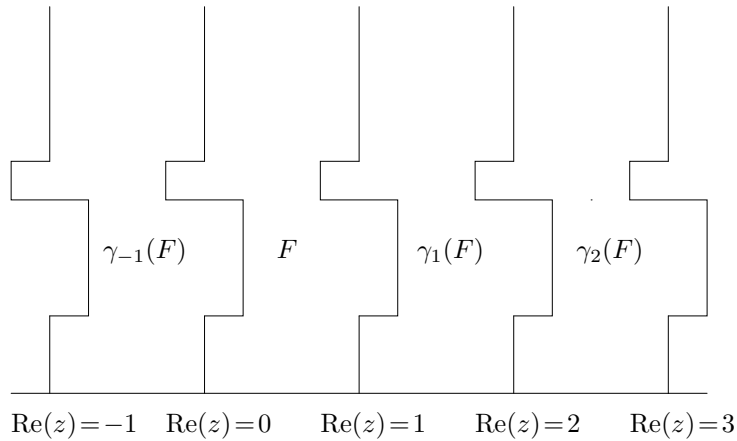

Figure 13.2.3: Another fundamental domain and tessellation for $\Gamma = \{\gamma_n \mid \gamma_n(z) = z + n\}$

$z + n, n \in \mathbb{Z}$. However, we have the following result which (essentially) says that any two fundamental regions have the same area. To state it precisely, we need to take care to avoid some pathological fundamental domains. Recall that the boundary ∂F of a set F is defined to be the set $\text{cl}(F) \setminus \text{int}(F)$; here $\text{cl}(F)$ is the closure of F and $\text{int}(F)$ is the interior of F .

Proposition 13.2.1

Let F_1 and F_2 be two fundamental domains for a Fuchsian group Γ , with $\text{Area}_{\mathbb{H}}(F_1) < \infty$. Assume that $\text{Area}_{\mathbb{H}}(\partial F_1) = 0$ and $\text{Area}_{\mathbb{H}}(\partial F_2) = 0$. Then $\text{Area}_{\mathbb{H}}(F_1) = \text{Area}_{\mathbb{H}}(F_2)$.

Proof. First notice that, for $i = 1, 2$, we have that $\text{Area}_{\mathbb{H}}(\text{cl}(F_i)) = \text{Area}_{\mathbb{H}}(F_i)$ for $i = 1, 2$ as $\text{Area}_{\mathbb{H}}(\partial F_i) = 0$. Now

$$\text{cl}(F_1) \supset \text{cl}(F_1) \cap \left(\bigcup_{\gamma \in \Gamma} \gamma(F_2) \right) = \bigcup_{\gamma \in \Gamma} (\text{cl}(F_1) \cap \gamma(F_2)).$$

As F_2 is a fundamental domain, the sets $\text{cl}(F_1) \cap \gamma(F_2)$ are pairwise disjoint. Hence, using the facts that (i) the area of the union of disjoint sets is the sum of the areas of the sets,

and (ii) Möbius transformations of \mathbb{H} preserve area we have that

$$\begin{aligned} \text{Area}_{\mathbb{H}}(\text{cl}(F_1)) &\geq \sum_{\gamma \in \Gamma} \text{Area}_{\mathbb{H}}(\text{cl}(F_1) \cap \gamma(F_2)) \\ &= \sum_{\gamma \in \Gamma} \text{Area}_{\mathbb{H}}(\gamma^{-1}(\text{cl}(F_1)) \cap F_2) \\ &= \sum_{\gamma \in \Gamma} \text{Area}_{\mathbb{H}}(\gamma(\text{cl}(F_1)) \cap F_2). \end{aligned}$$

Since F_1 is a fundamental domain we have that

$$\bigcup_{\gamma \in \Gamma} \gamma(\text{cl}(F_1)) = \mathbb{H}.$$

Hence

$$\sum_{\gamma \in \Gamma} \text{Area}_{\mathbb{H}}(\gamma(\text{cl}(F_1)) \cap F_2) \geq \text{Area}_{\mathbb{H}}\left(\bigcup_{\gamma \in \Gamma} \gamma(\text{cl}(F_1)) \cap F_2\right) = \text{Area}_{\mathbb{H}}(F_2).$$

Hence $\text{Area}_{\mathbb{H}}(F_1) = \text{Area}_{\mathbb{H}}(\text{cl}(F_1)) \geq \text{Area}_{\mathbb{H}}(F_2)$. Interchanging F_1 and F_2 in the above gives the reverse inequality. Hence $\text{Area}_{\mathbb{H}}(F_1) = \text{Area}_{\mathbb{H}}(F_2)$. \square

Let Γ be a Fuchsian group and let $\Gamma_1 < \Gamma$ be a subgroup of Γ . Then Γ_1 is a discrete subgroup of the Möbius group $\text{Möb}(\mathbb{H})$ and so is itself a Fuchsian group. The following relates properties of fundamental domains for Γ_1 and Γ .

Proposition 13.2.2

Let Γ be a Fuchsian group and suppose that Γ_1 is a subgroup of Γ of index n . Let

$$\Gamma = \Gamma_1\gamma_1 \cup \Gamma_1\gamma_2 \cup \cdots \cup \Gamma_1\gamma_n$$

be a decomposition of Γ into cosets of Γ_1 . Let F be a fundamental domain for Γ . Then:

- (i) $F_1 = \gamma_1(F) \cup \gamma_2(F) \cup \cdots \cup \gamma_n(F)$ is a fundamental domain for Γ_1 ;
- (ii) if $\text{Area}_{\mathbb{H}}(F)$ is finite then $\text{Area}_{\mathbb{H}}(F_1) = n\text{Area}_{\mathbb{H}}(F)$.

Proof. See Theorem 3.1.2 in Katok. Again, as in Proposition 13.2.1, in (ii) we need the additional technical hypothesis that $\text{Area}_{\mathbb{H}}(\partial F) = 0$. \square

So far, we do not yet know that there exists a fundamental domain for a given Fuchsian group. There are several methods of constructing fundamental domains and we discuss one such method in the next few lectures.

Exercise 13.1

Figures 13.2.1 and 13.2.2 illustrate two tessellations of \mathbb{H} . What do these tessellations look like in the Poincaré disc \mathbb{D} ?

14. Dirichlet polygons: the construction

§14.1 Recap

Let Γ be a Fuchsian group. Recall that a Fuchsian group is a discrete subgroup of the group $\text{Möb}(\mathbb{H})$ of all Möbius transformations of \mathbb{H} . In Lecture 13, we defined the notion of a fundamental domain F . Recall that a subset $F \subset \mathbb{H}$ is a fundamental domain if, essentially, the images $\gamma(F)$ of F under the Möbius transformations $\gamma \in \Gamma$ tessellate (or tile) the upper half-plane \mathbb{H} .

In Lecture 13 we saw some specific examples of fundamental domains. For example, we saw that the set $\{z \in \mathbb{H} \mid 0 < \text{Re}(z) < 1\}$ is a fundamental domain for the group of integer translations $\{\gamma_n(z) = z + n \mid n \in \mathbb{Z}\}$. However, we do not yet know that each Fuchsian group possesses a fundamental domain. The purpose of the next two lectures is to give a method for constructing a fundamental domain for a given Fuchsian group.

The fundamental domain that we construct is called a *Dirichlet polygon*. It is worth remarking that the construction that we give below works in far more general circumstances than those described here. We also remark that there are other methods for constructing fundamental domains that, in general, give different fundamental domains than a Dirichlet polygon; such an example is the Ford fundamental domain which is described in Katok's book.

The construction given below is written in terms of the upper half-plane \mathbb{H} . The same construction works in the Poincaré disc \mathbb{D} .

§14.2 Convex polygons as intersections of half-planes

In Lecture 7 we defined a polygon as the region bounded by a finite set of geodesic segments. It will be useful to slightly modify this definition.

Definition. Let C be a geodesic in \mathbb{H} . Then C divides \mathbb{H} into two components. These components are called *half-planes*.

For example, the imaginary axis determines two half-planes: $\{z \in \mathbb{H} \mid \text{Re}(z) < 0\}$ and $\{z \in \mathbb{H} \mid \text{Re}(z) > 0\}$. The geodesic given by the semi-circle of unit radius centred at the origin also determines two half-planes (although they no longer look like *Euclidean* half-planes): $\{z \in \mathbb{H} \mid |z| < 1\}$ and $\{z \in \mathbb{H} \mid |z| > 1\}$.

We define a convex hyperbolic polygon as follows.

Definition. A convex hyperbolic polygon is the intersection of a finite number of half-planes.

Exercise 14.1

(Included for completeness only.) Show that a convex hyperbolic polygon is an open subset of \mathbb{H} . To do this, first show that a half-plane is an open set. Then show that the intersection of a finite number of open sets is open.

One difference between this definition of a hyperbolic polygon and the more naive definition given in Lecture 7 is that we now allow for the possibility of an edge of a hyperbolic polygon to be an arc of the circle at infinity. See Figure 14.2.1.

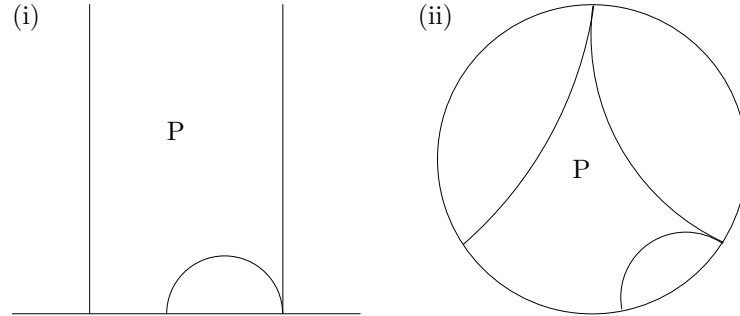

Figure 14.2.1: A polygon with one edge on the boundary (i) in the upper half-plane, (ii) in the Poincaré disc

§14.3 Perpendicular bisectors

Let $z_1, z_2 \in \mathbb{H}$. Recall that $[z_1, z_2]$ is the segment of the unique geodesic from z_1 to z_2 . The perpendicular bisector of $[z_1, z_2]$ is defined to be the unique geodesic perpendicular to $[z_1, z_2]$ that passes through the midpoint of $[z_1, z_2]$.

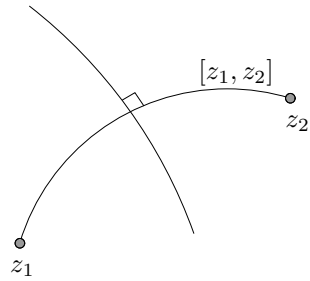

Figure 14.3.2: The perpendicular bisector of $[z_1, z_2]$

Proposition 14.3.1

Let $z_1, z_2 \in \mathbb{H}$. The line determined by the equation

$$d_{\mathbb{H}}(z, z_1) = d_{\mathbb{H}}(z, z_2)$$

is the perpendicular bisector of the line segment $[z_1, z_2]$.

Proof. By applying a Möbius transformation of \mathbb{H} , we can assume that both z_1 and z_2 lie on the imaginary axis and $z_1 = i$. Write $z_2 = ir^2$ for some $r > 0$ and there is no loss in generality (by applying the Möbius transformation $z \mapsto -1/z$ if required) that $r > 1$.

By using Proposition 4.2.1 it follows that the mid-point of $[i, ir^2]$ is at the point ir . It is clear that the unique geodesic through ir that meets the imaginary axis at right-angles is given by the semi-circle of radius r centred at 0.

Recall from Proposition 5.5.2 that

$$\cosh d_{\mathbb{H}}(z, w) = 1 + \frac{|z - w|^2}{2 \operatorname{Im} z \operatorname{Im} w}.$$

In our setting this implies that

$$|z - i|^2 = \frac{|z - ir^2|^2}{r^2}.$$

This easily simplifies to $|z| = r$, i.e. z lies on the semicircle of radius r , centred at 0. \square

Exercise 14.2

- (i) Write $z_1 = x_1 + iy_1$, $z_2 = x_2 + iy_2$, $z_1, z_2 \in \mathbb{H}$. Show that the perpendicular bisector of $[z_1, z_2]$ can also be written as

$$\{z \in \mathbb{H} \mid y_2|z - z_1|^2 = y_1|z - z_2|^2\}.$$

- (ii) Hence describe the perpendicular bisector of the arc of geodesic between $1 + 2i$ and $(6 + 8i)/5$.

§14.4 Constructing Dirichlet polygons

Let Γ be a Fuchsian group. We are now in a position to describe how to construct a Dirichlet polygon for Γ . Before we can do that, we need to state the following technical result:

Lemma 14.4.1

Let Γ be a Fuchsian group. Then there exists a point $p \in \mathbb{H}$ that is not fixed by any non-trivial element of Γ . (That is, $\gamma(p) \neq p$ for all $\gamma \in \Gamma \setminus \{\operatorname{Id}\}$.)

Proof. This is covered in the reading material on limit sets. See also Lemma 2.2.5 in Katok. \square

Let Γ be a Fuchsian group and let $p \in \mathbb{H}$ be a point such that $\gamma(p) \neq p$ for all $\gamma \in \Gamma \setminus \{\operatorname{Id}\}$. Let γ be an element of Γ and suppose that γ is not the identity. The set

$$\{z \in \mathbb{H} \mid d_{\mathbb{H}}(z, p) < d_{\mathbb{H}}(z, \gamma(p))\}$$

consists of all points $z \in \mathbb{H}$ that are closer to p than to $\gamma(p)$.

We define the *Dirichlet region* to be:

$$D(p) = \{z \in \mathbb{H} \mid d_{\mathbb{H}}(z, p) < d_{\mathbb{H}}(z, \gamma(p)) \text{ for all } \gamma \in \Gamma \setminus \{\operatorname{Id}\}\},$$

Thus the Dirichlet region is the set of all points z that are closer to p than to any other point in the orbit $\Gamma(p) = \{\gamma(p) \mid \gamma \in \Gamma\}$ of p under Γ .

To better describe the Dirichlet region consider the following procedure:

- (i) Choose $p \in \mathbb{H}$ such that $\gamma(p) \neq p$ for all $\gamma \in \Gamma \setminus \{\operatorname{Id}\}$.
- (ii) For a given $\gamma \in \Gamma \setminus \{\operatorname{Id}\}$ construct the geodesic segment $[p, \gamma(p)]$.
- (iii) Take $L_p(\gamma)$ to be the perpendicular bisector of $[p, \gamma(p)]$.

(iv) Let $H_p(\gamma)$ be the half-plane determined by $L_p(\gamma)$ that contains p . (Thus by Proposition 14.3.1 $H_p(\gamma)$ consists of all points $z \in \mathbb{H}$ that are closer to p than to $\gamma(p)$.)

(v) Then

$$D(p) = \bigcap_{\gamma \in \Gamma \setminus \{\text{Id}\}} H_p(\gamma).$$

Theorem 14.4.2

Let Γ be a Fuchsian group and let p be a point not fixed by any non-trivial element of Γ . Then the Dirichlet region $D(p)$ is a fundamental domain for Γ . Moreover, if $\text{Area}_{\mathbb{H}}(D(p)) < \infty$ then $D(p)$ is a convex hyperbolic polygon (in the sense of §14.2); in particular it has finitely many edges.

Remarks.

1. There are many other hypotheses that ensure that $D(p)$ is a convex hyperbolic polygon with finitely many edges; requiring $D(p)$ to have finite hyperbolic area is probably the simplest. Fuchsian groups that have a convex hyperbolic polygon with finitely many edges as a Dirichlet region are called *geometrically finite*.
2. If $D(p)$ has finitely many edges then we refer to $D(p)$ as a *Dirichlet polygon*. Notice that some of these edges may be arcs of $\partial\mathbb{H}$. If there are finitely many edges then there are also finitely many vertices (some of which may be on $\partial\mathbb{H}$).
3. The Dirichlet polygon $D(p)$ depends on p . If we choose a different point p , then we may obtain a different polygon with different properties, such as the number of edges. Given a Fuchsian group Γ , Beardon (Theorem 9.4.5) describes the properties that a Dirichlet polygon $D(p)$ will have for a typical point p .

Proof. There are two things to show here: namely, that $D(p)$ is a convex hyperbolic polygon, and that $D(p)$ is a fundamental domain. Both of these facts rely on technical properties of Fuchsian groups that we have chosen to avoid, and we do not go into them here. See Theorem 6.17 in Anderson or §§2,3 in Katok. \square

15. Dirichlet polygons: examples

§15.1 Recap

In Lecture 14 we saw how to construct a Dirichlet polygon for a given Fuchsian group. Let us recall the procedure:

- (i) Choose $p \in \mathbb{H}$ such that $\gamma(p) \neq p$ for all $\gamma \in \Gamma \setminus \{\text{id}\}$.
- (ii) Let $\gamma \in \Gamma \setminus \{\text{id}\}$. Construct the geodesic segment $[p, \gamma(p)]$.
- (iii) Let $L_p(\gamma)$ denote the perpendicular bisector of $[p, \gamma(p)]$.
- (iv) Let $H_p(\gamma)$ denote the half-plane determined by $L_p(\gamma)$ that contains p .
- (v) Let

$$D(p) = \bigcap_{\gamma \in \Gamma \setminus \{\text{id}\}} H_p(\gamma).$$

§15.2 The group of all integer translations

Proposition 15.2.1

Let Γ be the Fuchsian group $\{\gamma_n \mid \gamma_n(z) = z + n, n \in \mathbb{Z}\}$. Then

$$D(i) = \{z \in \mathbb{H} \mid -1/2 < \text{Re}(z) < 1/2\}.$$

Proof. Let $p = i$. Then clearly $\gamma_n(p) = i + n \neq p$ so that p is not fixed by any non-trivial element of Γ . As $\gamma_n(p) = i + n$, it is clear that the perpendicular bisector of $[p, \gamma_n(p)]$ is the vertical straight line with real part $n/2$. Hence

$$H_p(\gamma_n) = \begin{cases} \{z \in \mathbb{H} \mid \text{Re}(z) < n/2\} & \text{if } n > 0, \\ \{z \in \mathbb{H} \mid \text{Re}(z) > n/2\} & \text{if } n < 0. \end{cases}$$

Hence

$$\begin{aligned} D(p) &= \bigcap_{\gamma \in \Gamma \setminus \{\text{Id}\}} H_p(\gamma) \\ &= H_p(\gamma_1) \cap H_p(\gamma_{-1}) \\ &= \{z \in \mathbb{H} \mid -1/2 < \text{Re}(z) < 1/2\}. \end{aligned}$$

□

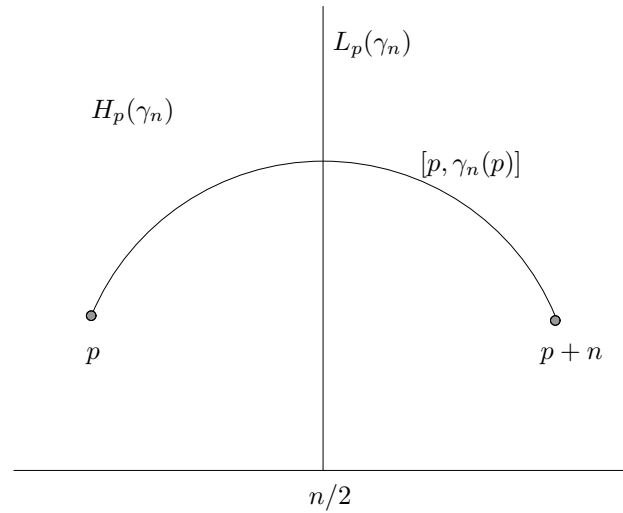

Figure 15.2.1: The half-plane determined by the perpendicular bisector of the geodesic segment $[p, p + n]$

§15.3 Groups of rotations

Proposition 15.3.1

Fix $n > 0$ and let Γ be the discrete group of Möbius transformations of \mathbb{D} given by $\Gamma = \{\gamma_k \mid \gamma_k(z) = e^{2\pi ik/n}z, k = 0, 1, \dots, n - 1\}$. Let $p = 1/2$. Then

$$D(p) = \{z \in \mathbb{D} \mid -\pi/n < \arg z < \pi/n\}.$$

Proof. Clearly the only fixed point of γ_n is the origin, so that we may take any $p \in \mathbb{D} \setminus \{0\}$. Let us take $p = 1/2$. Then $\gamma_k(p) = (e^{2\pi ik/n})/2$. The geodesic segment $[p, \gamma_k(p)]$ is an arc of semi-circle and it is easy to see that the perpendicular bisector $L_p(\gamma_k)$ of this arc is the

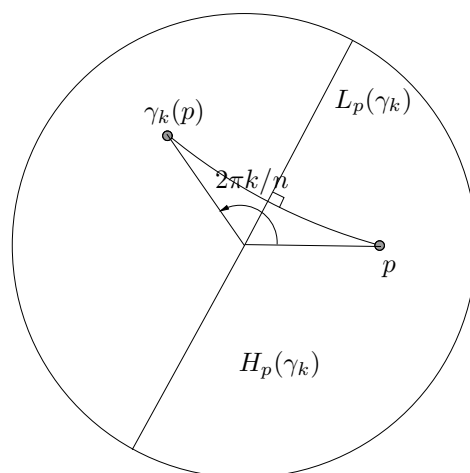

Figure 15.3.2: The half-plane determined by the perpendicular bisector of the geodesic segment $[p, e^{2\pi ik/n}p]$

diameter of \mathbb{D} inclined at angle $(2\pi k/n)/2 = \pi k/n$. See Figure 15.3.2. Hence $H_p(\gamma_k)$ is a

sector of the unit disc bounded by the diameter $L_p(\gamma_k)$. Taking the intersection, we see that

$$D(p) = \{z \in \mathbb{D} \mid -\pi/n < \arg z < \pi/n\}.$$

The tessellation of the Poincaré disc in the case $n = 7$ is illustrated in Figure 15.3.3. \square

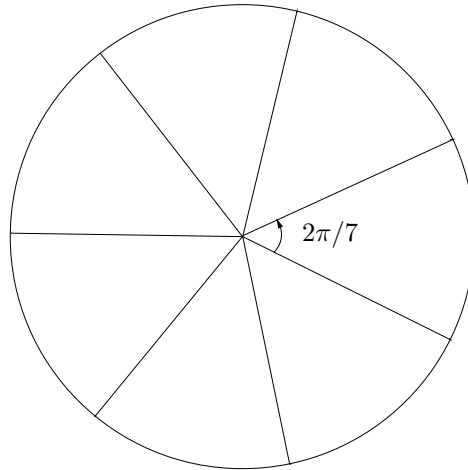

Figure 15.3.3: The tessellation of \mathbb{D} in the case when $n = 7$

§15.4 The modular group

Proposition 15.4.1

A Dirichlet polygon for the modular group $\text{PSL}(2, \mathbb{Z})$ is given by:

$$D(p) = \{z \in \mathbb{H} \mid |z| > 1, -1/2 < \text{Re}(z) < 1/2\}.$$

(Here $p = ki$ for any $k > 1$.)

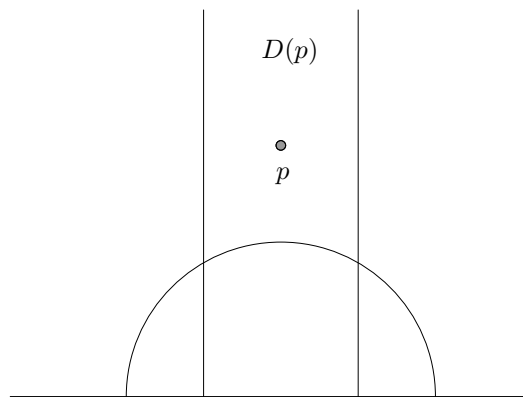

Figure 15.4.4: A Dirichlet polygon for $\text{PSL}(2, \mathbb{Z})$

Proof. It is easy to check that if $p = ki$ for $k > 1$ then p is not fixed under any non-trivial element of $\text{PSL}(2, \mathbb{Z})$.

Consider the Möbius transformations of \mathbb{H} given by $\gamma_1(z) = z + 1$ and $\gamma_2(z) = -1/z$. Clearly these lie in $\text{PSL}(2, \mathbb{Z})$.

The perpendicular bisector of $[p, \gamma_1(p)] = [p, p + 1]$ is easily seen to be the vertical line $\text{Re}(z) = 1/2$. Hence $H_p(\gamma_1) = \{z \in \mathbb{H} \mid \text{Re}(z) < 1/2\}$. Similarly, $H_p(\gamma_1^{-1}) = \{z \in \mathbb{H} \mid \text{Re}(z) > -1/2\}$.

The geodesic segment $[p, \gamma_2(p)]$ is the arc of imaginary axis between ki and i/k . By using Proposition 4.2.1 it follows that the perpendicular bisector of $[p, \gamma_2(p)]$ is the semi-circle of radius 1 centred at the origin. Hence $H_p(\gamma_2) = \{z \in \mathbb{H} \mid |z| > 1\}$.

Let $F = H_p(\gamma_1) \cap H_p(\gamma_1^{-1}) \cap H_p(\gamma_2)$. Then

$$D(p) = \bigcap_{\gamma \in \text{PSL}(2, \mathbb{Z}) \setminus \{\text{Id}\}} H_p(\gamma) \subset \bigcap_{\gamma = \gamma_1, \gamma_1^{-1}, \gamma_2} H_p(\gamma) = F.$$

It remains to show that this inclusion is an equality, i.e. $D(p) = F$. Suppose for a contradiction that this is not the case, i.e. $D(p) \subset F$ but $D(p) \neq F$. Then as $D(p)$ is a fundamental domain, there exists a point $z_0 \in D(p) \subset F$ and $\gamma \in \text{PSL}(2, \mathbb{Z}) \setminus \{\text{Id}\}$ such that $\gamma(z_0) \in F$. We show that this can not happen. To see this, write

$$\gamma(z) = \frac{az + b}{cz + d}$$

where $a, b, c, d \in \mathbb{Z}$ and $ad - bc = 1$. Then

$$|cz_0 + d|^2 = c^2|z_0|^2 + 2\text{Re}(z_0)cd + d^2 > c^2 + d^2 - |cd| = (|c| - |d|)^2 + |cd|,$$

since $|z_0| > 1$ and $\text{Re}(z_0) > -1/2$. This lower bound is a non-negative integer. Moreover, it is non-zero, for it were zero then both $c = 0$ and $d = 0$ which contradicts the fact that $ad - bc = 1$. Thus the lower bound is at least 1, so that $|cz_0 + d|^2 > 1$. Hence

$$\text{Im}(\gamma(z_0)) = \frac{\text{Im } z_0}{|cz_0 + d|^2} < \text{Im } z_0.$$

Repeating the above argument with z_0 replaced by $\gamma(z_0)$ and γ replaced by γ^{-1} we see that $\text{Im } z_0 < \text{Im}(\gamma(z_0))$, a contradiction. \square

Exercise 15.1

Let $\Gamma = \{\gamma_n \mid \gamma_n(z) = 2^n z, n \in \mathbb{Z}\}$. This is a Fuchsian group. Choose a suitable $p \in \mathbb{H}$ and construct a Dirichlet polygon $D(p)$.

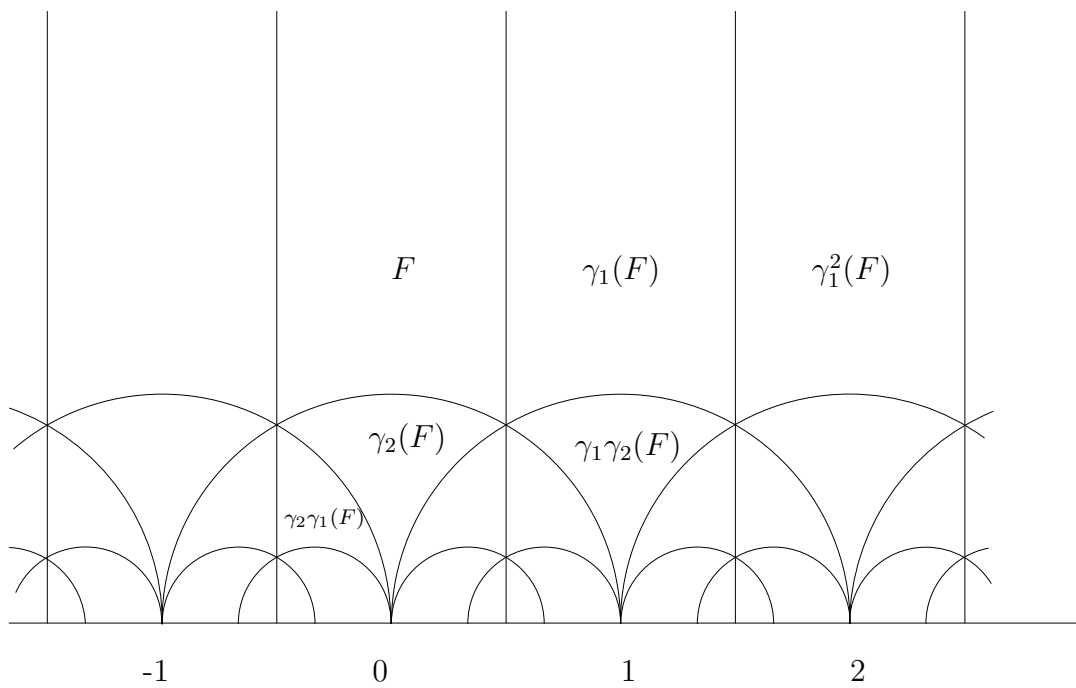

Figure 15.4.5: The tessellation of \mathbb{H} determined by the Dirichlet polygon given in Proposition 15.4.1 for the modular group

16. Side-pairing transformations

§16.1 Side-pairing transformations

Let D be a hyperbolic polygon. A *side* $s \subset \mathbb{H}$ of D is an edge of D in \mathbb{H} equipped with an orientation. That is, a side of D is an edge which starts at one vertex and ends at another.

Let Γ be a Fuchsian group and let $D(p)$ be a Dirichlet polygon for Γ . We assume that $D(p)$ has finitely many sides. Let s be a side of D . Suppose that for some $\gamma \in \Gamma \setminus \{\text{Id}\}$, we have that $\gamma(s)$ is also a side of $D(p)$. Note that $\gamma^{-1} \in \Gamma \setminus \{\text{Id}\}$ maps the side $\gamma(s)$ back to the side s .

Definition. We say that the sides s and $\gamma(s)$ are *paired* and call γ a *side-pairing transformation*. (As we shall see, it can happen that s and $\gamma(s)$ are the same side, albeit with opposing orientations; in this case, we say that s is paired with itself.)

Given a side s of a Dirichlet polygon $D(p)$, we can explicitly find a side-pairing transformation associated to it. By the way in which $D(p)$ is constructed, we see that s is contained in the perpendicular bisector $L_p(\gamma_1)$ of the geodesic segment $[p, g(p)]$, for some $g \in \Gamma \setminus \{\text{Id}\}$. One can show that the Möbius transformation $\gamma = g^{-1}$ maps s to another side of $D(p)$. See Figure 16.1.1. We often denote by γ_s the side-pairing transformation associated to the side s .

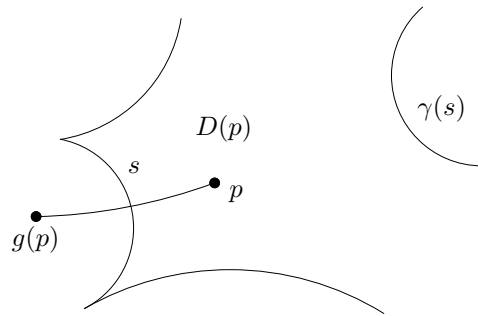

Figure 16.1.1: The transformation $\gamma = g^{-1}$ is associated to the side s of $D(p)$

§16.2 Examples of side-pairing transformations

Let us calculate some examples of side-pairing transformations.

Example. Let $\Gamma = \{\gamma_n \mid \gamma_n(z) = z + n, n \in \mathbb{Z}\}$ be the Fuchsian group of integer translations. We have seen that if $p = i$ then $D(p) = \{z \in \mathbb{H} \mid -1/2 < \text{Re}(z) < 1/2\}$ is a Dirichlet polygon for Γ .

Let s be the side $s = \{z \in \mathbb{H} \mid \text{Re}(z) = -1/2\}$. Then s is the perpendicular bisector of $[p, p - 1] = [p, g(p)]$. Hence $\gamma_s(z) = g^{-1}(z) = z + 1$ so that $\gamma_s(s) = s'$ where $s' = \{z \in \mathbb{H} \mid \text{Re}(z) = 1/2\}$.

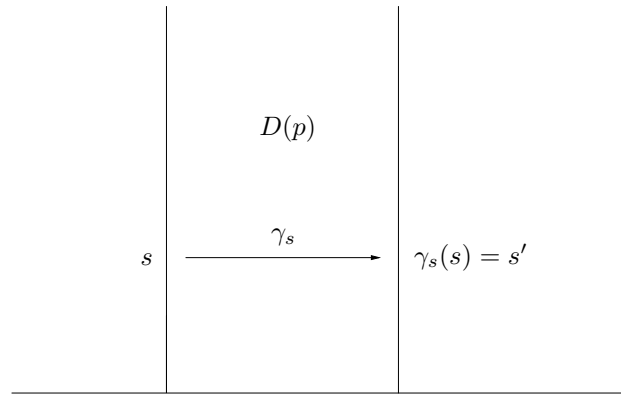

Figure 16.2.2: A side-pairing map for $\Gamma = \{\gamma_n \mid \gamma_n(z) = z + n\}$

Example. Consider the modular group $\Gamma = \text{PSL}(2, \mathbb{Z})$. We have seen that a fundamental domain for Γ is given by the set $D(p) = \{z \in \mathbb{H} \mid -1/2 < \text{Re}(z) < 1/2, |z| > 1\}$, where $p = ki$ for any $k > 1$. This polygon has three sides:

$$\begin{aligned} s_1 &= \{z \in \mathbb{H} \mid \text{Re}(z) = -1/2, |z| > 1\} \\ s_2 &= \{z \in \mathbb{H} \mid \text{Re}(z) = 1/2, |z| > 1\} \\ s_3 &= \{z \in \mathbb{H} \mid |z| = 1, -1/2 < \text{Re}(z) < 1/2\}. \end{aligned}$$

As in the above example, it is clear that $\gamma_{s_1}(z) = z + 1$ so that γ_{s_1} pairs s_1 with s_2 . The side pairing transformation associated to the side s_2 is $\gamma_{s_2}(z) = z - 1$. Consider s_3 . This is the perpendicular bisector of $[p, -1/p] = [p, \gamma_{s_3}^{-1}(p)]$ where $\gamma_{s_3}(z) = -1/z$. Hence $\gamma_{s_3}(z) = -1/z$ is a side-pairing transformation and pairs s_3 with itself.

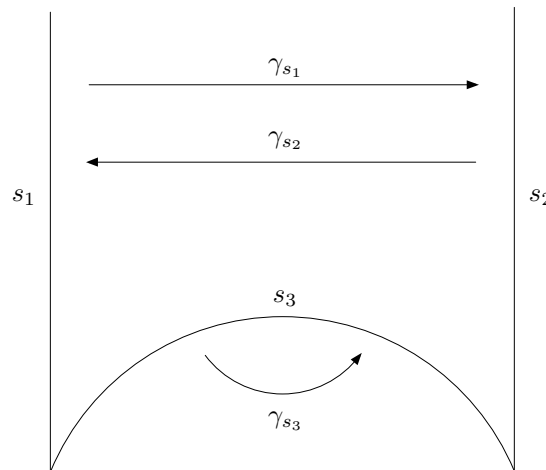

Figure 16.2.3: Side-pairing transformations for the modular group: s_1 is paired with s_2 and s_3 is paired with itself

Exercise 16.1

Take $\Gamma = \{\gamma_n \mid \gamma_n(z) = 2^n z, n \in \mathbb{Z}\}$. Calculate the side-pairing transformations for the Dirichlet polygon calculated in Exercise 15.1.

§16.3 Representing the side-pairing transformations in a diagram

Often it is convenient to indicate which sides of $D(p)$ are paired and how the side-pairing transformations act by recording the information in a diagram such as in Figure 16.3.4. Here, the sides with an equal number of arrowheads are paired and the pairing preserves

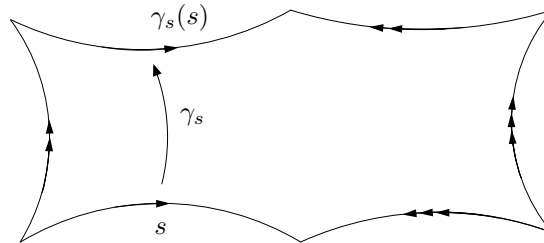

Figure 16.3.4: The side s' is mapped to the side s by γ_s . The sides with an equal number of arrowheads are paired

the direction of the arrows denoting the orientation of the sides.

17. Elliptic cycles

§17.1 Elliptic cycles

From now on we shall switch automatically between the upper half-plane \mathbb{H} and the Poincaré disc, depending on which model is most appropriate to use in a given context. Often we shall refer to \mathbb{H} , but draw pictures in \mathbb{D} ; we can do this as the map constructed in Lecture 6 allows us to switch between the two at will.

Let Γ be a Fuchsian group and let $D = D(p)$ be a Dirichlet polygon for Γ . We assume that all the vertices of $D(p)$ lie inside \mathbb{H} (later we shall see many examples where this happens). In Lecture 16 we saw how to associate to each side s of $D(p)$ a side-pairing transformation $\gamma_s \in \Gamma \setminus \{\text{Id}\}$ that pairs s with another side $\gamma_s(s)$ of $D(p)$.

Recall that we indicate which sides of D are paired and how the side-pairing transformations act by recording the information in a diagram as follows: the sides with an equal number of arrowheads are paired and the pairing preserves the direction of the arrows denoting the orientation of the sides.

Notice that each vertex v of D is mapped to another vertex of D under a side-pairing transformation associated to a side with end point at v .

Each vertex v of D has two sides s and $*s$ of D with end points at v . Let the pair (v, s) denote a vertex v of D and a side s of D with an endpoint at v . We denote by $*(v, s)$ the pair comprising of the vertex v and the other side $*s$ that ends at v .

Consider the following procedure:

- (i) Let $v = v_0$ be a vertex of D and let s_0 be a side with an endpoint at v_0 . Let γ_1 be the side-pairing transformation associated to the side s_0 . Thus γ_1 maps s_0 to another side s_1 of D .
- (ii) Let $s_1 = \gamma_1(s_0)$ and let $v_1 = \gamma_1(v_0)$. This gives a new pair (v_1, s_1) .
- (iii) Now consider the pair $*(v_1, s_1)$. This is the pair consisting of the vertex v_1 and the side $*s_1$ (i.e. the side of D other than s_1 with an endpoint at v_1).
- (iv) Let γ_2 be the side-pairing transformation associated to the side $*s_1$. Then $\gamma_2(*s_1)$ is a side s_2 of D and $\gamma_2(v_1) = v_2$, a vertex of D .
- (v) Repeat the above inductively. See Figure 17.1.1.

Thus we obtain a sequence of pairs of vertices and sides:

$$\begin{array}{l}
 \begin{pmatrix} v_0 \\ s_0 \end{pmatrix} \xrightarrow{\gamma_1} \begin{pmatrix} v_1 \\ s_1 \end{pmatrix} \xrightarrow{*} \begin{pmatrix} v_1 \\ *s_1 \end{pmatrix} \\
 \xrightarrow{\gamma_2} \begin{pmatrix} v_2 \\ s_2 \end{pmatrix} \xrightarrow{*} \dots \\
 \xrightarrow{\gamma_i} \begin{pmatrix} v_i \\ s_i \end{pmatrix} \xrightarrow{*} \begin{pmatrix} v_i \\ *s_i \end{pmatrix} \\
 \xrightarrow{\gamma_{i+1}} \begin{pmatrix} v_{i+1} \\ s_{i+1} \end{pmatrix} \xrightarrow{*} \dots
 \end{array}$$

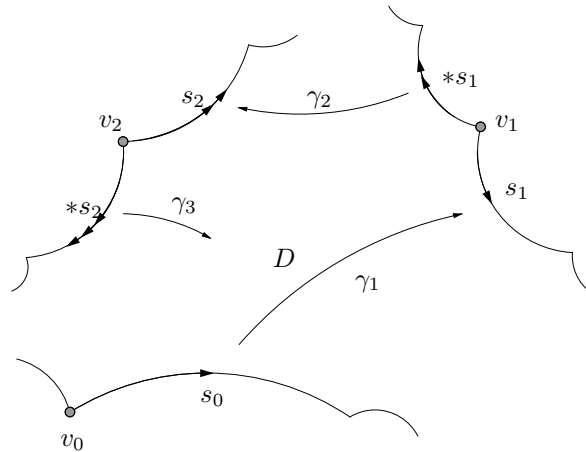

Figure 17.1.1: The pair (v_0, s_0) is mapped to (v_1, s_1) , which is mapped to $(v_1, *s_1)$, which is mapped to (v_2, s_2) , etc

As there are only finitely many pairs (v, s) , this process of applying a side-pairing transformation followed by applying $*$ must eventually return to the initial pair (v_0, s_0) . Let n be the least integer $n > 0$ for which $(v_n, *s_n) = (v_0, s_0)$.

Definition. The sequence of vertices $\mathcal{E} = v_0 \rightarrow v_1 \rightarrow \dots \rightarrow v_{n-1}$ is called an *elliptic cycle*. The transformation $\gamma_n \gamma_{n-1} \dots \gamma_2 \gamma_1$ is called an *elliptic cycle transformation*.

As there are only finitely many pairs of vertices and sides, we see that there are only finitely many elliptic cycles and elliptic cycle transformations.

Example. Consider the polygon in Figure 17.1.2. Notice that we can label the side-pairing transformations in any way we choose. Thus in Figure 17.1.2 the map γ_2 is an isometry that maps the side $s_6 = AF$ to the side $s_4 = DE$. Notice the orientation: γ_2 maps the vertex A to the vertex D , and the vertex F to the vertex E . We follow the

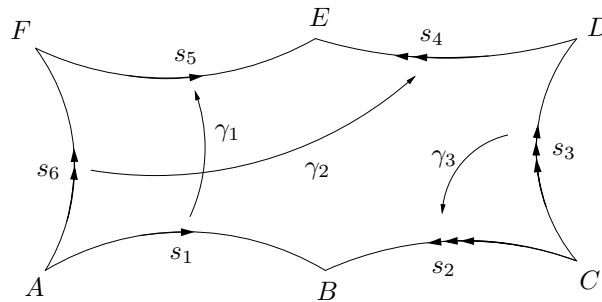

Figure 17.1.2: An example of a polygon with sides, vertices and side-pairing transformations labelled

procedure described above:

$$\begin{pmatrix} A \\ s_1 \end{pmatrix} \xrightarrow{\gamma_1} \begin{pmatrix} F \\ s_5 \end{pmatrix} \xrightarrow{*} \begin{pmatrix} F \\ s_6 \end{pmatrix}$$

$$\begin{aligned} \xrightarrow{\gamma_2} & \begin{pmatrix} E \\ s_4 \end{pmatrix} \xrightarrow{*} \begin{pmatrix} E \\ s_5 \end{pmatrix} \\ \xrightarrow{\gamma_1^{-1}} & \begin{pmatrix} B \\ s_1 \end{pmatrix} \xrightarrow{*} \begin{pmatrix} B \\ s_2 \end{pmatrix} \\ \xrightarrow{\gamma_3^{-1}} & \begin{pmatrix} D \\ s_3 \end{pmatrix} \xrightarrow{*} \begin{pmatrix} D \\ s_4 \end{pmatrix} \\ \xrightarrow{\gamma_2^{-1}} & \begin{pmatrix} A \\ s_6 \end{pmatrix} \xrightarrow{*} \begin{pmatrix} A \\ s_1 \end{pmatrix}. \end{aligned}$$

Thus we have the elliptic cycle $A \rightarrow F \rightarrow E \rightarrow B \rightarrow D$ with associated elliptic cycle transformation $\gamma_2^{-1}\gamma_3^{-1}\gamma_1^{-1}\gamma_2\gamma_1$. However, the vertex C is not part of this elliptic cycle and so must be part of another elliptic cycle:

$$\begin{pmatrix} C \\ s_3 \end{pmatrix} \xrightarrow{\gamma_3} \begin{pmatrix} C \\ s_2 \end{pmatrix} \xrightarrow{*} \begin{pmatrix} C \\ s_3 \end{pmatrix}.$$

Thus we have another elliptic cycle C with associated elliptic cycle transformation γ_3 .

Definition. Let v be a vertex of the hyperbolic polygon D . We denote the elliptic cycle transformation associated to the vertex v and the side s by $\gamma_{v,s}$.

Remarks.

1. Suppose instead that we had started at $(v, *s)$ instead of (v, s) . The procedure above gives an elliptic cycle transformation $\gamma_{v,*s}$. One can easily check that $\gamma_{v,*s} = \gamma_{v,s}^{-1}$.
2. Suppose instead that we had started at $(v_i, *s_i)$ instead of (v_0, s_0) . Then we would have obtained the elliptic cycle transformation

$$\gamma_{v_i,*s_i} = \gamma_i\gamma_{i-1} \cdots \gamma_1\gamma_n \cdots \gamma_{i+2}\gamma_{i+1},$$

i.e. a cyclic permutation of the maps involved in defining the elliptic cycle transformation associated to (v_0, s_0) . Moreover, it is easy to see that

$$\gamma_{v_i,*s_i} = (\gamma_i \cdots \gamma_1)\gamma_{v_0,s_0}(\gamma_i \cdots \gamma_1)^{-1}$$

so that $\gamma_{v_i,*s_i}$ and γ_{v_0,s_0} are conjugate Möbius transformations.

Exercise 17.1

Convince yourself that the above two claims are true.

Let v be a vertex of D with associated elliptic cycle transformation $\gamma_{v,s}$. Then $\gamma_{v,s}$ is a Möbius transformation fixing the vertex v . In Lecture 9 we saw that if a Möbius transformation has a fixed point in \mathbb{H} then it must be either elliptic or the identity. Thus each elliptic cycle transformation is either an elliptic Möbius transformation or the identity.

Definition. If an elliptic cycle transformation is the identity then we call the elliptic cycle an *accidental cycle*.

§17.2 The order of an elliptic cycle

Definition. Let $\gamma \in \text{Möb}(\mathbb{H})$ be a Möbius transformation. We say that γ has *finite order* if there exists an integer $m > 0$ such that $\gamma^m = \text{Id}$. We call the least such integer $m > 0$ the *order* of γ .

Example. Working in \mathbb{D} , the rotation $\gamma(z) = e^{2\pi i\theta}z$ has finite order if and only if $\theta = p/q$, a rational.

More generally, if γ is conjugate to a rotation through a rational multiple of 2π then γ has finite order. Indeed, this is the only way in which elements of finite order can arise. Thus, if γ has finite order then γ must be elliptic. For elements of a Fuchsian group, the converse is also true: elliptic elements must also be of finite order (and therefore conjugate to a rotation through a rational multiple of 2π).

Proposition 17.2.1

Let Γ be a Fuchsian group and let $\gamma \in \Gamma$ be an elliptic element. Then there exists an integer $m \geq 1$ such that $\gamma^m = \text{Id}$.

Proof (sketch). Recall that an elliptic Möbius transformation γ is conjugate to a rotation, say through angle $2\pi\theta$ where $\theta \in [0, 1]$. Consider the elements $\gamma^n \in \Gamma$; these are conjugate to rotations through angle $2\pi n\theta \bmod 1$ (that is, we take $n\theta$ and ignore the integer part). The proposition follows from the following (fairly easily proved) fact: the sequence $n\theta \bmod 1$ is a discrete subset of $[0, 1]$ if and only if θ is rational, say $\theta = k/m$. As Γ is a Fuchsian group, the subgroup $\{\gamma^n \mid n \in \mathbb{Z}\}$ is also a Fuchsian group, and therefore discrete. Hence γ is conjugate to a rotation by $2k\pi/m$. Hence γ^m is conjugate to a rotation through $2k\pi$, i.e. γ^m is the identity. \square

Let Γ be a Fuchsian group with Dirichlet polygon D . Let v be a vertex of D with elliptic cycle transformation $\gamma_{v,s} \in \Gamma$. Then by Proposition 17.2.1, there exists an integer $m \geq 1$ such that $\gamma_{v,s}^m = \text{Id}$. The *order* of $\gamma_{v,s}$ is the least such integer m .

Exercise 17.2

(i) Show that $\gamma_{v_0,s_0}, \gamma_{v_i,s_i}$ have the same order.

(ii) Show that if γ has order m then so does γ^{-1} .

It follows from Exercise 17.2 that the order does not depend on which vertex we choose in an elliptic cycle, nor does it depend on whether we start at (v, s) or $(v, *s)$. Hence for an elliptic cycle \mathcal{E} we write $m_{\mathcal{E}}$ for the order of $\gamma_{v,s}$ where v is some vertex on the elliptic cycle \mathcal{E} and s is a side with an endpoint at v . We call $m_{\mathcal{E}}$ the *order of \mathcal{E}* .

§17.3 Angle sum

Let $\angle v$ denote the internal angle of D at the vertex v . Consider the elliptic cycle $\mathcal{E} = v_0 \rightarrow v_1 \rightarrow \cdots \rightarrow v_{n-1}$ of the vertex $v = v_0$. We define the *angle sum* to be

$$\text{sum}(\mathcal{E}) = \angle v_0 + \cdots + \angle v_{n-1}.$$

Clearly, the angle sum of an elliptic cycle does not depend on which vertex we start at. Hence we can write $\text{sum}(\mathcal{E})$ for the angle sum along an elliptic cycle.

Proposition 17.3.1

Let Γ be a Fuchsian group with Dirichlet polygon D with all vertices in \mathbb{H} and let \mathcal{E} be an elliptic cycle. Then there exists an integer $m_{\mathcal{E}} \geq 1$ such that

$$m_{\mathcal{E}} \text{sum}(\mathcal{E}) = 2\pi.$$

Moreover, $m_{\mathcal{E}}$ is the order of \mathcal{E} .

Proof. See Katok. □

Remark. Recall that we say that an elliptic cycle \mathcal{E} is accidental if the associated elliptic cycle transformation is the identity. Clearly the identity has order 1. Hence if \mathcal{E} is an accidental cycle then it has order $m_{\mathcal{E}} = 1$ and $\text{sum}(\mathcal{E}) = 2\pi$.

18. Generators and relations

§18.1 Generators and relations

Generators and relations provide a useful and widespread method for describing a group. Although generators and relations can be set up formally, we prefer for simplicity to take a more heuristic approach here.

§18.2 Generators of a group

Definition. Let Γ be a group. We say that a subset $S = \{\gamma_1, \dots, \gamma_n\} \subset \Gamma$ is a *set of generators* if every element of Γ can be written as a composition of elements from S and their inverses. We write $\Gamma = \langle S \rangle$.

Examples.

1. Consider the additive group \mathbb{Z} . Then \mathbb{Z} is generated by the element 1: then every positive element $n > 0$ of \mathbb{Z} can be written as $1 + \dots + 1$ (n times), and every negative element $-n, n > 0$ of \mathbb{Z} can be written $(-1) + \dots + (-1)$ (n times).
2. The additive group $\mathbb{Z}^2 = \{(n, m) \mid n, m \in \mathbb{Z}\}$ is generated by $\{(1, 0), (0, 1)\}$.
3. The multiplicative group of p th roots of unity $\{1, \omega, \dots, \omega^{p-1}\}$, $\omega = e^{2\pi i/p}$, is generated by ω .

Remark. A given group Γ will, in general, have many different generating sets. For example, the set $\{2, 3\}$ generates the additive group of integers. (To see this, note that $1 = 3 - 2$ hence $n = 3 + \dots + 3 + (-2) + \dots + (-2)$ where there are n 3s and n -2s.)

§18.3 The side-pairing transformations generate a Fuchsian group

Let Γ be a Fuchsian group and let $D(p)$ be a Dirichlet polygon for Γ . In Lecture 17 we saw how to associate to $D(p)$ a set of side-pairing transformations. The importance of side-pairing transformations comes from the following result.

Theorem 18.3.1

Let Γ be a Fuchsian group. Suppose that $D(p)$ is a Dirichlet polygon with $\text{Area}_{\mathbb{H}}(D(p)) < \infty$. Then the set of side-pairing transformations of $D(p)$ generate Γ .

Proof. See Katok's book. □

Example. Consider the modular group $\Gamma = \text{PSL}(2, \mathbb{Z})$. We have seen that a fundamental domain for Γ is given by the set $D(p) = \{z \in \mathbb{H} \mid -1/2 < \text{Re}(z) < 1/2, |z| > 1\}$, where $p = ki$ for any $k > 1$. We saw in Lecture 17 that the side-pairing transformations are $z \mapsto z + 1$ (and its inverse $z \mapsto z - 1$) and $z \mapsto -1/z$. It follows from Theorem 18.3.1 that the modular group $\text{PSL}(2, \mathbb{Z})$ is generated by the transformations $z \mapsto z + 1$ and $z \mapsto -1/z$. We write $\text{PSL}(2, \mathbb{Z}) = \langle z \mapsto z + 1, z \mapsto -1/z \rangle$.

§18.4 Groups abstractly defined in terms of generators and relations

In the above, we started with a group and looked for generators. Alternatively, one could start with an abstract set of generators and a set of relationships between them, and use this information to describe a group.

§18.5 Free groups

Let S be a finite set of k symbols. If $a \in S$ is a symbol then we introduce another symbol a^{-1} and denote the set of such symbols by S^{-1} .

We look at all finite concatenations of symbols chosen from $S \cup S^{-1}$, subject to the condition that concatenations of the form aa^{-1} and $a^{-1}a$ are removed. Such a finite concatenation of n symbols is called a *word of length n* . Let

$$\begin{aligned}\mathcal{W}_n &= \{\text{all words of length } n\} \\ &= \{w_n = a_1 \cdots a_n \mid a_j \in S \cup S^{-1}, a_{j\pm 1} \neq a_j^{-1}\}.\end{aligned}$$

We let e denote the empty word (the word consisting of no symbols) and, for consistency, let $\mathcal{W}_0 = \{e\}$.

If w_n and w_m are words then we can form a new word $w_n w_m$ of length at most $n + m$ by concatenation: if $w_n = a_1 \cdots a_n$ and $w_m = b_1 \cdots b_m$ then

$$w_n w_m = a_1 \cdots a_n b_1 \cdots b_m.$$

If $b_1 = a_n^{-1}$ then we delete the term $a_n b_1$ from this product (and then we have to see if $b_2 = a_{n-1}^{-1}$; if so, then we delete the term $a_{n-1} b_2$, etc).

Definition. Let S be a finite set of k elements. We define

$$\mathcal{F}_k = \bigcup_{n \geq 0} \mathcal{W}_n,$$

the collection of all finite words (subject to the condition that symbol a never follows or is followed by a^{-1}), to be the *free group on k generators*.

Let us check that this is a group where the group operation is concatenation of words.

- (i) The group operation is well-defined: as we saw above, the concatenation of two words is another word.
- (ii) Concatenation is associative (intuitively this is clear, but it is surprisingly difficult to prove rigorously).
- (iv) Existence of an identity: the empty word e (the word consisting of no symbols) is the identity element; if $w = a_1 \cdots a_n \in \mathcal{F}_n$ then $we = ew = w$.
- (iii) Existence of inverses: if $w = a_1 \cdots a_n$ is a word then the word $w^{-1} = a_n^{-1} \cdots a_1^{-1}$ is such that $ww^{-1} = w^{-1}w = e$.

§18.6 Generators and relations

We call \mathcal{F}_k a *free* group because the group product is free: there is no cancellation between any of the symbols (other than the necessary condition that $aa^{-1} = a^{-1}a = e$ for each symbol $a \in S$). We can obtain a wide range of groups by introducing relations. A *relation* is a word that we declare to be equal to the identity. When writing a group element as a concatenation of symbols then we are allowed to cancel any occurrences of the relations.

Definition. Let $S = \{a_1, \dots, a_k\}$ be a finite set of symbols and let w_1, \dots, w_m be a finite set of words. We define the group

$$\Gamma = \langle a_1, \dots, a_k \mid w_1 = \dots = w_m = e \rangle \quad (18.6.1)$$

to be the set of all words of symbols from $S \cup S^{-1}$, subject to the conditions that (i) any subwords of the form aa^{-1} or $a^{-1}a$ are deleted, and (ii) any occurrences of the subwords w_1, \dots, w_m are deleted. Thus any occurrences of the words w_1, \dots, w_m can be replaced by the empty word e , i.e. the group identity. We call the above group Γ the *group with generators a_1, \dots, a_k and relations w_1, \dots, w_m* .

It is an important and interesting question to ask when a given group can be written in the above form.

Definition. We say that a group Γ is *finitely presented* if it can be written in the above form, with finitely many generators and finitely many relations. We call an expression of the form (18.6.1) a *presentation* of Γ .

Examples.

- (i) Trivially, the free group on k generators is finitely presented (there are no relations).
- (ii) Let $\omega = e^{2\pi i/p}$. The group $\Gamma = \{1, \omega, \omega^2, \dots, \omega^{p-1}\}$ of p^{th} roots of unity is finitely presented. Using the group isomorphism $\omega \mapsto a$, we can write it in the form

$$\langle a \mid a^p = e \rangle.$$

- (iii) The (additive) group \mathbb{Z} of integers is finitely presented. Indeed, it is the free group on 1 generator:

$$\langle a \rangle = \{a^n \mid n \in \mathbb{Z}\}.$$

Notice that $a^{n+m} = a^n a^m$, so that $\langle a \rangle$ is isomorphic to \mathbb{Z} under the isomorphism $a^n \mapsto n$.

- (iv) The (additive, abelian) group $\mathbb{Z}^2 = \{(n, m) \mid n, m \in \mathbb{Z}\}$ is finitely presented. This is because it is isomorphic to

$$\Gamma = \langle a, b \mid a^{-1}b^{-1}ab = e \rangle.$$

If we take a word in the free group $\langle a, b \rangle$ on 2 generators, then it will be of the form

$$a^{n_1} b^{m_1} a^{n_2} \dots a^{n_\ell} b^{m_\ell}.$$

In particular, the free group $\langle a, b \rangle$ is not abelian because $ab \neq ba$. However, adding the relation $a^{-1}b^{-1}ab$ allows us to make the group abelian. To see this, note that

$$\begin{aligned} ba &= ba e &= ba(a^{-1}b^{-1}ab) \\ &= b(aa^{-1})b^{-1}ab \\ &= beb^{-1}ab \\ &= bb^{-1}ab \\ &= ab. \end{aligned}$$

Thus, in the group $\langle a, b \mid a^{-1}b^{-1}ab = e \rangle$ we can use the relation $a^{-1}b^{-1}ab$ to write the word

$$a^{n_1}b^{m_1}a^{n_2} \dots a^{n_\ell}b^{m_\ell}.$$

as

$$a^{n_1+\dots+n_\ell}b^{m_1+\dots+m_\ell}.$$

Hence

$$\langle a, b \mid a^{-1}b^{-1}ab = e \rangle = \{a^n b^m \mid n, m \in \mathbb{Z}\}$$

which, using the group isomorphism $(n, m) \mapsto a^n b^m$, is seen to be isomorphic to \mathbb{Z}^2 .

(v) Consider the group

$$\langle a, b \mid a^4 = b^2 = (ab)^2 = e \rangle.$$

One can easily check that there are exactly 8 elements in this group, namely:

$$e, a, a^2, a^3, b, ab, a^2b, a^3b.$$

This is the symmetry group of a square (it is also called the dihedral group). The element a corresponds to an anti-clockwise rotation through a right-angle; the element b corresponds to reflection in a diagonal.

(vi) We shall see in Lecture 19 that the group

$$\langle a, b \mid a^2 = (ab)^3 = e \rangle$$

is isomorphic to the modular group $\text{PSL}(2, \mathbb{Z})$. The symbol a corresponds to the Möbius transformation $z \mapsto -1/z$; the symbol b corresponds to the Möbius transformation $z \mapsto z + 1$.

Exercise 18.1

Check the assertion in example (v) above, i.e. show that if $\Gamma = \langle a, b \mid a^4 = b^2 = (ab)^2 = e \rangle$ then Γ contains exactly 8 elements.

In the above, the group in example (v) is finite and one can easily write down all of the elements in the group. However, the group $\langle a, b \mid a^5 = b^3 = (ab)^2 = e \rangle$ has 60 elements and it is not at all easy to write down all 60 elements. More generally, there are many important and open questions about writing a group in terms of a finite set of generators and relations. For example:

- (i) Let Γ be a countable group (that is, a group with countably many elements). Is it possible to decide if Γ is finitely presented?

- (ii) Suppose that Γ is finitely presented. Is it possible to decide if Γ is a finite group?
- (iii) Given two sets of generators and relations, is it possible to decide if the two groups are isomorphic?
- (iv) Suppose that Γ is finitely presented and H is a subgroup of Γ . When is it true that H is finitely presented?

Questions like these are typically extremely hard to answer and require techniques from logic and computer science to be able to answer; often the answer is that the problem is ‘undecidable’!

19. Poincaré's Theorem: the case of no boundary vertices

§19.1 Poincaré's Theorem

In Lectures 14–16 we started with a Fuchsian group and then constructed a Dirichlet polygon and a set of side-pairing transformations. Here we study the reverse. Namely, we start with a convex hyperbolic polygon and a set of side-pairing transformations and ask: when do these side-pairing transformations generate a Fuchsian group? In general, the group generated will not be discrete and so will not be a Fuchsian group. However, under natural conditions, the group will be discrete. This is Poincaré's theorem.

Let D be a convex hyperbolic polygon. In this lecture we shall assume that all the vertices of D are in \mathbb{H} , that is, there are no vertices on the boundary $\partial\mathbb{H}$. We assume that D is equipped with a set of side-pairing transformations. That is, to each side s , we have a Möbius transformation γ_s associated to s such that $\gamma_s(s) = s'$, another side of D . We will also require the isometry γ_s to act in such a way that, locally, the half-plane bounded by s containing D is mapped by γ_s to the half-plane bounded by $\gamma_s(s)$ but opposite D . In particular, γ_s cannot be the identity.

We follow the procedure in Lecture 17 to construct elliptic cycles, namely:

- (i) Let $v = v_0$ be a vertex of D and let s_0 be a side with an endpoint at v_0 . Let γ_1 be the side-pairing transformation associated to the side s_0 . Thus γ_1 maps s_0 to another side s_1 of D .
- (ii) Let $s_1 = \gamma_1(s_0)$ and let $v_1 = \gamma_1(v_0)$. This gives a new pair (v_1, s_1) .
- (iii) Now consider the pair $*(v_1, s_1)$. This is the pair consisting of the vertex v_1 and the side $*s_1$ (i.e. the side of D other than s_1 with an endpoint of v_1).
- (iv) Let γ_2 be the side-pairing transformation associated to the side $*s_1$. Then $\gamma_2(*s_1)$ is a side s_2 of D and $\gamma_2(v_1) = v_2$, a vertex of D .
- (v) Repeat the above inductively.

Thus we obtain a sequence of pairs of vertices and sides:

$$\begin{array}{c}
 \begin{pmatrix} v_0 \\ s_0 \end{pmatrix} \xrightarrow{\gamma_1} \begin{pmatrix} v_1 \\ s_1 \end{pmatrix} \xrightarrow{*} \begin{pmatrix} v_1 \\ *s_1 \end{pmatrix} \\
 \xrightarrow{\gamma_2} \begin{pmatrix} v_2 \\ s_2 \end{pmatrix} \xrightarrow{*} \dots \\
 \xrightarrow{\gamma_i} \begin{pmatrix} v_i \\ s_i \end{pmatrix} \xrightarrow{*} \begin{pmatrix} v_i \\ *s_i \end{pmatrix} \\
 \xrightarrow{\gamma_{i+1}} \begin{pmatrix} v_{i+1} \\ s_{i+1} \end{pmatrix} \xrightarrow{*} \dots
 \end{array}$$

Again, as there are only finitely many pairs (v, s) , this process of applying a side-pairing transformation followed by applying $*$ must eventually return to the initial pair (v_0, s_0) . Let n be the least integer $n > 0$ for which $(v_n, *s_n) = (v_0, s_0)$.

Definition. The sequence of vertices $\mathcal{E} = v_0 \rightarrow v_1 \rightarrow \cdots \rightarrow v_{n-1}$ is called an *elliptic cycle*. The transformation $\gamma_n \gamma_{n-1} \cdots \gamma_2 \gamma_1$ is called an *elliptic cycle transformation*.

Again, as there are only finitely many pairs of vertices and sides, we see that there are only finitely many elliptic cycles and elliptic cycle transformations.

Definition. Let v be a vertex of the hyperbolic polygon D and let s be a side of D with an end-point at v . We denote the elliptic cycle transformation associated to the pair (v, s) by $\gamma_{v,s}$.

Definition. Let $\angle v$ denote the internal angle of D at the vertex v . Consider the elliptic cycle $\mathcal{E} = v_0 \rightarrow v_1 \rightarrow \cdots \rightarrow v_{n-1}$ of the vertex $v = v_0$. We define the *angle sum* to be

$$\text{sum}(\mathcal{E}) = \angle v_0 + \cdots + \angle v_{n-1}.$$

Definition. We say that an elliptic cycle \mathcal{E} satisfies the *elliptic cycle condition* if there exists an integer $m \geq 1$, depending on \mathcal{E} such that

$$m \text{sum}(\mathcal{E}) = 2\pi.$$

Remark. Observe that if one vertex on a vertex cycle satisfies the elliptic cycle condition, then so does any other vertex on that vertex cycle. Thus it makes sense to say that an elliptic cycle satisfies the elliptic cycle condition.

We can now state Poincaré's Theorem. Put simply, it says that if each elliptic cycle satisfies the elliptic cycle condition then the side-pairing transformations generate a Fuchsian group. Moreover, it also tells us how to write the group in terms of generators and relations.

Theorem 19.1.1 (Poincaré's Theorem)

Let D be a convex hyperbolic polygon with finitely many sides. Suppose that all vertices lie inside \mathbb{H} and that D is equipped with a collection \mathcal{G} of side-pairing Möbius transformations. Suppose that no side of D is paired with itself.

Suppose that the elliptic cycles are $\mathcal{E}_1, \dots, \mathcal{E}_r$. Suppose that each elliptic cycle \mathcal{E}_j of D satisfies the elliptic cycle condition: for each \mathcal{E}_j there exists an integer $m_j \geq 1$ such that

$$m_j \text{sum}(\mathcal{E}_j) = 2\pi.$$

Then:

- (i) The subgroup $\Gamma = \langle \mathcal{G} \rangle$ generated by \mathcal{G} is a Fuchsian group;
- (ii) The Fuchsian group Γ has D as a fundamental domain.
- (iii) The Fuchsian group Γ can be written in terms of generators and relations as follows. For each elliptic cycle \mathcal{E}_j , choose a corresponding elliptic cycle transformation $\gamma_j = \gamma_{v,s}$ (for some vertex v on the elliptic cycle \mathcal{E}). Then Γ is isomorphic to the group with generators $\gamma_s \in \mathcal{G}$ (i.e. we take \mathcal{G} to be a set of symbols), and relations $\gamma_j^{m_j}$:

$$\Gamma = \langle \gamma_s \in \mathcal{G} \mid \gamma_1^{m_1} = \gamma_2^{m_2} = \cdots = \gamma_r^{m_r} = e \rangle.$$

Proof. See Katok or Beardon. □

Remark. The relations in (iii) appear to depend on which pair (v, s) on the elliptic cycle \mathcal{E}_j is used to define γ_j . In fact, the relation $\gamma_j^{m_j}$ is independent of the choice of (v, s) . This follows from Exercise 17.1: if v' is another vertex on the same elliptic cycle as v then $\gamma_{v',s'}$ is conjugate to either $\gamma_{v,s}$ or $\gamma_{v,s}^{-1}$.

Remark. The hypothesis that D does not have a side that is paired with itself is not a real restriction: if D has a side that is paired with itself then we can introduce another vertex on the mid-point of that side, thus dividing the side into two smaller sides which are then paired with each other.

More specifically, suppose that s is a side with side-pairing transformation γ_s that pairs s with itself. Suppose that s has end-points at the vertices v_0 and v_1 . Introduce a new vertex v_2 at the mid-point of $[v_0, v_1]$. Notice that $\gamma_s(v_2) = v_2$. We must have that $\gamma_s(v_0) = v_1$ and $\gamma_s(v_1) = v_0$ (for otherwise γ_s would fix three points in \mathbb{H} and hence would be the identity, by Corollary 9.1.2). Let s_1 be the side $[v_0, v_2]$ and let s_2 be the side $[v_2, v_1]$. Then $\gamma_s(s_1) = s_2$ and $\gamma_s(s_2) = s_1$. Hence γ_s pairs the sides s_1 and s_2 . Notice that the internal angle at the vertex v_2 is equal to π . See Figure 19.1.1.

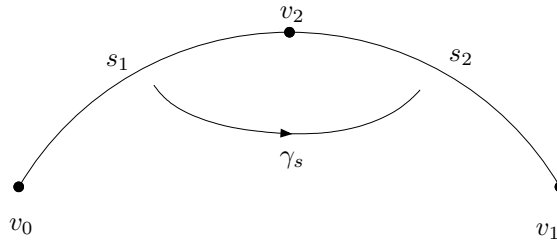

Figure 19.1.1: The side s is paired with itself; by splitting it in half, we have two distinct sides that are paired

Exercise 19.1

Take a hyperbolic quadrilateral such that each pair of opposing sides have the same length. Define two side-pairing transformation γ_1, γ_2 that pair each pair of opposite sides. See Figure 19.1.2. Show that there is only one elliptic cycle and determine the associated elliptic cycle transformation. When do γ_1 and γ_2 generate a Fuchsian group?

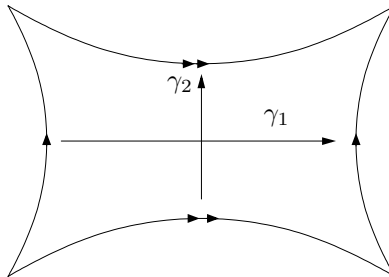

Figure 19.1.2: A hyperbolic quadrilateral with opposite sides paired

§19.2 An important example: a hyperbolic octagon

The following, as we shall see, is an important example of Poincaré's Theorem.

From Exercise 7.3 we know that there exists a regular hyperbolic octagon with each internal angle equal to $\pi/4$.

Label the vertices of such an octagon anti-clockwise v_1, \dots, v_8 and label the sides anti-clockwise s_1, \dots, s_8 so that side s_j occurs immediately after vertex v_j . See Figure 19.2.3. As P is a regular octagon, each of the sides s_j has the same length.

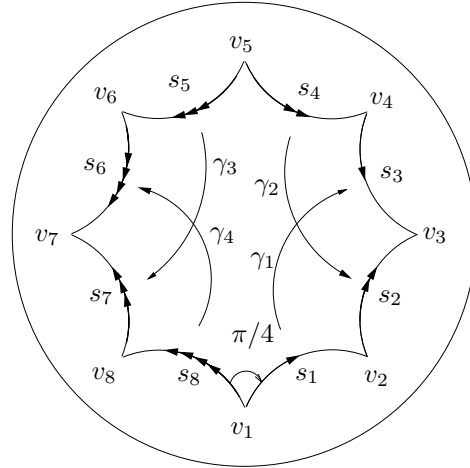

Figure 19.2.3: A regular hyperbolic octagon with internal angles $\pi/4$ and side-pairings indicated

$$\begin{array}{l}
 \begin{pmatrix} v_1 \\ s_1 \end{pmatrix} \xrightarrow{\gamma_1} \begin{pmatrix} v_4 \\ s_3 \end{pmatrix} \xrightarrow{*} \begin{pmatrix} v_4 \\ s_4 \end{pmatrix} \\
 \xrightarrow{\gamma_2} \begin{pmatrix} v_3 \\ s_2 \end{pmatrix} \xrightarrow{*} \begin{pmatrix} v_3 \\ s_3 \end{pmatrix} \\
 \xrightarrow{\gamma_1^{-1}} \begin{pmatrix} v_2 \\ s_1 \end{pmatrix} \xrightarrow{*} \begin{pmatrix} v_2 \\ s_2 \end{pmatrix} \\
 \xrightarrow{\gamma_2^{-1}} \begin{pmatrix} v_5 \\ s_4 \end{pmatrix} \xrightarrow{*} \begin{pmatrix} v_5 \\ s_5 \end{pmatrix} \\
 \xrightarrow{\gamma_3} \begin{pmatrix} v_8 \\ s_7 \end{pmatrix} \xrightarrow{*} \begin{pmatrix} v_8 \\ s_8 \end{pmatrix} \\
 \xrightarrow{\gamma_4} \begin{pmatrix} v_7 \\ s_6 \end{pmatrix} \xrightarrow{*} \begin{pmatrix} v_7 \\ s_7 \end{pmatrix} \\
 \xrightarrow{\gamma_3^{-1}} \begin{pmatrix} v_6 \\ s_5 \end{pmatrix} \xrightarrow{*} \begin{pmatrix} v_6 \\ s_6 \end{pmatrix} \\
 \xrightarrow{\gamma_4^{-1}} \begin{pmatrix} v_1 \\ s_8 \end{pmatrix} \xrightarrow{*} \begin{pmatrix} v_1 \\ s_1 \end{pmatrix}.
 \end{array}$$

Thus there is just one elliptic cycle:

$$\mathcal{E} = v_1 \rightarrow v_4 \rightarrow v_3 \rightarrow v_2 \rightarrow v_5 \rightarrow v_8 \rightarrow v_7 \rightarrow v_6.$$

with associated elliptic cycle transformation:

$$\gamma_4^{-1}\gamma_3^{-1}\gamma_4\gamma_3\gamma_2^{-1}\gamma_1^{-1}\gamma_2\gamma_1$$

As the internal angle at each vertex is $\pi/4$, the angle sum is

$$8\frac{\pi}{4} = 2\pi.$$

Hence the elliptic cycle condition holds (with $m_{\mathcal{E}} = 1$). Thus by Poincaré's Theorem, the group generated by the side-pairing transformations $\gamma_1, \dots, \gamma_4$ generate a Fuchsian group. Moreover, we can write this group in terms of generators and relations as follows:

$$\langle \gamma_1, \gamma_2, \gamma_3, \gamma_4 \mid \gamma_4^{-1}\gamma_3^{-1}\gamma_4\gamma_3\gamma_2^{-1}\gamma_1^{-1}\gamma_2\gamma_1 = e \rangle.$$

20. Poincaré's Theorem: the case of boundary vertices

§20.1 Recap

In Lecture 19 we studied groups generated by side-pairing transformations defined on a hyperbolic polygon D with no vertices on the boundary. Here we consider what happens if the hyperbolic polygon has vertices on the boundary $\partial\mathbb{H}$.

§20.2 Poincaré's Theorem in the case of boundary vertices

Recall that a convex hyperbolic polygon can be described as the intersection of a finite number of half-planes and that this definition allows the possibility that the polygon has an edge lying on the boundary. (Such edges are called *free edges*.) We will assume that this does *not* happen, i.e. all the edges of D are arcs of geodesics. See Figure 20.2.1.

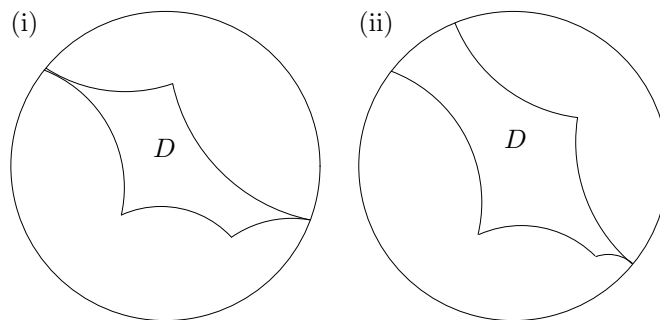

Figure 20.2.1: (i) A polygon in \mathbb{D} with no free edges, (ii) a polygon in \mathbb{D} with a free edge

Let D be a convex hyperbolic polygon with no free edges and suppose that each side s of D is equipped with a side-pairing transformation γ_s . We will also require the isometry γ_s to act in such a way that, locally, the half-plane bounded by s containing D is mapped by γ_s to the half-plane bounded by $\gamma_s(s)$ but opposite D . In particular, γ_s cannot be the identity. Notice that as Möbius transformations of \mathbb{H} act on $\partial\mathbb{H}$ and indeed map $\partial\mathbb{H}$ to itself, each side-pairing transformation maps a boundary vertex to another boundary vertex.

Let $v = v_0$ be a boundary vertex of D and let $s = s_0$ be a side with an end-point at v_0 . Then we can repeat the procedure described in Lecture 19 (using the same notation) starting at the pair (v_0, s_0) to obtain a finite sequence of boundary vertices $\mathcal{P} = v_0 \rightarrow \cdots \rightarrow v_{n-1}$ and an associated Möbius transformation $\gamma_{v,s} = \gamma_n \cdots \gamma_1$.

Definition. Let $v = v_0$ be a boundary vertex of D and let $s = s_0$ be a side with an end-point at v . We call $\mathcal{P} = v_0 \rightarrow \cdots \rightarrow v_{n-1}$ a *parabolic cycle* with associated *parabolic cycle transformation* $\gamma_{v,s} = \gamma_n \cdots \gamma_1$.

As there are only finitely many vertices and sides, there are at most finitely many parabolic cycles and parabolic cycle transformations.

Example. Consider the polygon described in Figure 20.2.2 with the side-pairings indicated. Then following the procedure as described in Lecture 19 starting at the pair (A, s_1)

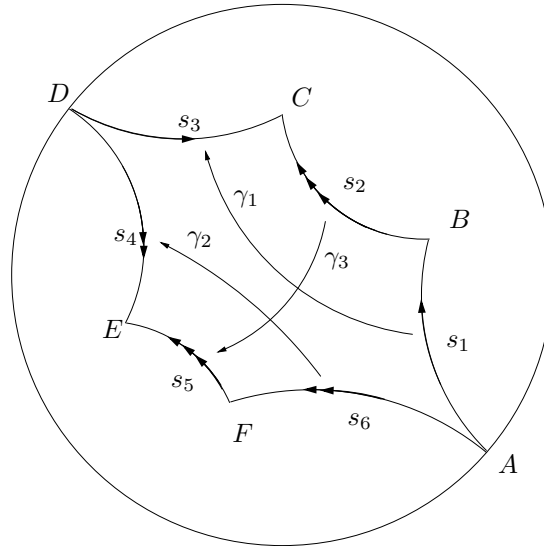

Figure 20.2.2: A polygon with 2 boundary vertices and with side-pairings indicated

we have:

$$\begin{aligned} \begin{pmatrix} A \\ s_1 \end{pmatrix} &\xrightarrow{\gamma_1} \begin{pmatrix} D \\ s_3 \end{pmatrix} \xrightarrow{*} \begin{pmatrix} D \\ s_4 \end{pmatrix} \\ &\xrightarrow{\gamma_2^{-1}} \begin{pmatrix} A \\ s_6 \end{pmatrix} \xrightarrow{*} \begin{pmatrix} A \\ s_1 \end{pmatrix}. \end{aligned}$$

Hence we have a parabolic cycle $A \rightarrow D$ with associated parabolic cycle transformation $\gamma_2^{-1}\gamma_1$.

There is also an elliptic cycle:

$$\begin{aligned} \begin{pmatrix} B \\ s_2 \end{pmatrix} &\xrightarrow{\gamma_3} \begin{pmatrix} F \\ s_5 \end{pmatrix} \xrightarrow{*} \begin{pmatrix} F \\ s_6 \end{pmatrix} \\ &\xrightarrow{\gamma_2} \begin{pmatrix} E \\ s_4 \end{pmatrix} \xrightarrow{*} \begin{pmatrix} E \\ s_5 \end{pmatrix} \\ &\xrightarrow{\gamma_3^{-1}} \begin{pmatrix} C \\ s_2 \end{pmatrix} \xrightarrow{*} \begin{pmatrix} C \\ s_3 \end{pmatrix} \\ &\xrightarrow{\gamma_1^{-1}} \begin{pmatrix} B \\ s_1 \end{pmatrix} \xrightarrow{*} \begin{pmatrix} B \\ s_2 \end{pmatrix}. \end{aligned}$$

Hence we have the elliptic cycle $B \rightarrow F \rightarrow E \rightarrow C$ with associated elliptic cycle transformation $\gamma_1^{-1}\gamma_3^{-1}\gamma_2\gamma_3$.

Remarks.

1. Suppose instead that we had started at $(v, *s)$ instead of (v, s) . Then we would have obtained the parabolic cycle transformation $\gamma_{v,s}^{-1}$.

2. Suppose instead that we had started at (v_i, s_i) instead of (v_0, s_0) . Then we would have obtained the parabolic cycle transformation

$$\gamma_{v_i, s_i} = \gamma_i \gamma_{i-1} \cdots \gamma_1 \gamma_n \cdots \gamma_{i+2} \gamma_{i+1},$$

i.e. a cyclic permutation of the maps involved in defining the parabolic cycle transformation associated to (v_0, s_0) . Moreover, it is easy to see that

$$\gamma_{v_i, s_i} = (\gamma_i \cdots \gamma_1) \gamma_{v_0, s_0} (\gamma_i \cdots \gamma_1)^{-1}$$

so that γ_{v_i, s_i} and γ_{v_0, s_0} are conjugate Möbius transformations.

Let v be a boundary vertex of D and let s be a side with an end-point at v . The associated parabolic cycle transformation is denoted by $\gamma_{v, s}$. Observe that $\gamma_{v, s}$ is a Möbius transformation with a fixed point at the vertex $v \in \partial\mathbb{H}$. In Lecture 9 we saw that if a Möbius transformation has at least one fixed point in $\partial\mathbb{H}$ then it must be either parabolic, hyperbolic or the identity. Thus each parabolic cycle transformation is either a parabolic or hyperbolic Möbius transformation or the identity.

Definition. We say that a parabolic cycle \mathcal{P} satisfies the *parabolic cycle condition* if for some (hence all) vertex $v \in \mathcal{P}$, the parabolic cycle transformation $\gamma_{v, s}$ is either a parabolic Möbius transformation or the identity

Remark. Let $\gamma \in \text{Möb}(\mathbb{H}) \setminus \{\text{id}\}$. Recall that γ is parabolic if and only if the trace, $\tau(\gamma)$, is 4. Also note that if $\gamma = \text{id}$ then $\tau(\gamma) = 4$. Hence a parabolic cycle \mathcal{P} satisfies the parabolic cycle condition if for some (hence all) vertex $v \in \mathcal{P}$, the parabolic cycle transformation $\gamma_{v, s}$ has $\tau(\gamma_{v, s}) = 4$.

Remark. Observe that γ_{v_0, s_0} is parabolic (or the identity) if and only if γ_{v_i, s_i} is parabolic (or the identity) for any other vertex v_i on the parabolic cycle containing v_0 . Also observe that $\gamma_{v, s}$ is parabolic (or the identity) if and only if $\gamma_{v, *s}$ is parabolic (or the identity). Thus it makes sense to say that a parabolic cycle \mathcal{P} satisfies the parabolic cycle condition.

We can now state Poincaré's Theorem in the case when D has boundary vertices (but no free edges).

Theorem 20.2.1 (Poincaré's Theorem)

Let D be a convex hyperbolic polygon with finitely many sides, possibly with boundary vertices (but with no free edges). Suppose that D is equipped with a collection \mathcal{G} of side-pairing Möbius transformations such that no side is paired with itself.

Let the elliptic cycles be $\mathcal{E}_1, \dots, \mathcal{E}_r$ and let the parabolic cycles be $\mathcal{P}_1, \dots, \mathcal{P}_s$. Suppose that:

- (i) each elliptic cycle \mathcal{E}_j satisfies the elliptic cycle condition, and
- (ii) each parabolic cycle \mathcal{P}_j satisfies the parabolic cycle condition.

Then:

- (i) The subgroup $\Gamma = \langle \mathcal{G} \rangle$ generated by \mathcal{G} is a Fuchsian group,
- (ii) The Fuchsian group Γ has D as a fundamental domain.

(iii) The Fuchsian group Γ can be written in terms of generators and relations as follows. For each elliptic cycle \mathcal{E}_j , choose a corresponding elliptic cycle transformation $\gamma_j = \gamma_{v,s}$ (for some vertex v on the elliptic cycle \mathcal{E}_j). Then Γ is isomorphic to the group with generators $\gamma_s \in \mathcal{G}$ (i.e. we take \mathcal{G} to be a set of symbols), and relations $\gamma_j^{m_j}$, where $m_j \text{ sum } \mathcal{E}_j = 2\pi$:

$$\Gamma = \langle \gamma_s \in \mathcal{G} \mid \gamma_1^{m_1} = \dots = \gamma_r^{m_r} = e \rangle.$$

Remark. The hypothesis that D does not have a side that is paired with itself is not a real restriction: if D has a side that is paired with itself then we can introduce another vertex on the mid-point of that side, thus dividing the side into two smaller sides which are then paired with each other. See Lecture 19.

§20.3 An example of Poincaré’s Theorem: the modular group

We can use the version of Poincaré’s Theorem stated in Theorem 20.2.1 to check that the modular group $\text{PSL}(2, \mathbb{Z})$ is a Fuchsian group, and to write it in terms of generators and relations.

Consider the polygon in Figure 20.3.3; here $A = (-1 + i\sqrt{3})/2$ and $B = (1 + i\sqrt{3})/2$. The side pairing transformations are given by $\gamma_1(z) = z + 1$ and $\gamma_2(z) = -1/z$. Notice that $\gamma_2(A) = B$ and $\gamma_2(B) = A$.

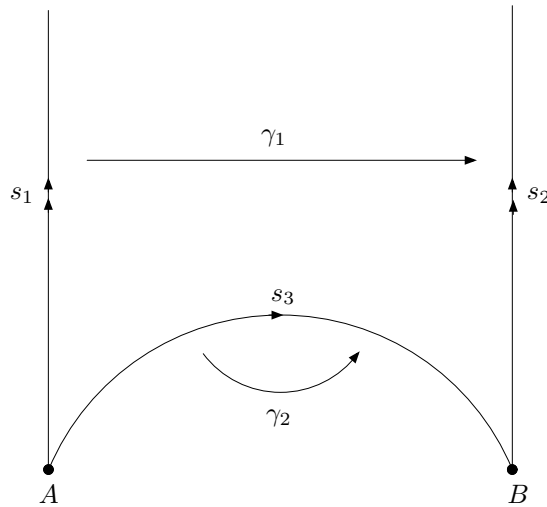

Figure 20.3.3: Side pairing transformations for the modular group

The side $[A, B]$ is paired with itself. We need to introduce an extra vertex C at the mid-point of $[A, B]$; see the discussion in Lecture 19. This is illustrated in Figure 20.3.4.

We calculate the elliptic cycles. We first calculate the elliptic cycle containing the vertex A :

$$\begin{aligned} \begin{pmatrix} A \\ s_1 \end{pmatrix} &\xrightarrow{\gamma_1} \begin{pmatrix} B \\ s_2 \end{pmatrix} \xrightarrow{*} \begin{pmatrix} B \\ s_4 \end{pmatrix} \\ &\xrightarrow{\gamma_2^{-1}} \begin{pmatrix} A \\ s_3 \end{pmatrix} \xrightarrow{*} \begin{pmatrix} A \\ s_1 \end{pmatrix}. \end{aligned}$$

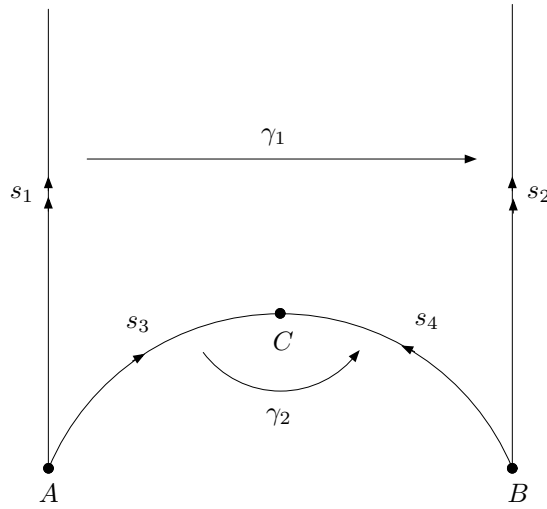

Figure 20.3.4: Introduce an extra vertex at C so that the side s_3 is paired with the side s_4

Hence $A \rightarrow B$ is an elliptic cycle which has elliptic cycle transformation $\gamma_2^{-1}\gamma_1(z) = (-z - 1)/z$. The angle sum of this elliptic cycle satisfies

$$3(\angle A + \angle B) = 3(\pi/3 + \pi/3) = 2\pi.$$

Hence the elliptic cycle condition holds.

Now calculate the elliptic cycle containing the vertex C :

$$\begin{pmatrix} C \\ s_3 \end{pmatrix} \xrightarrow{\gamma_2} \begin{pmatrix} C \\ s_4 \end{pmatrix} \xrightarrow{*} \begin{pmatrix} C \\ s_3 \end{pmatrix}.$$

Hence we have an elliptic cycle C with elliptic cycle transformation γ_2 . The angle sum of this elliptic cycle satisfies

$$2\angle C = 2\pi.$$

Hence the elliptic cycle condition holds.

We now calculate the parabolic cycles. There is just one parabolic cycle, the cycle that contains the vertex ∞ . We have

$$\begin{pmatrix} \infty \\ s_1 \end{pmatrix} \xrightarrow{\gamma_1} \begin{pmatrix} \infty \\ s_2 \end{pmatrix} \xrightarrow{*} \begin{pmatrix} \infty \\ s_1 \end{pmatrix},$$

so that we have a parabolic cycle ∞ with parabolic cycle transformation $\gamma_1(z) = z + 1$. As γ_1 has a single fixed point at ∞ it is parabolic. Hence the parabolic cycle condition holds.

By Poincaré's Theorem, we see that the group generated by γ_1 and γ_2 is a Fuchsian group. Let $a = \gamma_1$, $b = \gamma_2$. Then we can use Poincaré's Theorem to write the group generated by γ_1, γ_2 in terms of generators and relations, as follows:

$$\text{PSL}(2, \mathbb{Z}) = \langle a, b \mid (b^{-1}a)^3 = b^2 = e \rangle.$$

Remark. The above example illustrates why we need to assume that D does not have any sides that are paired with themselves. If we had not introduced the vertex C , then we would not have got the relation $b^2 = e$.

Exercise 20.1

Consider the polygon in Figure 20.3.5. The side-pairing transformations are:

$$\gamma_1(z) = z + 2, \quad \gamma_2(z) = \frac{z}{2z + 1}.$$

What are the elliptic cycles? What are the parabolic cycles? Use Poincaré's Theorem to show that the group generated by γ_1, γ_2 is a Fuchsian group and has the polygon in Figure 20.3.5 as a fundamental domain. Use Poincaré's Theorem to show that the group generated by γ_1, γ_2 is the free group on 2 generators.

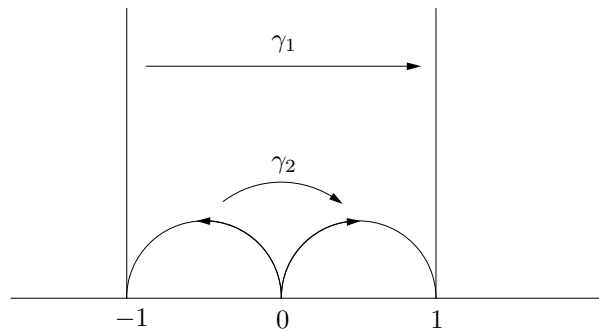

Figure 20.3.5: A fundamental domain for the free group on 2 generators

Exercise 20.2

Consider the hyperbolic quadrilateral with vertices

$$A = -\left(1 + \frac{\sqrt{2}}{2}\right), \quad B = i\frac{\sqrt{2}}{2}, \quad C = \left(1 + \frac{\sqrt{2}}{2}\right), \quad \text{and } \infty$$

and a right-angle at B , as illustrated in Figure 20.3.6.

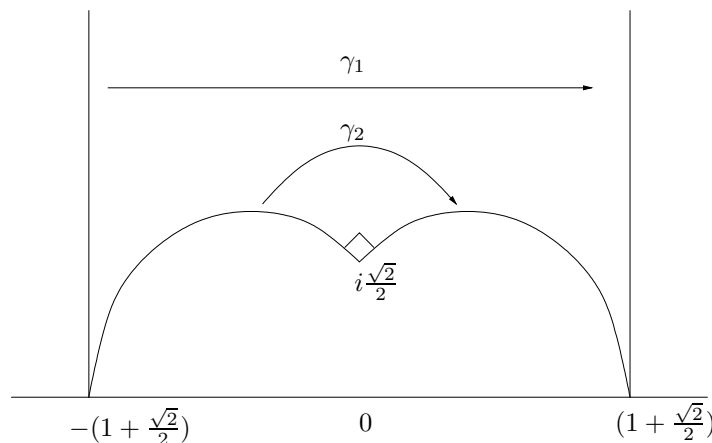

Figure 20.3.6: A hyperbolic quadrilateral

- (i) Verify that the following Möbius transformations of \mathbb{H} are side-pairing transformations:

$$\gamma_1(z) = z + 2 + \sqrt{2}, \quad \gamma_2(z) = \frac{\frac{\sqrt{2}}{2}z - \frac{1}{2}}{z + \frac{\sqrt{2}}{2}}.$$

- (ii) By using Poincaré's Theorem, show that these side-pairing transformations generate a Fuchsian group. Give a presentation of Γ in terms of generators and relations.

21. The signature of a Fuchsian group

§21.1 Introduction

Let Γ be a Fuchsian group and let $D(p)$ be a Dirichlet polygon and suppose that $\text{Area}_{\mathbb{H}}(D) < \infty$. We equip D with a set of side-pairing transformations, subject to the condition that a side is not paired with itself. We can construct a space \mathbb{H}/Γ by gluing together the sides that are paired by side-pairing transformations. This space is variously called a *quotient space*, an *identification space* or an *orbifold*.

Before giving some hyperbolic examples, let us give a Euclidean example. Consider the square in Figure 21.1.1(i) with the sides paired as indicated. We first glue together the horizontal sides to give a cylinder; then we glue the vertical sides to give a torus. See Figure 21.1.1(ii).

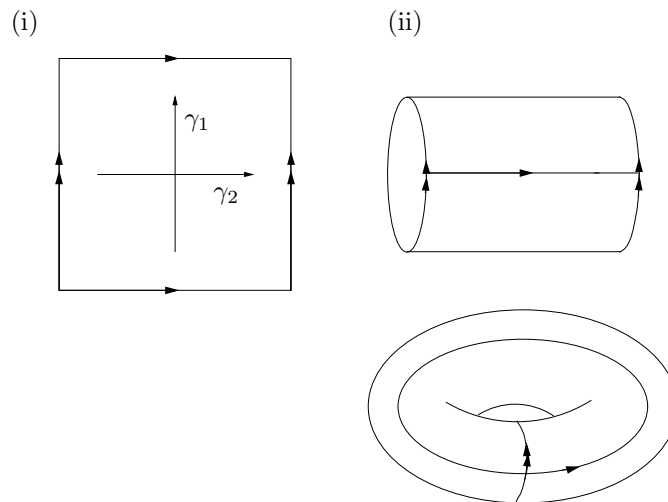

Figure 21.1.1: (i) A square with horizontal and vertical sides paired as marked, and (ii) the results of gluing first the horizontal and then the vertical sides together

In the above Euclidean example, the angles at the vertices of D glued together nicely (in the sense that they glued together to form total angle 2π) and we obtained a surface. For a general Fuchsian group the situation is slightly more complicated due to the possible presence of cusps and marked points.

Consider a Fuchsian group Γ with Dirichlet polygon D . Let us describe how one constructs the space \mathbb{H}/Γ .

Let \mathcal{E} be an elliptic cycle in D . All the vertices on this elliptic are glued together. The angles at these vertices are glued together to give total angle $\text{sum}(\mathcal{E})$. This may or may not be equal to 2π . The angle sum is equal to 2π if and only if the elliptic cycle \mathcal{E} is an accidental cycle. (Recall that an elliptic cycle is said to be *accidental* if the elliptic

cycle transformation is equal to the identity; equivalently in the elliptic cycle condition $m\text{sum}(\mathcal{E}) = 2\pi$ we have $m = 1$.)

Definition. Let \mathcal{E} be an elliptic cycle and suppose that $\text{sum}(\mathcal{E}) \neq 2\pi$. Then the vertices on this elliptic cycle are glued together to give a point on \mathbb{H}/Γ with total angle less than 2π . This point is called a *marked point*.

A marked point on \mathbb{H}/Γ is a point where the total angle is less than 2π . Thus they look like ‘kinks’ in the surface \mathbb{H}/Γ .

Definition. It follows from Proposition 17.3.1 that there exists an integer $m_{\mathcal{E}}$ such that $m_{\mathcal{E}}\text{sum}(\mathcal{E}) = 2\pi$. We call $m_{\mathcal{E}}$ the *order* of the corresponding marked point.

Now let \mathcal{P} be a parabolic cycle. Vertices along a parabolic cycle are glued together. Each parabolic cycle gives rise to a *cusps* on \mathbb{H}/Γ . These look like ‘funnels’ that go off to infinity.

Topologically, the space \mathbb{H}/Γ is determined by its genus (the number of ‘holes’) and the numbers of cusps.

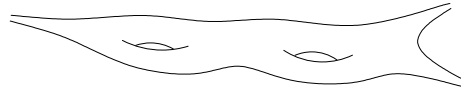

Figure 21.1.2: A hyperbolic surface of genus 2 with 3 cusps

If there are no marked points, then we call \mathbb{H}/Γ a *hyperbolic surface*.

For example, consider the Fuchsian group Γ generated by the hyperbolic octagon described in Lecture 19. The octagon D in Lecture 19 is a fundamental domain for Γ . If we glue the edges of D together according to the indicated side-pairings then we obtain a hyperbolic surface \mathbb{H}/Γ . Notice that there is just one elliptic cycle \mathcal{E} and that $\text{sum}(\mathcal{E}) = 2\pi$. This surface is a torus of genus 2, i.e. a torus with two holes. See Figure 21.1.3.

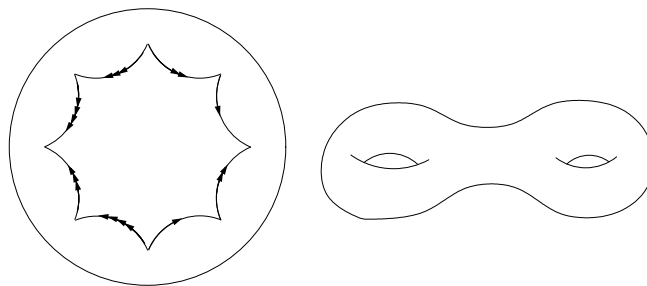

Figure 21.1.3: Gluing together the sides of D gives a torus of genus 2

§21.2 The genus and Euler characteristic

Given a 2-dimensional space X , one of the most important topological invariants that we can associate to X is its *Euler characteristic* $\chi(X)$. Let us recall how one calculates the Euler characteristic.

Definition. Let X be a 2-dimensional space. Then X can be triangulated into finitely many polygons. Suppose that in this triangulation we have V vertices, E edges and F faces (i.e. the number of polygons). Then the Euler characteristic is given by

$$\chi(X) = V - E + F.$$

Examples.

- (i) Consider the triangulation of the space illustrated in Figure 21.2.4; this is formed by gluing eight triangles together. This space is homeomorphic (meaning: topologically the same as) to the surface of a sphere. There are $V = 6$ vertices, $E = 12$ edges and $F = 8$ faces. Hence the Euler characteristic is $\chi = 6 - 12 + 8 = 2$.
- (ii) Consider the triangulation of a torus illustrated in Figure 21.2.5. There is just one polygon (so $F = 1$) and just one vertex (so $V = 1$). There are two edges, so $E = 2$. Hence $\chi = 0$.

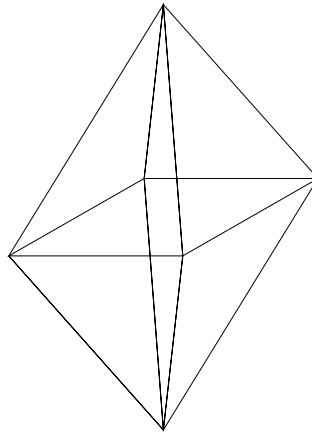

Figure 21.2.4: A triangulation of the surface of a sphere; here $V = 6, E = 12, F = 8$, so that $\chi = 2$

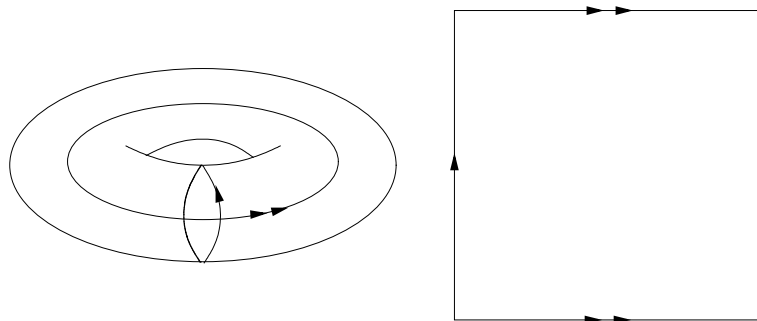

Figure 21.2.5: A triangulation of the surface of a torus; here $V = 1, E = 2, F = 1$, so that $\chi = 0$

Definition. Let X be a 2-dimensional surface. The *genus* g of X is given by

$$\chi(X) = 2 - 2g.$$

Thus, a sphere has genus 0 and a torus has genus 1. Topologically, the genus of a surface is the number of ‘handles’ that need to be attached to a sphere to give the surface. One can also think of it as the number of ‘holes’ through the surface.

§21.3 The signature of a cocompact Fuchsian group

Definition. Let Γ be a Fuchsian group. Suppose that Γ has a finite-sided Dirichlet polygon $D(p)$ with all vertices in \mathbb{H} and none in $\partial\mathbb{H}$. Then we say that Γ is *cocompact*.

Let Γ be a cocompact Fuchsian group. The signature of Γ is a set of geometric data that is sufficient to reconstruct Γ as an abstract group. The signature will also allow us to generate infinitely many different cocompact Fuchsian groups.

Let $D(p)$ be a Dirichlet polygon for Γ . Then $D(p)$ has finitely many elliptic cycles, and the order of each elliptic cycle transformation is finite.

Definition. Let Γ be a cocompact Fuchsian group. Let g be the genus of \mathbb{H}/Γ . Suppose that there are k elliptic cycles $\mathcal{E}_1, \dots, \mathcal{E}_k$. Suppose that \mathcal{E}_j has order $m_{\mathcal{E}_j} = m_j$ so that $m_j \text{sum}(\mathcal{E}_j) = 2\pi$. Suppose that $\mathcal{E}_1, \dots, \mathcal{E}_r$ are non-accidental and $\mathcal{E}_{r+1}, \dots, \mathcal{E}_k$ are accidental.

The *signature* of Γ is defined to be

$$\text{sig}(\Gamma) = (g; m_1, \dots, m_r).$$

(That is, we list the genus of \mathbb{H}/Γ together with the orders of the non-accidental elliptic cycles.) If all the elliptic cycles are accidental cycles, then we write $\text{sig}(\Gamma) = (g; -)$.

§21.4 The area of a Dirichlet polygon

Let Γ be a cocompact Fuchsian group. We can use the data given by the signature of Γ to give a formula for the hyperbolic area of any fundamental domain of Γ . (Recall from Proposition 13.2.1 that, for a given Fuchsian group, any two fundamental domains have the same hyperbolic area.)

Proposition 21.4.1

Let Γ be a cocompact Fuchsian group with signature $\text{sig}(\Gamma) = (g; m_1, \dots, m_r)$. Let D be a fundamental domain for Γ . Then

$$\text{Area}_{\mathbb{H}}(D) = 2\pi \left((2g - 2) + \sum_{j=1}^r \left(1 - \frac{1}{m_j} \right) \right). \quad (21.4.1)$$

Proof. By Proposition 13.2.1 it is sufficient to prove that the formula (21.4.1) holds for a Dirichlet polygon D . As in Lecture 19, we can add extra vertices if necessary to assume that no side is paired with itself. Suppose that D has n vertices (hence n sides).

We use the Gauss-Bonnet Theorem (Theorem 7.2.1). Let $\mathcal{E}_1, \dots, \mathcal{E}_r$ be the non-accidental elliptic cycles. By Proposition 17.3.1, the angle sum along the elliptic cycle \mathcal{E}_j is

$$\text{sum}(\mathcal{E}_j) = \frac{2\pi}{m_j}$$

Suppose that there are s accidental cycles. (Recall that an elliptic cycle is said to be *accidental* if the corresponding elliptic cycle transformation is the identity, and in particular has order 1.) By Proposition 17.3.1, the internal angle sum along an accidental cycle is 2π . Hence the internal angle sum along all accidental cycles is $2\pi s$.

As each vertex must belong to some elliptic cycle (either an elliptic cycle with order at least 2, or to an accidental cycle) the sum of all the internal angles of D is given by

$$2\pi \left(\sum_{j=1}^r \frac{1}{m_j} + s \right).$$

By the Gauss-Bonnet Theorem (Theorem 7.2.1), we have

$$\text{Area}_{\mathbb{H}}(D) = (n - 2)\pi - 2\pi \left(\sum_{j=1}^r \frac{1}{m_j} + s \right). \tag{21.4.2}$$

Consider now the space \mathbb{H}/Γ . This is formed by taking D and gluing together paired sides. The vertices along each elliptic cycle are glued together; hence each elliptic cycle in D gives one vertex in the triangulation of \mathbb{H}/Γ . Hence D gives a triangulation of \mathbb{H}/Γ with $V = r + s$ vertices. As paired sides are glued together, there are $E = n/2$ edges (notice that we are assuming here that no side is paired with itself). Finally, as we only need the single polygon D , there is only $F = 1$ face. Hence

$$2 - 2g = \chi(\mathbb{H}/\Gamma) = V - E + F = r + s - \frac{n}{2} + 1$$

which rearranges to give

$$n - 2 = 2((r + s) - (2 - 2g)). \tag{21.4.3}$$

Substituting (21.4.3) into (21.4.2) we see that

$$\begin{aligned} \text{Area}_{\mathbb{H}}(D) &= 2\pi \left(r + s - (2 - 2g) - \sum_{j=1}^r \frac{1}{m_j} - s \right) \\ &= 2\pi \left((2g - 2) + \sum_{j=1}^r \left(1 - \frac{1}{m_j} \right) \right). \end{aligned}$$

□

We can use Proposition 21.4.1 to find a lower bound for the area of a Dirichlet polygon for a Fuchsian group.

Proposition 21.4.2

Let Γ be a cocompact Fuchsian group (so that the Dirichlet polygon $D(p)$ has no vertices on the boundary). Then

$$\text{Area}_{\mathbb{H}}(D) \geq \frac{\pi}{21}.$$

Proof. By Proposition 21.4.1 this is equivalent to proving

$$2g - 2 + \sum_{j=1}^r \left(1 - \frac{1}{m_j} \right) \geq \frac{1}{42}. \tag{21.4.4}$$

Notice that $1 - 1/m_j$ is always positive.

If $g > 1$ then $2g - 2 > 1$. Hence the left-hand side of (21.4.4) is greater than 1, and the result certainly holds.

Suppose that $g = 1$ (so that $2g - 2 = 0$). Now $m_1 \geq 2$ so that $1 - 1/m_1 \geq 1/2$, which is greater than $1/42$. So the result holds.

Suppose that $g = 0$ (so that $2g - 2 = -2$). As in the previous paragraph, we see that for each $j = 1, \dots, r$ we have $1 - 1/m_j \geq 1/2$. If $r \geq 5$ then the left-hand side of (21.4.4) is at least $1/2$, so the result holds. When $r = 4$ the minimum of the left-hand side of (21.4.4) occurs for signature $(0; 2, 2, 2, 3)$; in this case

$$2g - 2 + \sum_{j=1}^r \left(1 - \frac{1}{m_j}\right) \geq -2 + \frac{1}{2} + \frac{1}{2} + \frac{1}{2} + \left(1 - \frac{1}{3}\right) = \frac{1}{6}.$$

It remains to treat the case $g = 0, r = 3$. In this case, we must prove that

$$s(k, l, m) = 1 - \left(\frac{1}{k} + \frac{1}{l} + \frac{1}{m}\right) \geq \frac{1}{42}$$

for $k, l, m \geq 2$. We assume that $k \leq l \leq m$. Suppose $k = 3$ then $s(3, 3, 3) = 0$ and $s(3, 3, 4) = 1/12 > 1/42$. Hence $s(3, l, m) \geq 1/12$ so the result holds. Hence we need only concern ourselves with $k = 2$. Note that

$$s(2, 2, m) < 0, s(2, 4, 4) = 0, s(2, 4, 5) = 1/20 > 1/42, s(2, 4, m) \geq 1/20.$$

Hence we need only concern ourselves with $l = 3$. Now

$$s(2, 3, m) = \frac{1}{6} - \frac{1}{m}$$

which achieves the minimum $1/42$ when $m = 7$. □

Remark. In Lecture 22 we shall show that if $(g; m_1, \dots, m_r)$ is an $(r+1)$ -tuple of integers such that the right-hand side of (21.4.1) is positive, then there exists a Fuchsian group Γ with $\text{sig}(\Gamma) = (g; m_1, \dots, m_r)$.

Exercise 21.1

Consider the hyperbolic polygon illustrated in Figure 21.4.6 with the side-pairing transformations as indicated (note that one side is paired with itself). Assume that $\theta_1 + \theta_2 + \theta_3 = 2\pi$ (one can show that such a polygon exists).

- (i) Show that there are 3 non-accidental cycles and 1 accidental cycle.
- (ii) Show that the side-pairing transformations generate a Fuchsian group Γ and give a presentation of Γ in terms of generators and relations.
- (iii) Calculate the signature of Γ .

Exercise 21.2

Consider the regular hyperbolic octagon with each internal angle equal to θ and the sides paired as indicated in Figure 21.4.7. Use Exercise 7.3 to show that such an octagon exists provided $\theta \in [0, 3\pi/4)$.

For which values of θ do $\gamma_1, \gamma_2, \gamma_3, \gamma_4$ generate a Fuchsian group Γ_θ ? In each case when Γ_θ is a Fuchsian group write down a presentation of Γ_θ , determine the signature $\text{sig}(\Gamma_\theta)$ and briefly describe geometrically the quotient space \mathbb{H}/Γ_θ .

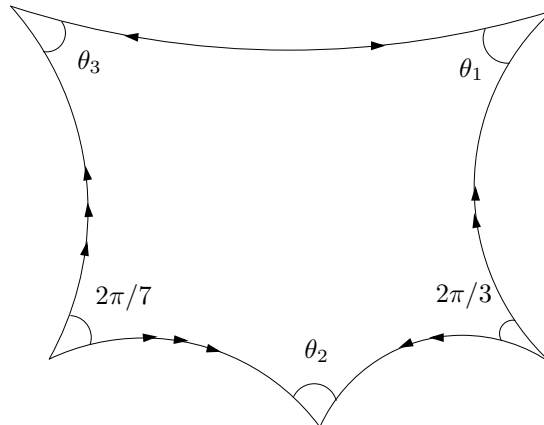

Figure 21.4.6: A hyperbolic polygon with sides paired as indicated

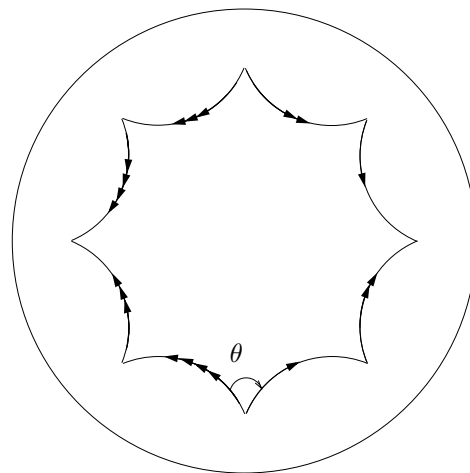

Figure 21.4.7: See Exercise 21.2

Exercise 21.3

This exercise works through Proposition 21.4.2 in the case when we allow parabolic cycles.

Let Γ be a Fuchsian group and let D be a Dirichlet polygon for D . We allow D to have vertices on $\partial\mathbb{H}$, but we assume that D has no free edges (so that no arcs of $\partial\mathbb{H}$ are edges). We also assume that no side of D is paired with itself.

The space \mathbb{H}/Γ then has a genus (heuristically, the number of handles), possibly some marked points, and cusps. The cusps arise from gluing together the vertices on parabolic cycles and identifying the sides on each parabolic cycle.

- (i) Convince yourself that the $\mathbb{H}/\text{PSL}(2, \mathbb{Z})$ has genus 0, one marked point of order 3, one marked point of order 2, and one cusp.

(Hint: remember that a side is not allowed to be paired to itself.)

Suppose that \mathbb{H}/Γ has genus g , r marked points of order m_1, \dots, m_r , and c cusps. We define the signature of Γ to be

$$\text{sig}(\Gamma) = (g; m_1, \dots, m_r; c).$$

(ii) Using the Gauss-Bonnet Theorem, show that

$$\text{Area}_{\mathbb{H}}(D) = 2\pi \left((2g - 2) + \sum_{j=1}^r \left(1 - \frac{1}{m_j} \right) + c \right).$$

(iii) Show that if $c \geq 1$ then

$$\text{Area}_{\mathbb{H}}(D) \geq \frac{\pi}{3}$$

and that this lower bound is achieved for just one Fuchsian group (which one?).

22. Existence of a Fuchsian group with a given signature

§22.1 Introduction

In Lecture 21 we defined the signature $\text{sig}(\Gamma) = (g; m_1, \dots, m_r)$ of a cocompact Fuchsian group. We saw that if D is a fundamental domain for Γ then

$$\text{Area}_{\mathbb{H}}(D) = 2\pi \left((2g - 2) + \sum_{j=1}^r \left(1 - \frac{1}{m_j} \right) \right).$$

As this quantity must be positive, the condition that

$$(2g - 2) + \sum_{j=1}^r \left(1 - \frac{1}{m_j} \right) > 0 \tag{22.1.1}$$

is a necessary condition for $(g; m_1, \dots, m_r)$ to be the signature of a Fuchsian group. The purpose of this lecture is to sketch a proof of the converse of this statement: if $(g; m_1, \dots, m_r)$ satisfies (22.1.1) then there exists a cocompact Fuchsian group with signature $(g; m_1, \dots, m_r)$. This gives a method for constructing infinitely many examples of cocompact Fuchsian groups. (Recall that a Fuchsian group Γ is said to be *cocompact* if it has a Dirichlet polygon with all its vertices inside \mathbb{H} .)

§22.2 Existence of a Fuchsian group with a given signature

Theorem 22.2.1

Let $g \geq 0$ and $m_j \geq 2, 1 \leq j \leq r$ be integers. (We allow the possibility that $r = 0$, in which case we assume that there are no m_j s.) Suppose that

$$(2g - 2) + \sum_{j=1}^r \left(1 - \frac{1}{m_j} \right) > 0. \tag{22.2.1}$$

Then there exists a cocompact Fuchsian group Γ with signature

$$\text{sig}(\Gamma) = (g; m_1, \dots, m_r).$$

Remark. In particular, for each $g \geq 2$ there exists a Fuchsian group Γ_g with signature $\text{sig}(\Gamma_g) = (g; -)$. Thus for each $g \geq 2$ we can find a Fuchsian group Γ_g such that \mathbb{H}/Γ_g is a torus of genus g .

Remark. The proof of Theorem 22.2.1 consists of constructing a polygon and a set of side-pairing transformations satisfying Poincaré's Theorem. There are two phenomena that we want to capture in this polygon.

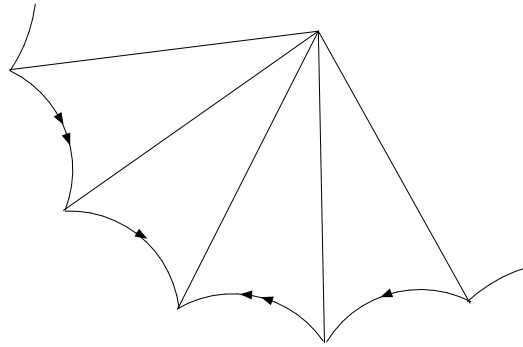

Figure 22.2.1: Glueing together the sides paired gives a handle.

- (i) We need to generate handles. By considering the example of a regular hyperbolic octagon in Lecture 19, we see that the part of a polygon illustrated in Figure 22.2.1 with the side-pairing illustrated will generate a handle.
- (ii) We need to generate marked points. By considering the discussion in Lecture 20 of how the modular group satisfies Poincaré's Theorem, we see that the part of a polygon illustrated in Figure 22.2.2 with the side pairing illustrated will generate a marked point arising from an elliptic cycle of order m .

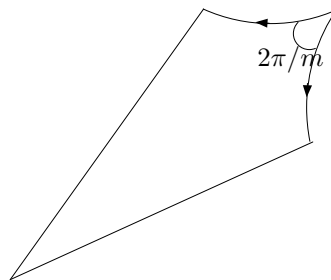

Figure 22.2.2: Glueing together the sides paired gives a marked point of order m .

Proof. The proof is essentially a big computation using Poincaré's Theorem. We construct a convex polygon, equip it with a set of side-pairing transformations, and apply Poincaré's Theorem to show that these side-pairing transformations generate a Fuchsian group. Finally, we show that this Fuchsian group has the required signature.

We work in the Poincaré disc \mathbb{D} . Consider the origin $0 \in \mathbb{D}$. Let θ denote the angle

$$\theta = \frac{2\pi}{4g + r}.$$

Draw $4g + r$ radii, each separated by angle θ . Fix $t \in (0, 1)$. On each radius, choose a point at (Euclidean) distance t from the origin. Join successive points with a hyperbolic geodesic. This gives a regular hyperbolic polygon $M(t)$ with $4g + r$ vertices.

Starting at an arbitrary point, label the vertices clockwise

$$v_1, v_2, \dots, v_r, v_{1,1}, v_{1,2}, v_{1,3}, v_{1,4}, v_{2,1}, \dots, v_{2,4}, v_{3,1}, \dots, v_{g,1}, \dots, v_{g,4}.$$

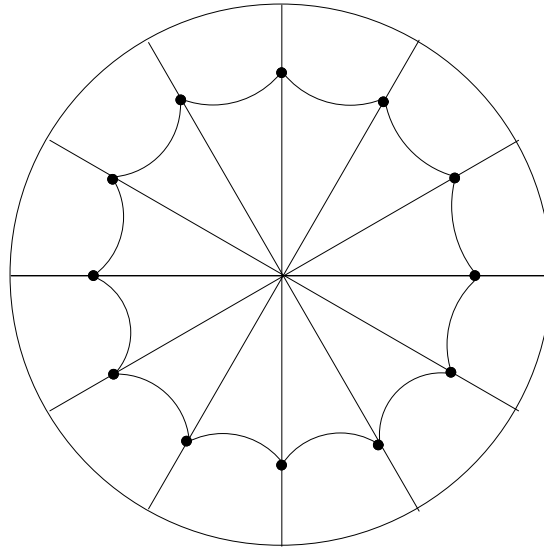

Figure 22.2.3: The polygon $M(t)$ is a regular hyperbolic $(4g + r)$ -gon

On each of the first r sides of $M(t)$ we construct an isosceles triangle, external to $M(t)$. We label the vertex at the ‘tip’ of the j^{th} isosceles triangle by w_j and construct the triangle in such a way so that the internal angle at w_j is $2\pi/m_j$. If $m_j = 2$ then $2\pi/m_j = \pi$ and we have a degenerate triangle, i.e. just an arc of geodesic constructed in the previous paragraph and w_j is the midpoint of that geodesic. Call the resulting polygon $N(t)$. See Figure 22.2.4.

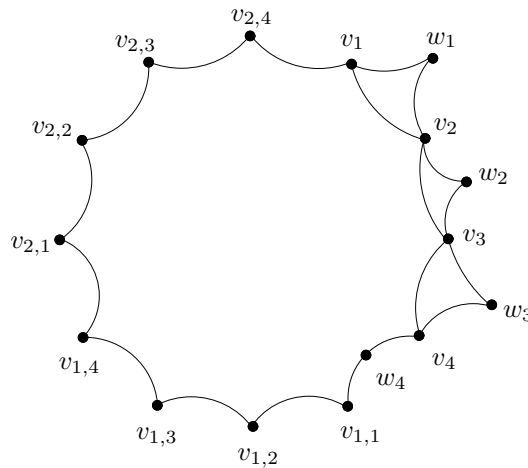

Figure 22.2.4: Illustrating $N(t)$ in the case $g = 2, r = 4$ with $m_1, m_2, m_3 > 2$ and $m_4 = 2$. The solid dots indicate vertices of $N(t)$ (note the degenerate triangle with vertex at w_4).

Consider the vertices v_j, w_j, v_{j+1} ($1 \leq j \leq r$). Pair the sides as illustrated in Figure 22.2.5 and call the side-pairing transformation γ_j . Note that γ_j is a rotation about w_j through angle $2\pi/m_j$. For each $\ell = 1, 2, \dots, g$, consider the vertices $v_{\ell,1}, v_{\ell,2}, v_{\ell,3}, v_{\ell,4}$. Pair the sides as illustrated in Figure 22.2.6 and call the side-pairing transformations $\gamma_{\ell,1}, \gamma_{\ell,2}$.

We label the sides of $N(t)$ by $s(v_j), s(v_{\ell,j}), s(w_j)$ where the side $s(v)$ is immediately

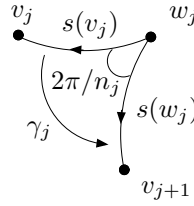

Figure 22.2.5: Pairing the sides between vertices v_j, w_j, v_{j+1} ($1 \leq j \leq r$).

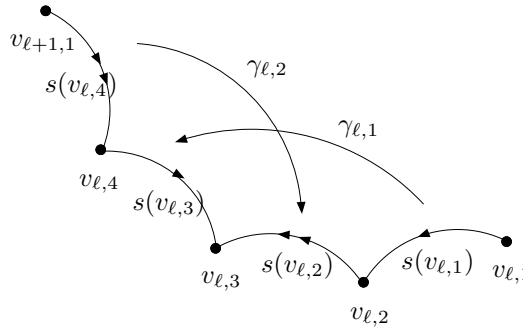

Figure 22.2.6: Pairing the sides between vertices $v_{l,1}, v_{l,2}, v_{l,3}, v_{l,4}$.

clockwise of vertex v .

We will now apply Poincaré’s Theorem to the polygon $N(t)$. Our aim is to show how to choose $t \in (0, 1)$ so that the side-pairing transformations above generate a Fuchsian group with the required signature. First we calculate the elliptic cycles.

For each $j = 1, \dots, r$, consider the pair $(w_j, s(v_j))$. Then

$$\begin{pmatrix} w_j \\ s(v_j) \end{pmatrix} \xrightarrow{\gamma_j} \begin{pmatrix} w_j \\ s(w_j) \end{pmatrix} \xrightarrow{*} \begin{pmatrix} w_j \\ s(v_j) \end{pmatrix}.$$

Hence we have an elliptic cycle w_j with corresponding elliptic cycle transformation γ_j . The angle sum is given by the internal angle at w_j , namely $\text{sum}(w_j) = 2\pi/m_j$. Hence

$$m_j \text{sum}(w_j) = 2\pi$$

so that the elliptic cycle condition holds.

Consider the pair $(v_{l,1}, s(v_{l,1}))$. Using Figure 22.2.6, we see that we get the following segment of an elliptic cycle:

$$\dots \rightarrow v_{l,1} \rightarrow v_{l,4} \rightarrow v_{l,3} \rightarrow v_{l,2} \rightarrow v_{l+1,1} \rightarrow \dots$$

with corresponding segment of elliptic cycle transformation

$$\dots \gamma_{l,2}^{-1} \gamma_{l,1}^{-1} \gamma_{l,2} \gamma_{l,1} \dots$$

which we denote by $[\gamma_{l,1}, \gamma_{l,2}]$. (Here we use the notational convention that $v_{g+1,1} = v_{1,1}$.)

Now consider the pair $(v_j, s(v_j))$. The elliptic cycle through this pair contains the following:

$$\dots \rightarrow \begin{pmatrix} v_j \\ s(v_j) \end{pmatrix} \xrightarrow{\gamma_j} \begin{pmatrix} v_{j+1} \\ s(w_j) \end{pmatrix} \xrightarrow{*} \begin{pmatrix} v_{j+1} \\ s(v_{j+1}) \end{pmatrix} \rightarrow \dots$$

Thus, starting at the pair $(v_{1,1}, s(v_{1,1}))$, we have the elliptic cycle \mathcal{E}

$$\begin{aligned} v_{1,1} \rightarrow v_{1,4} \rightarrow v_{1,3} \rightarrow v_{1,2} \rightarrow v_{2,1} \rightarrow \cdots \rightarrow v_{g-1,2} \rightarrow v_{g,1} \rightarrow \\ v_{g,4} \rightarrow v_{g,3} \rightarrow v_{g,2} \rightarrow v_1 \rightarrow v_2 \rightarrow \cdots \rightarrow v_r \end{aligned}$$

with corresponding elliptic cycle transformation

$$\gamma_r \gamma_{r-1} \cdots \gamma_1 [\gamma_{g,1}, \gamma_{g,2}] \cdots [\gamma_{1,1}, \gamma_{1,2}].$$

Let $2\alpha(t)$ denote the internal angle of each vertex in the polygon $M(t)$. Let $\beta_j(t)$ denote the internal angle at each vertex at the base of the j^{th} isosceles triangle that is added to the polygon $M(t)$ to form the polygon $N(t)$, that is $\beta_j(t)$ is the angle $\angle w_j v_j v_{j+1}$, and is also the angle $\angle w_j v_{j+1} v_j$. See Figure 22.2.7. Then the angle sum along the elliptic cycle \mathcal{E} is given by

$$\text{sum}(\mathcal{E}) = 8g\alpha(t) + 2 \sum_{j=1}^r (\alpha(t) + \beta_j(t)).$$

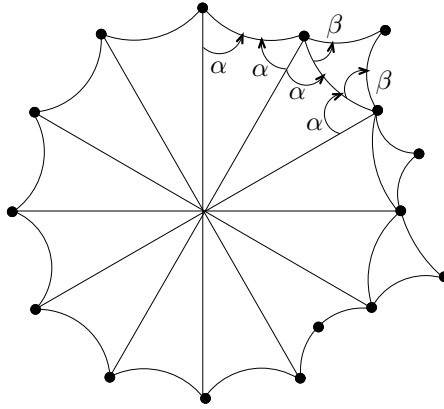

Figure 22.2.7: Labelling the angles $\alpha(t)$, $\beta_j(t)$ in the polygon $N(t)$.

We show that t (and hence the polygon $N(t)$) can be chosen so that $\text{sum}(\mathcal{E}) = 2\pi$. Then the elliptic cycle condition holds, \mathcal{E} is an accidental cycle, and we can apply Poincaré’s Theorem.

One can prove using hyperbolic trigonometry that

$$\begin{aligned} \lim_{t \rightarrow 1} \alpha(t) &= 0, \\ \lim_{t \rightarrow 1} \beta_j(t) &= 0, \\ \lim_{t \rightarrow 0} \alpha(t) &= \frac{\pi}{2} - \frac{1}{2} \frac{2\pi}{4g+r}, \\ \lim_{t \rightarrow 0} \beta_j(t) &= \frac{\pi}{2} - \frac{\pi}{m_j} \end{aligned}$$

(compare with Exercise 29.2). Now

$$\lim_{t \rightarrow 1} 8g\alpha(t) + 2 \sum_{j=1}^r (\alpha(t) + \beta_j(t)) = 0$$

and (after some rearrangement)

$$\lim_{t \rightarrow 0} 8g\alpha(t) + 2 \sum_{j=1}^r (\alpha(t) + \beta_j(t)) = 2\pi \left((2g - 2) + \sum_{j=1}^r \left(1 - \frac{1}{m_j} \right) \right) + 2\pi. \quad (22.2.2)$$

The first term in the right-hand side of (22.2.2) is positive by the assumptions of the theorem. Hence

$$\lim_{t \rightarrow 0} 8g\alpha(t) + 2 \sum_{j=1}^r (\alpha(t) + \beta_j(t)) > 2\pi.$$

As the quantities $\alpha(t)$ and $\beta_j(t)$ vary continuously in t , by the Intermediate Value Theorem there exists $t_0 \in (0, 1)$ such that

$$\text{sum}(\mathcal{E}) = 2\pi.$$

Hence, for the polygon $N(t_0)$, the elliptic cycle condition holds.

By Poincaré's Theorem, the side-pairing transformations generate a Fuchsian group Γ . It remains to check that the group Γ has the required signature.

The group Γ has r elliptic cycles corresponding to each of the w_j . The elliptic cycle transformation associated to the elliptic cycle w_j has order m_j .

Consider the space \mathbb{H}/Γ . This is formed by taking $N(t_0)$ and gluing together the paired sides. Thus \mathbb{H}/Γ has a triangulation using a single polygon (so $F = 1$) with $V = r + 1$ vertices (as there are $r + 1$ elliptic cycles) and $E = 2g + r$ edges. Let h denote the genus of \mathbb{H}/Γ . Then by the Euler formula,

$$2 - 2h = V - E + F = (r + 1) - (2g + r) + 1 = 2 - 2g.$$

Hence $h = g$. Hence Γ has signature $\text{sig}(\Gamma) = (g; m_1, \dots, m_r)$. \square

23. Properly discontinuous group actions

§23.1 Background

Recall that the set of Möbius transformations of \mathbb{H} forms a group $\text{Möb}(\mathbb{H})$ under composition. This group has a very rich structure; for example, we shall see how to define a notion of distance on this group (so that we can say how far apart two Möbius transformations of \mathbb{H} are). We shall also study a very important class of subgroups of $\text{Möb}(\mathbb{H})$ called *Fuchsian groups*. The purpose of these notes is to discuss the action of a Fuchsian group on the boundary $\partial\mathbb{H}$ in terms of its limit set. These sets are important and often intricate geometrical objects (for example, they are often of a fractal nature).

§23.2 Metric spaces

We will use several concepts from metric spaces. In this section we quickly review many of the necessary definitions. For more details, see almost any book on metric spaces (for example W.A. Sutherland, *An Introduction to Metric and Topological Spaces*, O.U.P., Oxford, 1975).

In the course we saw how to define a notion of distance on the upper half-plane \mathbb{H} . This distance function satisfies several nice properties (such as the triangle inequality). A *metric space* just abstracts these properties.

Definition. Let X be a set. We say that a function $d : X \times X \rightarrow \mathbb{R}$ is a *metric* (or *distance function*) if:

- (i) for all $x, y \in X$, we have $d(x, y) \geq 0$ and $d(x, y) = 0$ if and only if $x = y$;
- (ii) for all $x, y \in X$, we have $d(x, y) = d(y, x)$;
- (iii) the triangle inequality holds: for all $x, y, z \in X$ we have $d(x, z) \leq d(x, y) + d(y, z)$.

We call the pair (X, d) a *metric space*.

Examples.

1. Take $X = \mathbb{R}$ and define $d(x, y) = |x - y|$.
2. Take $X = \mathbb{R}^2$ and define

$$d((x_1, x_2), (y_1, y_2)) = \sqrt{|y_1 - x_1|^2 + |y_2 - x_2|^2}.$$

3. Take $X = \mathbb{H}$ with $d_{\mathbb{H}}(z, z') = \inf\{\text{length}_{\mathbb{H}}(\sigma) \mid \sigma \text{ is a piecewise continuously differentiable path from } z \text{ to } z'\}$

§23.2.1 Convergence

We know how to define convergence of sequences in \mathbb{R} : if $x_n \in \mathbb{R}$ then we say that $x_n \rightarrow x$ if for all $\varepsilon > 0$ there exists $N \in \mathbb{N}$ such that for all $n \geq N$ we have $|x_n - x| < \varepsilon$. That is, given any $\varepsilon > 0$ the distance (in \mathbb{R}) between x_n and x is less than ε provided n is sufficiently large. We can recast this definition in terms of metric spaces.

Definition. Let (X, d) be a metric space. Let $x_n \in X$ be a sequence of points in X . We say that x_n converges to $x \in X$ (and write $x_n \rightarrow x$) if for all $\varepsilon > 0$ there exists $N \in \mathbb{N}$ such that for all $n \geq N$ we have $d(x_n, x) < \varepsilon$.

§23.2.2 Open and closed sets

Let (X, d) be a metric space. Let $x \in X$ and let $\varepsilon > 0$. The set

$$B_\varepsilon(x) = \{y \in X \mid d(x, y) < \varepsilon\}$$

of all points y that are distance at most ε from x is called the *open ball of radius ε and centre x* . We can think of $B_\varepsilon(x)$ as being a small neighbourhood around the point x .

A subset $U \subset X$ is called *open* if for all $x \in U$ there exists $\varepsilon > 0$ such that $B_\varepsilon(x) \subset U$, i.e. every point x in U has a small neighbourhood that is also contained in U .

One can easily show that open balls $B_\varepsilon(x)$ are open subsets. (This is not a tautology! Our choice of terminology strongly suggests that an open ball will indeed be an open set; however one does need to check that an open ball is open.)

Definition. Let $x \in X$. An open set U containing x is called a *neighbourhood* of x .

The idea is that a neighbourhood of x contains all points that are sufficiently close to x . Recall that a sequence $x_n \in X$ converges to x if x_n is arbitrarily close to x for all sufficiently large n . With this in mind, the following should not be a surprising result.

Lemma 23.2.1

Let (X, d) be a metric space. Let $x_n, x \in X$. Then the following are equivalent:

- (i) $x_n \rightarrow x$ as $n \rightarrow \infty$;
- (ii) if U is a neighbourhood of x then there exists $N \in \mathbb{N}$ such that for all $n \geq N$ we have $x_n \in U$.

Proof. This is a case of unravelling the definitions. □

A set F is said to be *closed* if its complement $X \setminus F$ is open. There are other ways of defining closed sets:

Proposition 23.2.2

Let (X, d) be a metric space and let $F \subset X$. Then the following are equivalent:

- (i) F is closed (i.e. $X \setminus F$ is open);
- (ii) if $x_n \in F$ is a sequence of points in F such that $x_n \rightarrow x$ for some $x \in X$ then $x \in F$ (i.e. any convergent sequence of points in F has its limit in F).

Let us give some examples.

Examples.

- (i) Take $X = \mathbb{R}$ and let $I = (a, b)$ be the interval $I = \{x \in \mathbb{R} \mid a < x < b\}$. Then I is an open set. To see this, take $x \in I$ and let $\varepsilon = \min\{x - a, b - x\}$. Then $B_\varepsilon(x) = (x - \varepsilon, x + \varepsilon) \subset I$ (draw a picture). This is why we call (a, b) an *open interval*.
- (ii) Take $X = \mathbb{R}$ and let $I = [a, b] = \{x \in \mathbb{R} \mid a \leq x \leq b\}$. Then I is a closed set as its complement is $\mathbb{R} \setminus I = (-\infty, a) \cup (b, \infty)$, the union of two open sets.
- (iii) Take $X = \mathbb{R}$ and let $I = [a, b) = \{x \in \mathbb{R} \mid a \leq x < b\}$. Then I is neither open nor closed. It is not open because no small neighbourhood $(a - \varepsilon, a + \varepsilon)$ of a is contained in I . It is not closed because the sequence $x_n = b - 1/n$ lies inside I , but $x_n \rightarrow b$ and b is not in I .

In practice, sets defined by strict inequalities ($<$, $>$) normally give open sets, and sets defined by weak inequalities (\leq , \geq) normally give closed sets.

Consider the usual Euclidean metric on \mathbb{R}^2 defined by

$$d_{\mathbb{R}^2}((x_1, x_2), (y_1, y_2)) = \sqrt{|y_1 - x_1|^2 + |y_2 - x_2|^2}.$$

Let $x = (x_1, x_2)$. The open ball $B_\varepsilon(x)$ around a point x is a Euclidean disc of Euclidean radius ε and centre x . In contrast, if we work in the upper half-plane \mathbb{H} with the hyperbolic metric $d_{\mathbb{H}}$ then the open ball $B_\varepsilon(z)$ is a hyperbolic disc centred on z and with hyperbolic radius ε . However, in Exercise 5.4 we saw that a hyperbolic disc is a Euclidean disc (albeit with a different centre and radius). In particular, one can prove:

Lemma 23.2.3

The open sets in \mathbb{H} defined using the hyperbolic metric $d_{\mathbb{H}}$ are the same as the open sets in the upper half-plane using the Euclidean metric.

(For those of you familiar with the terminology: this just says that the topology generated by the hyperbolic metric is the same as the usual Euclidean topology.)

§23.2.3 Compactness

A compact metric spaces is, roughly speaking, one in which sequences of points cannot ‘escape’. There are two ways in which a sequence could escape: (i) the sequence could tend to infinity (that is, the set is ‘unbounded’), or (ii) the sequence could tend to a limit that is outside the set, as happens in Example (iii) in §23.2.2 (that is, the set is ‘not closed’).

Let (X, d) be a metric space. We say that X is (*sequentially*) *compact* if every sequence $x_n \in X$ has a convergent subsequence, i.e. there exist $n_j \rightarrow \infty$ such that $x_{n_j} \rightarrow x$ for some $x \in X$.

Examples.

- $[0, 1]$ is compact.
- $(0, 1)$ is not compact (because $x_n = 1/n$ does not have a convergent subsequence in $(0, 1)$).

Remark. There are other, equivalent, definitions of compactness, such as compactness in terms of open covers.

The characterisation of compactness in terms of the set being closed and bounded is only valid for subsets of \mathbb{R}^n . In a general metric space, a compact set is always closed and bounded, but the converse is not necessarily true. We will often restrict our attention to the following class of metric spaces.

Definition. A metric space is *proper* if every closed ball $\overline{B}_\varepsilon(x) = \{y \in X \mid d(x, y) \leq \varepsilon\}$ is compact.

Subsets of \mathbb{R}^n , the upper half-plane, the Poincaré disc, $\text{Möb}(\mathbb{H})$ are all proper metric spaces. The set of continuous real-valued functions defined on $[0, 1]$ with the metric $d(f, g) = \sup_{x \in [0, 1]} |f(x) - g(x)|$ is not a proper metric space.

Exercise 23.1

Let (X, d) be a metric space. Let $K \subset X$ be a compact subset and let $F \subset K$ be a closed subset of K . By using Proposition 23.2.2 show that F is itself compact.

§23.2.4 Continuity

Continuity is a key idea in metric spaces. Let (X, d) and (Y, ρ) be metric spaces and let $f : X \rightarrow Y$.

Definition. We say that a function $f : X \rightarrow Y$ is *continuous* at $a \in X$ if: for all $\varepsilon > 0$ there exists $\delta > 0$ such that if $d(x, a) < \delta$ then $\rho(f(x), f(a)) < \varepsilon$. We say that f is *continuous* if it is continuous at $a \in X$ for all $a \in X$.

Thus a function $f : X \rightarrow Y$ is continuous at a if points that are close to $a \in X$ get mapped by f to points that are close to $f(a) \in Y$. A function is continuous if it is continuous at each point. If X and Y are subsets of \mathbb{R} (with the usual metric) then continuity has its usual meaning: one can draw the graph of f without any breaks or jumps.

There are many other ways of characterising continuity. We give some below. First recall that if $f : X \rightarrow Y$ is a function and $U \subset Y$ then the pre-image of U under f is the set:

$$f^{-1}(U) = \{x \in X \mid f(x) \in U\}.$$

We do not assume that f is invertible here: this definition makes sense for any function f . (For example, if $f : \mathbb{R} \rightarrow \mathbb{R}$ is given by $f(x) = x^2$ then $f^{-1}(\{b\}) = \{\sqrt{b}, -\sqrt{b}\}$ if $b > 0$, $f^{-1}(\{0\}) = \{0\}$, and $f^{-1}(\{b\}) = \emptyset$ if $b < 0$.)

Lemma 23.2.4

Let (X, d) and (Y, ρ) be metric spaces and let $f : X \rightarrow Y$. Then the following are equivalent:

- (i) f is continuous;
- (ii) if $x_n \in X$ is such that $x_n \rightarrow x$ for some $x \in X$ then $f(x_n) \rightarrow f(x)$;
- (iii) if $U \subset Y$ is any open set then $f^{-1}(U) \subset X$ is an open set.

Note that Lemma 23.2.4(iii) does not say that if $U \subset X$ is open then $f(U) \subset Y$ is open (this is false in general).

Continuity also works well with compactness. The following result says that the continuous image of a compact set is compact:

Lemma 23.2.5

Let (X, d) and (Y, ρ) be metric spaces and let $f : X \rightarrow Y$ be continuous. Let $K \subset X$ be a compact set. Then $f(K) = \{f(x) \mid x \in K\} \subset Y$ is compact.

Note that this does not say that the pre-image $f^{-1}(L)$ of a compact subset $L \subset Y$ is a compact subset of X (this is false in general).

Recall that a map $\gamma : X \rightarrow X$ is an *isometry* if $d(\gamma(x), \gamma(y)) = d(x, y)$ for all $x, y \in X$.

Exercise 23.2

Prove that an isometry is continuous.

§23.2.5 Discreteness

Let $\varepsilon > 0$ and $x \in X$. We call $B_\varepsilon(x) = \{y \in X \mid d(x, y) < \varepsilon\}$ the ε -ball around x , or simply a *neighbourhood* of x .

Definition. Let $Y \subset X$ be a subset of X . We say that a point $x \in Y$ is *isolated in Y* if there exists $\varepsilon > 0$ such that $B_\varepsilon(x) \cap Y = \{x\}$, i.e. there are no points of Y (other than x itself) within distance ε of x .

Definition. Let $Y \subset X$ be a subset of X . We say that Y is *discrete* if every element of Y is isolated in Y .

Examples.

1. Take $X = \mathbb{R}$ and let $Y = \{1/n \mid n = 1, 2, 3, \dots\}$. Then Y is discrete (notice that in the definition of discreteness, the value of ε chosen is allowed to depend on the point $x \in Y$).
2. Take $X = \mathbb{R}$ and let $Y = \{1/n \mid n = 1, 2, 3, \dots\} \cup \{0\}$. Then Y is not discrete as the point 0 is not isolated: there are points of the form $1/n$ arbitrarily close to 0.

Exercise 23.3

Let (X, d) be a metric space and let $Y \subset X$. Show that the following are equivalent:

- (i) Y is a discrete subset;
- (ii) if $x_n \in Y$ is a sequence in Y such that $x_n \rightarrow x \in Y$ as $n \rightarrow \infty$, then there exists $N \in \mathbb{N}$ such that $x_n = x$ for all $n \geq N$.

§23.2.6 Limit points

Definition. Let $Y \subset X$ be an arbitrary subset of X . We say that a point $x \in X$ is a *limit point* of Y if every neighbourhood of x contains a point $y \in Y$ such that $y \neq x$.

We let $\Lambda(Y)$ denote the set of all limit points of the subset Y .

Example. Take $X = \mathbb{R}$ and $Y = \{(-1)^n + 1/n \mid n = 1, 2, \dots\}$. Then Y has two limit points: -1 and 1 .

Example. Take $X = \mathbb{R}$ and $Y = \mathbb{Q}$. As any real number can be arbitrarily well-approximated by a rational, we see that every real number is a limit point of Y .

Example. Let Y be a finite subset of a metric space X . Then there are no limit points.

§23.3 Properly discontinuous group actions

Let (X, d) be a metric space. For example, we could have $X = \mathbb{R}^2$ with the usual Euclidean metric, or $X = \mathbb{H}$ with the hyperbolic metric.

Let Γ be a group of homeomorphisms of X and let $x \in X$. (Later on we will assume in addition that Γ is a group of isometries, but for the moment we need only assume that the elements of Γ are homeomorphisms.)

Definition. The *orbit of x under Γ* is the set

$$\Gamma(x) = \{\gamma(x) \mid \gamma \in \Gamma\} \subset X.$$

That is, the orbit $\Gamma(x)$ of x under Γ is the set of points one can reach starting at x and applying every possible element of Γ .

Definition. The *stabiliser of x under Γ* is the set

$$\text{Stab}_\Gamma(x) = \{\gamma \in \Gamma \mid \gamma(x) = x\} \subset \Gamma.$$

That is, the stabiliser $\text{Stab}_\Gamma(x)$ of x under Γ is the set of transformations in Γ that leave x fixed.

Exercise 23.4

Show that, for each $x \in X$, $\text{Stab}_\Gamma(x)$ is a subgroup of Γ .

Examples.

- (i) Let $X = \mathbb{R}^2$ with the Euclidean metric. Let $\Gamma = \{\gamma_{n,m} \mid \gamma_{n,m}(x, y) = (x + n, y + m), (n, m) \in \mathbb{Z}^2\}$ denote the group of isometries of \mathbb{R}^2 given by integer translations. Then the orbit of the origin is $\Gamma((0, 0)) = \{(n, m) \mid (n, m) \in \mathbb{Z}^2\}$, i.e. the integer lattice. The stabiliser of the origin is $\text{Stab}_\Gamma((0, 0)) = \{\gamma_{0,0}\}$, i.e. the only isometry in Γ that fixes the origin is the identity.
- (ii) Let $X = \mathbb{D}$ with the hyperbolic metric $d_{\mathbb{D}}$. Let $\Gamma = \{\gamma_\theta \mid \gamma_\theta(z) = e^{2\pi i\theta}z, \theta \in [0, 1)\}$ denote the group of rotations around the origin in \mathbb{D} . Let $z = re^{i\theta} \in \mathbb{D}$. Then the orbit $\Gamma(z)$ of z is the (Euclidean) circle in \mathbb{D} of radius r . If $z \neq 0$ then the stabiliser $\text{Stab}_\Gamma(z)$ of z contains just the identity transformation. As every transformation in Γ fixes 0, the stabiliser of the origin is Γ : $\text{Stab}_\Gamma(0) = \Gamma$.
- (iii) Let $X = \mathbb{R}^2$ with the Euclidean metric. Let $\Gamma = \{\text{id}, \gamma_1, \gamma_2, \gamma_3\}$ where $\text{id}, \gamma_1, \gamma_2, \gamma_3$ denote the identity and rotations around the origin through angles 90, 180, 270 degrees, respectively. Then the orbit of $(x, y) \in \mathbb{R}^2$ contains either 4 points forming a square (if $(x, y) \neq (0, 0)$) or is the origin (if $(x, y) = (0, 0)$). If $(x, y) \neq (0, 0)$ then $\text{Stab}_\Gamma((x, y)) = \{\text{id}\}$; however, $\text{Stab}_\Gamma((0, 0)) = \Gamma$.
- (iv) Let $X = \mathbb{H}$ with the hyperbolic metric $d_{\mathbb{H}}$. Let $\Gamma = \{\gamma_n \mid \gamma_n(z) = z + n, n \in \mathbb{Z}\}$ denote the group of integer translations. Then, for any $z \in \mathbb{H}$, the orbit of z is $\Gamma(z) = \{z + n \mid n \in \mathbb{Z}\}$, the set of integer translations of z . As no translation, other than the identity, fixes any point we have that $\text{Stab}_\Gamma(z) = \{\text{id}\}$.

Exercise 23.5

Let $X = \mathbb{H}$ with the hyperbolic metric $d_{\mathbb{H}}$. Let $\Gamma = \text{Möb}(\mathbb{H})$ be the group of all Möbius transformations of \mathbb{H} . Calculate the orbit of i and the stabiliser of i .

Exercise 23.6

Calculate $\text{Stab}_{\text{PSL}(2, \mathbb{Z})}(i)$.

In the first, third and fourth examples above we have the following property: the orbit of every point in X is a discrete subset of X , and the stabiliser of every point is finite. Heuristically, this means the following: if $x \in X$, then $\gamma(x)$ is moved a long way from x , except for possibly finitely many γ that leave x fixed. Contrast this with the second example. Here, the orbit of z can contain points other than z that are arbitrarily close to z ; moreover, for some points (actually, just the origin) there are infinitely many transformations that fix z . This motivates the following definition.

Definition. Let (X, d) be a metric space and let Γ be a group of homeomorphisms of X . Then Γ acts *properly discontinuously* on X if: for all $x \in X$ and for all non-empty compact subsets $K \subset X$ the set $\{\gamma \in \Gamma \mid \gamma(x) \in K\}$ is finite.

Heuristically we think of a compact set containing x as being a small closed set around x . Thus Γ acts properly discontinuously if, given any point $x \in X$, all but finitely many transformations in Γ move the point x a long way from where it started.

There are many equivalent ways of defining what it means for a group of homeomorphisms to act properly discontinuously. The following will be the most important for our purposes.

Lemma 23.3.1

Let (X, d) be a proper metric space and let Γ be a group of homeomorphisms of X . Then the following are equivalent:

- (i) Γ acts properly discontinuously on X ;
- (ii) for all $x \in X$,
 - (a) the orbit $\Gamma(x)$ is a discrete subset of X , and
 - (b) the stabiliser $\text{Stab}_{\Gamma}(x)$ is a finite subgroup of Γ .

Proof. We prove (i) implies (ii). Suppose that Γ acts properly discontinuously.

Suppose, for a contradiction, that $\Gamma(x)$ is not discrete. Then there exist $\gamma_n \in \Gamma$ and $x_0 \in X$ such that $\gamma_n(x) \rightarrow x_0$ and all the points $\gamma_n(x)$ are pairwise distinct. Let $\varepsilon > 0$ and let $K = \overline{B_\varepsilon(x_0)}$. As X is a proper metric space, K is compact. As $\gamma_n(x) \rightarrow x_0$, there exists N such that if $n \geq N$ then $\gamma_n(x) \in K$. As the points $\gamma_n(x)$ are pairwise distinct it follows that the transformations γ_n are pairwise distinct. Hence there are infinitely many $\gamma_n \in \Gamma$ such that $\gamma_n(x) \in K$, contradicting the fact that Γ acts properly discontinuously.

Now let $x \in X$ and let $K = \{x\}$. Then K is compact. Clearly

$$\text{Stab}_{\Gamma}(x) = \{\gamma \in \Gamma \mid \gamma(x) = x\} = \{\gamma \in \Gamma \mid \gamma(x) \in K\}.$$

As Γ acts properly discontinuously, we have that $\{\gamma \in \Gamma \mid \gamma(x) \in K\}$ is finite. Hence $\text{Stab}_{\Gamma}(x)$ is finite.

We prove (ii) implies (i). Suppose that, for all $x \in X$, we have that $\Gamma(x)$ is discrete and $\text{Stab}_{\Gamma}(x)$ is finite. Let K be compact and let $x \in X$. We want to show that $\{\gamma \in \Gamma \mid \gamma(x) \in K\}$ is finite.

Suppose not, i.e. there exist infinitely many distinct $\gamma_n \in \{\gamma \in \Gamma \mid \gamma(x) \in K\}$. Consider the set of points $\{\gamma_n(x) \mid \gamma_n(x) \in K\}$. This set could be finite or infinite. If it is infinite then,

as K is compact, the sequence of points $\gamma_n(x)$ has a convergent subsequence; by taking a further subsequence if necessary we can assume that the points in this subsequence are distinct. Hence $\{\gamma_n(x)\}$ has a limit point. Hence $\Gamma(x)$ has a limit point. This contradicts the fact that $\Gamma(x)$ is discrete.

Now suppose that there are infinitely many distinct $\gamma_n \in \{\gamma \in \Gamma \mid \gamma(x) \in K\}$ but that the set of points $\{\gamma_n(x)\}$ is finite. Write $\{\gamma_n(x)\} = \{x^{(1)}, \dots, x^{(k)}\}$. For each j , $1 \leq j \leq k$, consider the set $\{\gamma_n \mid \gamma_n(x) = x^{(j)}\}$. We want to show that this set is finite. As each stabiliser is finite, let $\text{Stab}_\Gamma(x) = \{g_1, \dots, g_r\}$. For each j , fix a choice $\gamma_*^{(j)} \in \{\gamma_n \mid \gamma_n(x) = x^{(j)}\}$. Let $\gamma \in \{\gamma_n \mid \gamma_n(x) = x^{(j)}\}$. Then $\gamma(x) = x^{(j)} = \gamma_*^{(j)}(x)$, so that $(\gamma_*^{(j)})^{-1}\gamma \in \text{Stab}_\Gamma(x)$. Hence for some $1 \leq \ell \leq r$ we have that $(\gamma_*^{(j)})^{-1}\gamma = g_\ell$. Hence $\gamma = \gamma_*^{(j)}g_\ell$. Hence there are only finitely many possibilities for γ . Hence $\{\gamma_n \mid \gamma_n(x) = x^{(j)}\}$ is finite.

Hence $\{\gamma \in \Gamma \mid \gamma(x) \in K\}$ is finite. \square

Here is another equivalent condition for a group of isometries to act properly discontinuously.

Proposition 23.3.2

Let (X, d) be a proper metric space and let Γ be a group of isometries of X . Then the following are equivalent:

- (i) Γ acts properly discontinuously;
- (ii) each point $x \in X$ has a neighbourhood U containing x such that $\gamma(U) \cap U \neq \emptyset$ for only finitely many $\gamma \in \Gamma$.

Proof. Recall from Lemma 23.3.1 that a group Γ of isometries acts on X properly discontinuously if and only if the orbit $\Gamma(x)$ of each point $x \in X$ is discrete and the stabiliser $\text{Stab}_\Gamma(x)$ is finite.

We prove (i) implies (ii). Let $x \in X$. As the orbit $\Gamma(x)$ of x is discrete, there exists $\varepsilon > 0$ such that $B_\varepsilon(x)$ does not contain any points of $\Gamma(x)$ other than x . Let $U \subset B_{\varepsilon/2}(x)$ be a neighbourhood of x . Suppose that $\gamma(U) \cap U \neq \emptyset$. Let $y \in \gamma(U) \cap U$. Then, as $y \in U$, we have that $d(x, y) < \varepsilon/2$. As $y \in \gamma(U)$ we have $d(y, \gamma(x)) < \varepsilon/2$. Hence by the triangle inequality, $d(x, \gamma(x)) \leq d(x, y) + d(y, \gamma(x)) < \varepsilon$. Hence $\gamma(x) \in B_\varepsilon(x)$. As $B_\varepsilon(x)$ does not contain any points in $\Gamma(x)$ other than x , it follows that $\gamma(x) = x$, i.e. $\gamma \in \text{Stab}_\Gamma(x)$. Hence there are only finitely many $\gamma \in \Gamma$ for which $\gamma(U) \cap U \neq \emptyset$.

We prove that (ii) implies (i). Let $x \in X$ and suppose, for a contradiction, that $\Gamma(x)$ is not discrete. Choose pairwise distinct γ_n such that $\gamma_n(x) \rightarrow x_\infty$ for some $x_\infty \in X$ but $\gamma_n(x) \neq x_\infty$. Let U be the neighbourhood of x_∞ given by (ii). Then there exists $N \in \mathbb{N}$ such that if $n \geq N$ then $\gamma_n(x) \in U$. Now if $n \geq N$ then $\gamma_n(x) \in U$ and $\gamma_N(x) \in U$. Hence $x \in \gamma_n^{-1}U \cap \gamma_N^{-1}U$. Hence

$$\gamma_N^{-1}(U \cap \gamma_n \gamma_n^{-1}U) = \gamma_N^{-1}U \cap \gamma_n^{-1}U \neq \emptyset.$$

By (ii), there are only finitely many possibilities for $\gamma_N \gamma_n^{-1}$, $n \geq N$, contradicting the fact that the γ_n are pairwise distinct.

Let $x \in X$ and suppose that $\text{Stab}_\Gamma(x)$ is infinite. Then there exist infinitely many distinct $\gamma_n \in \Gamma$ such that $\gamma_n(x) = x$. Let U be the neighbourhood of x in (ii). Then $x = \gamma_n(x) \in \gamma_n(U)$. Hence $x \in \gamma_n(U) \cap U$. But there are only finitely many γ_n with this property, a contradiction. \square

Exercise 23.7

Recall that the modular group $\Gamma = \text{PSL}(2, \mathbb{Z})$ acts by homeomorphisms on $\partial\mathbb{H}$. Show that Γ does not act properly discontinuously in three ways: (i) by showing that it does not satisfy the definition of a properly discontinuous group actions, (ii) by finding a point x such that $\Gamma(x)$ is not discrete, (iii) by finding a point x such that $\text{Stab}_\Gamma(x)$ is infinite.

Exercise 23.8

Naively, one might expect the intersection between a compact set and a discrete set to be finite. This is not the case, and it is easy to find counterexamples. (Can you think of one?)

(i) Give an example of a metric space X , a group Γ of homeomorphisms acting on X , a point $x \in X$ and a compact set K such that $\Gamma(x)$ is discrete but $K \cap \Gamma(x)$ is infinite.

(ii) Suppose that Γ is now a group of isometries.

Suppose that the orbit $\Gamma(x)$ of x is discrete. Show that one can find $\varepsilon > 0$ such that $B_\varepsilon(\gamma(x)) \cap \Gamma(x) = \{\gamma(x)\}$ for all $\gamma \in \Gamma$. (That is, the ε in the definition of discreteness can be chosen to be independent of the point in the orbit.)

(ii) Conclude that if Γ acts by isometries, $\Gamma(x)$ is discrete and K is compact then $K \cap \Gamma(x)$ is finite.

24. Limit sets of Fuchsian groups

§24.1 Fuchsian groups

We first recall the definition of a Fuchsian group.

Definition. A subgroup $\Gamma < \text{Möb}(\mathbb{H})$ of Möbius transformations of \mathbb{H} is called a *Fuchsian group* if it is discrete subset of $\text{Möb}(\mathbb{H})$.

Thus if Γ is a Fuchsian group and $\gamma_n \in \Gamma$ is such that $\gamma_n \rightarrow \gamma \in \Gamma$ then $\gamma_n = \gamma$ for all sufficiently large n .

Similar definitions continue to hold for the Poincaré disc model \mathbb{D} of the hyperbolic plane. A transformation $\gamma : \mathbb{D} \mapsto \mathbb{D}$ of the form

$$\gamma(z) = \frac{\alpha z + \beta}{\bar{\beta} z + \bar{\alpha}}$$

where $\alpha, \beta \in \mathbb{C}$ and $|\alpha|^2 - |\beta|^2 > 0$ is called a *Möbius transformation of \mathbb{D}* . The collection of all such transformations is denoted by $\text{Möb}(\mathbb{D})$. There is no loss in assuming that $\gamma \in \text{Möb}(\mathbb{D})$ is *normalised*, namely that $|\alpha|^2 - |\beta|^2 = 1$. A metric can be defined in a similar way as in (12.2.2).

Let us recall some examples of Fuchsian groups.

Examples.

1. The subgroup $\Gamma = \{\gamma_n \mid \gamma_n(z) = z + n, n \in \mathbb{Z}\} < \text{Möb}(\mathbb{H})$ of all integer translations of \mathbb{H} is a Fuchsian group.
2. The subgroup $\Gamma = \{\gamma_n \mid \gamma_n(z) = 2^n z, n \in \mathbb{Z}\} < \text{Möb}(\mathbb{H})$ is a Fuchsian group.
3. Let $\theta \in \mathbb{R}$. Consider the subgroup $\Gamma = \{\gamma_\theta^n \mid \gamma_\theta^n(z) = e^{2\pi i n \theta} z, n \in \mathbb{Z}\}$ of $\text{Möb}(\mathbb{D})$. If θ is rational then this is a finite group, and so a Fuchsian group. If θ is irrational then this group is infinite; one can check that in this case Γ is not a Fuchsian group.
4. The modular group

$$\text{PSL}(2, \mathbb{Z}) = \left\{ z \mapsto \frac{az + b}{cz + d} \mid a, b, c, d \in \mathbb{Z}, ad - bc = 1 \right\} < \text{Möb}(\mathbb{H})$$

is a Fuchsian group.

5. Let $q \in \mathbb{N}$. The level- q modular group

$$\left\{ z \mapsto \frac{az + b}{cz + d} \mid \begin{array}{l} a, b, c, d \in \mathbb{Z}, ad - bc = 1, \\ b, c \text{ are divisible by } q \end{array} \right\} < \text{Möb}(\mathbb{H})$$

is a Fuchsian group.

6. Let $q \in \mathbb{N}$. The principal congruence subgroup of level q is the group

$$\left\{ z \mapsto \frac{az + b}{cz + d} \mid \begin{array}{l} a, b, c, d \in \mathbb{Z}, \quad ad - bc = 1, \\ b, c \text{ are divisible by } q, \\ a, d \equiv 1 \pmod{q} \end{array} \right\} < \text{Möb}(\mathbb{H})$$

is a Fuchsian group.

§24.2 Fuchsian groups and properly discontinuous group actions

The goal of this subsection is to prove the following result.

Theorem 24.2.1

Let Γ be a subgroup of $\text{Möb}(\mathbb{H})$ (or $\text{Möb}(\mathbb{D})$). Then Γ is a Fuchsian group if and only if Γ acts properly discontinuously on \mathbb{H} (or \mathbb{D}).

For convenience we will work in \mathbb{H} . We first need the following lemma.

Lemma 24.2.2

Fix $z_0 \in \mathbb{H}$ and let $K \subset \mathbb{H}$ be a non-empty compact set. Then

$$E = \{ \gamma \in \text{Möb}(\mathbb{H}) \mid \gamma(z_0) \in K \}$$

(i.e. the set of all Möbius transformations of \mathbb{H} that map z_0 into K) is a compact subset of $\text{Möb}(\mathbb{H})$.

Proof. Let $Sl(2, \mathbb{R})$ denote the group of 2×2 matrices with real coefficients and determinant 1. Recall the map $\theta : Sl(2, \mathbb{R}) \rightarrow \text{Möb}(\mathbb{H})$ given by

$$\theta \left(\begin{array}{cc} a & b \\ c & d \end{array} \right) = \gamma_A$$

where $\gamma_A \in \text{Möb}(\mathbb{H})$ is the Möbius transformation of \mathbb{H} with coefficient given by the matrix A : $\gamma_A(z) = (az + b)/(cz + d)$. The map θ is continuous.

Let

$$E' = \left\{ \left(\begin{array}{cc} a & b \\ c & d \end{array} \right) \in Sl(2, \mathbb{R}) \mid \frac{az_0 + b}{cz_0 + d} \in K \right\}.$$

Then $\theta(E') = E$. If we can prove that E' is a compact subset of $Sl(2, \mathbb{R})$ then it follows that E , as the continuous image of a compact set, is a compact subset of $\text{Möb}(\mathbb{H})$.

Now $Sl(2, \mathbb{R})$ can be regarded as a subset of \mathbb{R}^4 (via the map $\left(\begin{array}{cc} a & b \\ c & d \end{array} \right) \mapsto (a, b, c, d)$).

Hence to prove that E' is compact it is sufficient to prove that E' is closed and bounded.

Define $\psi : Sl(2, \mathbb{R}) \rightarrow \mathbb{H}$ by

$$\psi \left(\begin{array}{cc} a & b \\ c & d \end{array} \right) = \frac{az_0 + b}{cz_0 + d}.$$

Then ψ is continuous. Moreover, $E' = \psi^{-1}(K)$. As $K \subset \mathbb{H}$ is compact, and so closed, it follows that E' is closed.

As $K \subset \mathbb{H}$ is compact, in particular it is bounded. Hence there exists $M_1 > 0$ such that

$$\left| \frac{az_0 + b}{cz_0 + d} \right| \leq M_1 \text{ for all } \left(\begin{array}{cc} a & b \\ c & d \end{array} \right) \in E'.$$

Moreover, as $K \subset \mathbb{H}$ is compact, it is bounded away from the real axis. Hence there exists $M_2 > 0$ such that

$$\operatorname{Im} \left(\frac{az_0 + b}{cz_0 + d} \right) \geq M_2 \text{ for all } \begin{pmatrix} a & b \\ c & d \end{pmatrix} \in E'.$$

Now

$$\operatorname{Im} \left(\frac{az_0 + b}{cz_0 + d} \right) = \frac{1}{|cz_0 + d|^2} \operatorname{Im}(z_0).$$

It follows that

$$|cz_0 + d| \leq \sqrt{\frac{\operatorname{Im} z_0}{M_2}} \quad (24.2.1)$$

and

$$|az_0 + b| \leq M_1 \sqrt{\frac{\operatorname{Im} z_0}{M_2}}. \quad (24.2.2)$$

Call the constants appearing on the right-hand side of (24.2.1) and (24.2.2) C_1 and C_2 respectively, and note that they are independent of a, b, c, d . Let $z_0 = x_0 + iy_0$. Then from (24.2.1) we have that

$$(cx_0 + d)^2 + c^2y_0^2 = |cz_0 + d|^2 \leq C_1^2$$

from which it follows that $|c| \leq C_1/y_0$ and so is bounded. We also have that $|cx_0 + d| \leq C_1$, hence

$$-C_1 - \frac{C_1x_0}{y_0} \leq -C_1 - cx_0 \leq d \leq C_1 - cx_0 \leq C_1 + \frac{C_1x_0}{y_0}$$

so that d is also bounded. From (24.2.2) it follows that a, b are also bounded. \square

We will also need the following technical property.

Proposition 24.2.3

Let Γ be a subgroup of $\operatorname{Möb}(\mathbb{H})$ that acts properly discontinuously on \mathbb{H} . Suppose that $p \in \mathbb{H}$ is fixed by some non-trivial element of Γ . Then there exists a neighbourhood W of p such that no other point of W is fixed by an element of Γ other than the identity.

In other words, if p is fixed for some $\gamma \in \Gamma$ then, near p , no other point is fixed by any non-trivial element of Γ .

Remark. In particular, it follows from Proposition 24.2.3 that if Γ acts properly discontinuously then there exists $p \in \mathbb{H}$ such that $\gamma(p) \neq p$ for all $\gamma \in \Gamma \setminus \{\operatorname{id}\}$. In Lecture 14 we use this property to give an algorithm that generates a fundamental domain for a given Fuchsian group.

Proof of Proposition 24.2.3. Suppose that $\gamma(p) = p$ for some $p \in \mathbb{H}$ and $\gamma \in \Gamma$, $\gamma \neq \operatorname{id}$. Suppose, for a contradiction, that in any neighbourhood of p there exists a fixed point for some non-trivial transformation in Γ , i.e. there exists a sequence of distinct points $p_n \in \mathbb{H}$ and $\gamma_n \in \Gamma \setminus \{\operatorname{id}\}$ such that $p_n \rightarrow p$ and $\gamma_n(p_n) = p_n$. Hence γ_n is an elliptic Möbius transformation of \mathbb{H} with a fixed point at p_n ; hence the γ_n are pairwise distinct.

Let $\overline{B_{3\varepsilon}}(p)$ be the closed 3ε -ball centred on p . This set is compact. From the definition of a properly discontinuous group action it follows that

$$\{\gamma \in \Gamma \mid \gamma(p) \in \overline{B_{3\varepsilon}}(p)\}$$

is finite. Hence only finitely many of the γ_n belong to this set. Hence there exists $N_1 \in \mathbb{N}$ such that if $n \geq N_1$ then $d_{\mathbb{H}}(\gamma_n(p), p) > 3\varepsilon$. As $p_n \rightarrow p$, it follows that there exists $N_2 \in \mathbb{N}$ such that if $n \geq N_2$ then $d_{\mathbb{H}}(p_n, p) < \varepsilon$. Choose $n \geq \max\{N_1, N_2\}$. Then

$$\begin{aligned} d_{\mathbb{H}}(\gamma_n(p), p) &\leq d_{\mathbb{H}}(\gamma_n(p), \gamma_n(p_n)) + d_{\mathbb{H}}(\gamma_n(p_n), p) \\ &= d_{\mathbb{H}}(p, p_n) + d_{\mathbb{H}}(p_n, p) \leq 2\varepsilon \end{aligned}$$

(as γ_n is an isometry, and $\gamma_n(p_n) = p_n$), a contradiction. □

Exercise 24.1

Give an example of a metric space (X, d) and a group Γ of isometries that acts properly discontinuously on X for which the conclusion of Proposition 24.2.3 fails, i.e. there exists a point $p \in X$ which is fixed by some non-trivial element of Γ and for which there are points arbitrarily close (but not equal) to p that are also fixed under some non-trivial elements of Γ . (Hint: where did we use the fact that we are working with Möbius transformations in the above proof?)

We can now prove Theorem 24.2.1.

Proof of Theorem 24.2.1. Let Γ be a Fuchsian group. We prove that Γ acts properly discontinuously on \mathbb{H} . Let $z \in \mathbb{H}$ and let $K \subset \mathbb{H}$ be a non-empty compact set. Then

$$\{\gamma \in \Gamma \mid \gamma(z) \in K\} = \{\gamma \in \text{Möb}(\mathbb{H}) \mid \gamma(z) \in K\} \cap \Gamma. \tag{24.2.3}$$

The first set on the right-hand side of (24.2.3) is compact by Lemma 24.2.2, and the second set is discrete. Hence $\{\gamma \in \Gamma \mid \gamma(z) \in K\}$ is finite. Hence Γ acts properly discontinuously.

Conversely, suppose that Γ acts properly discontinuously but is not discrete. By Proposition 24.2.3 and the remark following it, there exists $p \in \mathbb{H}$ that is not fixed by any element in Γ other than the identity. As Γ is not discrete, there exists pairwise distinct $\gamma_n \in \Gamma$ such that $\gamma_n \rightarrow \text{id}$. Hence $\gamma_n(p) \rightarrow p$ and $\gamma_n(p) \neq p$.

Let U be any neighbourhood of p . Then $\gamma_n(p) \in U$ for sufficiently large n . Clearly $\gamma_n(p) \in \gamma_n(U)$. Hence there exist infinitely many $\gamma_n \in \Gamma$ such that $\gamma_n(U) \cap U \neq \emptyset$, contradicting Proposition 23.3.2. □

Recall that Lemma 23.3.1 says that a group acts properly discontinuously if and only if each orbit is discrete and each stabiliser is finite. For Fuchsian groups, we do not need to check that stabiliser of each point is finite (heuristically, this isn't surprising: for γ is in $\text{Stab}_{\Gamma}(z)$ if and only if z is a fixed point of γ , and we know that Möbius transformations have very few fixed points).

Proposition 24.2.4

Let $\Gamma < \text{Möb}(\mathbb{H})$ be a subgroup of the Möbius group. Then the following are equivalent:

- (i) Γ acts properly discontinuously on \mathbb{H} ;
- (ii) for all $z \in \mathbb{H}$, the orbit $\Gamma(z) \subset \mathbb{H}$ is a discrete subset of \mathbb{H} .

Proof. We prove (i) implies (ii). If Γ acts properly discontinuously then, by Lemma 23.3.1, the orbit $\Gamma(z)$ of every $z \in \mathbb{H}$ is discrete.

Conversely, we prove (ii) implies (i). We work in \mathbb{D} for convenience. By Lemma 23.3.1 we need only prove that the stabiliser of each point $z_0 \in \mathbb{D}$ is finite. Let $\gamma \in \text{Stab}_{\Gamma}(z_0)$. Then $\gamma(z_0) = z_0$, so that γ has fixed point at z_0 ; hence γ is either elliptic or the identity.

Recall that a Möbius transformation of \mathbb{D} is elliptic if and only if it is conjugate to a rotation about $0 \in \mathbb{D}$. Thus $\text{Stab}_\Gamma(z_0)$ is conjugate to S , a subgroup of

$$\{\gamma_\theta \mid \gamma_\theta(z) = e^{2\pi i\theta}z, \theta \in [0, 1]\}.$$

That is, there exists $g \in \text{Möb}(\mathbb{D})$ such that $g \text{Stab}_\Gamma(z_0)g^{-1} = S$. Suppose that $\text{Stab}_\Gamma(z_0)$ is infinite. Then S is infinite and there exist infinitely many distinct $\theta_j \in [0, 1]$ for which $\gamma_{\theta_j} \in S$. As $[0, 1]$ is compact, we can choose a convergent subsequence $\theta_{j_n} \rightarrow \theta$, for some $\theta \in [0, 1]$. It is straightforward to check that $\text{Stab}_\Gamma(z_0)$ is a closed subgroup of Γ (that is, if $\gamma_n \in \text{Stab}_\Gamma(z_0)$ and $\gamma_n \rightarrow \gamma \in \text{Möb}(\mathbb{D})$ then $\gamma \in \text{Stab}_\Gamma(z_0)$); hence S is also closed. Hence $\gamma_\theta \in S$. Fix any $z_1 \in \mathbb{D}$, $z_1 \neq 0$. Then $\gamma_{\theta_{j_n}}(z_1) \rightarrow \gamma_\theta(z_1)$ as $n \rightarrow \infty$ and all the $\gamma_{\theta_{j_n}}(z_1)$ are distinct. Let $\gamma_n = g^{-1}\gamma_{\theta_{j_n}}g \in \text{Stab}_\Gamma(z_0)$. Then $\gamma_n(g^{-1}z_1) \rightarrow g^{-1}\gamma_\theta z_1$ and all the $\gamma_n(g^{-1}z_1)$ are distinct. Hence the orbit of z_1 is not discrete, a contradiction. \square

Remark. It is important to realise that Proposition 24.2.4 fails if we consider the orbit of a point $z \in \partial\mathbb{H}$. For example, take $\Gamma = \text{PSL}(2, \mathbb{Z})$; this is a Fuchsian group. However, it is easy to see that $\Gamma(0)$, the orbit of the point $0 \in \partial\mathbb{H}$, is equal to $\mathbb{Q} \cup \{\infty\}$, which is not discrete.

In particular, we have the following important corollary.

Corollary 24.2.5

Let Γ be a Fuchsian group and let $z \in \mathbb{H}$. Then $\Gamma(z)$ has no limit points inside \mathbb{H} .

Thus if $\Gamma(z)$ has any limit points, then they must lie on the boundary.

§24.3 The limit set of a Fuchsian group

For convenience, we will work in the Poincaré disc model of the hyperbolic plane. Let Γ be a Fuchsian group acting on the Poincaré disc \mathbb{D} .

We will be interested in the orbit $\Gamma(z)$ of a point $z \in \mathbb{D}$. We shall view $\Gamma(z)$ as a subset of $\mathbb{D} \cup \partial\mathbb{D}$. Note that

$$\mathbb{D} \cup \partial\mathbb{D} = \{z \in \mathbb{C} \mid |z| \leq 1\},$$

the closed unit disc in \mathbb{C} . We give $\mathbb{D} \cup \partial\mathbb{D}$ the Euclidean topology: a sequence points $z_n \in \mathbb{D} \cup \partial\mathbb{D}$ converges to $z \in \mathbb{D} \cup \partial\mathbb{D}$ if $|z_n - z| \rightarrow 0$ as $n \rightarrow \infty$, where $|\cdot|$ denotes the modulus of a complex number.

Remark. If we are working in \mathbb{D} then $d_{\mathbb{D}}(z_n, z) \rightarrow 0$ if and only if $|z_n - z| \rightarrow 0$. However, when we are working with limit sets we are often looking at convergence in $\mathbb{D} \cup \partial\mathbb{D}$. As points on $\partial\mathbb{D}$ are an infinite distance away from points in \mathbb{D} , it does not make sense to consider convergence using the hyperbolic metric \mathbb{D} .

Definition. Let Γ be a Fuchsian group acting on the Poincaré disc \mathbb{D} and let $z \in \mathbb{D}$. Let $\Lambda(\Gamma(z))$ denote the set of limit points in $\mathbb{D} \cup \partial\mathbb{D}$ of the orbit $\Gamma(z)$.

Remarks.

- (i) Let $z \in \mathbb{D}$. Thus a point $\zeta \in \partial\mathbb{D}$ is an element of $\Lambda(\Gamma(z))$ if: there exists $\gamma_n \in \Gamma$ such that $\gamma_n(z) \rightarrow \zeta$ as $n \rightarrow \infty$.

- (ii) By Corollary 24.2.5, we know that for a Fuchsian group Γ any limit point of $\Gamma(z)$ lies on the boundary. Thus $\Lambda(\Gamma(z)) \subset \partial\mathbb{D}$.

It appears from the above definition that the sets $\Lambda(\Gamma(z))$ depend on the choice of point z . This is not the case, as the following result shows.

Proposition 24.3.1

Let Γ be a Fuchsian group and let $z_1, z_2 \in \mathbb{D}$. Then

$$\Lambda(\Gamma(z_1)) = \Lambda(\Gamma(z_2)).$$

Definition. Let Γ be a Fuchsian group acting on the Poincaré disc \mathbb{D} . We define the *limit set* $\Lambda(\Gamma)$ of Γ to be the set $\Lambda(\Gamma(z))$ for any $z \in \mathbb{D}$.

Proof. One can prove that the following formula holds for two points $z_1, z_2 \in \mathbb{D}$:

$$\sinh^2 \frac{1}{2} d_{\mathbb{D}}(z_1, z_2) = \frac{|z_1 - z_2|^2}{(1 - |z_1|^2)(1 - |z_2|^2)}.$$

(Recall that Proposition 5.5.2 gives a formula for $\cosh d_{\mathbb{H}}(z_1, z_2)$ in the upper half-plane. One can prove a similar formula in the Poincaré disc using the same method.)

Let $\gamma \in \Gamma$. As γ is an isometry, it follows that

$$\begin{aligned} \sinh^2 \frac{1}{2} d_{\mathbb{D}}(z_1, z_2) &= \sinh^2 \frac{1}{2} d_{\mathbb{D}}(\gamma(z_1), \gamma(z_2)) \\ &= \frac{|\gamma(z_1) - \gamma(z_2)|^2}{(1 - |\gamma(z_1)|^2)(1 - |\gamma(z_2)|^2)}. \end{aligned}$$

Hence for any $\gamma \in \Gamma$ we have

$$|\gamma(z_1) - \gamma(z_2)| \leq (1 - |\gamma(z_1)|^2)^{1/2} \sinh \frac{1}{2} d_{\mathbb{D}}(z_1, z_2). \tag{24.3.1}$$

Let $\zeta \in \Lambda(\Gamma(z_1))$. We show that $\zeta \in \Lambda(\Gamma(z_2))$.

As $\zeta \in \Lambda(\Gamma(z_1))$, there exists a sequence of group elements $\gamma_n \in \Gamma$ such that $\gamma_n(z_1) \rightarrow \zeta$ as $n \rightarrow \infty$. Consider (24.3.1) for γ_n :

$$|\gamma_n(z_1) - \gamma_n(z_2)| \leq (1 - |\gamma_n(z_1)|^2)^{1/2} \sinh \frac{1}{2} d_{\mathbb{D}}(z_1, z_2). \tag{24.3.2}$$

As $\zeta \in \partial\mathbb{D}$, we have that $|\gamma_n(z_1)| \rightarrow |\zeta| = 1$ as $n \rightarrow \infty$. It follows from (24.3.2) that $\gamma_n(z_2) \rightarrow \zeta$ as $n \rightarrow \infty$. Hence $\zeta \in \Lambda(\Gamma(z_2))$. Thus we have shown that $\Lambda(\Gamma(z_1)) \subset \Lambda(\Gamma(z_2))$.

By reversing z_1 and z_2 in the above argument, we see that $\Lambda(\Gamma(z_2)) \subset \Lambda(\Gamma(z_1))$. Hence $\Lambda(\Gamma(z_1)) = \Lambda(\Gamma(z_2))$. □

Remark. There is, of course, a corresponding notion of limit set in the upper half-plane model of the hyperbolic plane. The definition is as above (with \mathbb{D} replaced by \mathbb{H}), but a small amount of care has to be taken when one defines convergence in $\partial\mathbb{H} = \mathbb{R} \cup \{\infty\}$. Let us make this precise. Suppose that Γ is a Fuchsian group acting on \mathbb{H} and let $z \in \mathbb{H}$. We say that $\zeta \in \mathbb{R} \subset \partial\mathbb{H}$ is a limit point of $\Gamma(z)$ if there exists $\gamma_n \in \Gamma$ such that $|\gamma_n(z) - \zeta| \rightarrow 0$ as $n \rightarrow \infty$. We say that $\infty \in \partial\mathbb{H}$ is a limit point of $\Gamma(z)$ if for all $K > 0$ there exists $\gamma \in \Gamma$ such that $|\gamma(z)| \geq K$.

Recall the map $h : \mathbb{H} \rightarrow \mathbb{D}$ that we used in Lecture 6 to transfer results between the upper half-plane and Poincaré disc models of hyperbolic space. Let $\Gamma < \text{Möb}(\mathbb{H})$ be a Fuchsian group and let $\Lambda_{\mathbb{H}}(\Gamma)$ denote its limit set. Then $h(\Gamma) < \text{Möb}(\mathbb{D})$ is a Fuchsian group in the Poincaré disc model with limit set $\Lambda_{\mathbb{D}}(h(\Gamma)) = h(\Lambda_{\mathbb{H}}(\Gamma))$.

Examples.

- (i) Let us work in the upper half-plane model. Take $\Gamma = \{\gamma_n \mid \gamma_n(z) = 2^n z, n \in \mathbb{Z}\}$. Consider the point $i \in \mathbb{H}$. Then $\gamma_n(i) \rightarrow \infty$ as $n \rightarrow \infty$, and $\gamma_{-n}(i) \rightarrow 0$ as $n \rightarrow \infty$. It is easy to see that $\Lambda(\Gamma) = \{0, \infty\}$.
- (ii) Working again in the upper half-plane model, take Γ to be the modular group $\text{PSL}(2, \mathbb{Z})$. Then $\Lambda(\Gamma) = \partial\mathbb{H}$. We shall see several proofs of this later.

Exercise 24.2

In the upper half-plane, take $\Gamma = \{\gamma_n \mid \gamma_n(z) = z + n, n \in \mathbb{Z}\}$. Find $\Lambda(\Gamma)$.

§24.4 Properties of the limit set

In this section we derive some basic properties of the limit set $\Lambda(\Gamma)$ of a Fuchsian group Γ . More specifically, we shall see that $\Lambda(\Gamma)$ is a compact Γ -invariant subset of $\partial\mathbb{D}$.

§24.4.1 Conjugate Fuchsian groups

Recall that we say that two Möbius transformations $\gamma_1, \gamma_2 \in \text{Möb}(\mathbb{H})$ of \mathbb{H} are *conjugate* if there exists $g \in \text{Möb}(\mathbb{H})$ such that $\gamma_2 = g^{-1}\gamma_1g$. Recall that we think of conjugate Möbius transformations as representing the same transformation but with respect to different co-ordinate systems.

Definition. Let Γ_1 and Γ_2 be Fuchsian groups. We say that Γ_1 and Γ_2 are *conjugate* if there exists $g \in \text{Möb}(\mathbb{H})$ such that

$$\Gamma_2 = g^{-1}\Gamma_1g = \{g^{-1}\gamma_1g \mid \gamma_1 \in \Gamma_1\}.$$

Again, we think of conjugacy as a change of co-ordinates.

The following result relates the limit sets of conjugate Fuchsian groups.

Proposition 24.4.1

Let Γ_1 be a Fuchsian group and let $\Gamma_2 = g^{-1}\Gamma_1g$ be a conjugate Fuchsian group. Then

$$\Lambda(\Gamma_2) = g^{-1}(\Lambda(\Gamma_1)).$$

Proof. Let $\zeta \in \Lambda(\Gamma_1)$. Then there exists $z \in \mathbb{D}$ and a sequence $\gamma_n^{(1)} \in \Gamma_1$ such that $\gamma_n^{(1)}(z) \rightarrow \zeta$ as $n \rightarrow \infty$. Notice that $\gamma_n^{(2)} = g^{-1}\gamma_n^{(1)}g \in \Gamma_2$. Hence

$$\begin{aligned} \gamma_n^{(2)}(g^{-1}z) &= g^{-1}\gamma_n^{(1)}g(g^{-1}z) \\ &= g^{-1}(\gamma_n^{(1)}(z)) \\ &\rightarrow g^{-1}(\zeta) \end{aligned}$$

so that

$$g^{-1}(\Lambda(\Gamma_1)) \subset \Lambda(\Gamma_2).$$

The reverse inequality follows similarly. □

Remark. It follows from Proposition 24.4.1 that if Γ_1 and Γ_2 are conjugate Fuchsian groups then their limit sets $\Lambda(\Gamma_1)$ and $\Lambda(\Gamma_2)$ have the same cardinality. Moreover, they have the same topological properties. This is because the map $\zeta \mapsto g^{-1}(\zeta) : \partial\mathbb{D} \rightarrow \partial\mathbb{D}$ is a homeomorphism. When studying the limit set of a Fuchsian group Γ , it will often simplify the analysis if we replace Γ with a conjugate Fuchsian group $g^{-1}\Gammag$.

§24.4.2 Basic topological properties

Proposition 24.4.2

Let Γ be a Fuchsian group. Then the limit set $\Lambda(\Gamma)$ of Γ is a closed subset of $\partial\mathbb{D}$.

Exercise 24.3

Prove Proposition 24.4.2: namely, show that if $\zeta_n \in \Lambda(\Gamma)$ and $\zeta_n \rightarrow \zeta \in \partial\mathbb{D}$ then $\zeta \in \Lambda(\Gamma)$.

Corollary 24.4.3

The limit set of a Fuchsian group is compact.

Proof. This is immediate from Proposition 24.4.2: $\Lambda(\Gamma)$ is a closed subset of the compact set $\partial\mathbb{D}$ and therefore is itself compact. \square

§24.4.3 The action of Γ on $\Lambda(\Gamma)$.

Recall that a Möbius transformation $\gamma \in \text{Möb}(\mathbb{D})$ of \mathbb{D} also acts on the boundary $\partial\mathbb{D}$. Thus if $\gamma \in \Gamma$ then $\gamma(\Lambda(\Gamma)) = \{\gamma(\zeta) \mid \zeta \in \Lambda(\Gamma)\} \subset \partial\mathbb{D}$.

Proposition 24.4.4

The limit set $\Lambda(\Gamma)$ is invariant under Γ , namely $\gamma(\Lambda(\Gamma)) = \Lambda(\Gamma)$.

Proof. We have to show that for $\gamma \in \Gamma$ we have $\gamma(\Lambda(\Gamma)) = \Lambda(\Gamma)$.

Let $\zeta \in \Lambda(\Gamma)$. Then there exist $\gamma_n \in \Gamma$ such that $\gamma_n(z) \rightarrow \zeta$. Now $\gamma\gamma_n \in \Gamma$ as Γ is a group. Hence $\gamma\gamma_n(z) \rightarrow \gamma(\zeta)$. Hence $\gamma(\zeta) \in \Lambda(\Gamma)$. Thus $\gamma(\Lambda(\Gamma)) \subset \Lambda(\Gamma)$.

By replacing γ by γ^{-1} in the above argument, we can similarly show that $\Lambda(\Gamma) \subset \gamma(\Lambda(\Gamma))$.

Hence $\gamma(\Lambda(\Gamma)) = \Lambda(\Gamma)$. \square

Remark. In fact, one can show that $\Lambda(\Gamma)$ is the *smallest* Γ -invariant subset of $\partial\mathbb{D}$. Namely, if $C \subset \partial\mathbb{D}$ is a Γ -invariant subset then $C \supset \Lambda(\Gamma)$.

§24.4.4 The cardinality of the limit set

We know that if Γ is a Fuchsian group then $\Lambda(\Gamma)$ is a compact subset of $\partial\mathbb{D}$. The purpose of this section is to study the cardinality of $\Lambda(\Gamma)$. We shall show that $\Lambda(\Gamma)$ can have either 0, 1, 2 or infinitely many elements. Later on, we shall see that if $\Lambda(\Gamma)$ is infinite, then it must in fact be uncountable.

We begin with the following result. Recall that if γ is a parabolic or hyperbolic Möbius transformation then γ has either 1 or 2 fixed points in $\Lambda(\Gamma)$. We show that if Γ contains a parabolic or hyperbolic element then the fixed points must lie in $\Lambda(\Gamma)$.

Proposition 24.4.5

Let Γ be a Fuchsian group.

- (i) Suppose that $\gamma \in \Gamma$ is a parabolic Möbius transformation of \mathbb{D} . Then the fixed point $\zeta \in \partial\mathbb{D}$ of γ is an element of $\Lambda(\Gamma)$.
- (ii) Suppose that $\gamma \in \Gamma$ is a hyperbolic Möbius transformation of \mathbb{D} . Then the two fixed points $\zeta_1, \zeta_2 \in \partial\mathbb{D}$ of γ are elements of $\Lambda(\Gamma)$.

Proof. We work in the upper half-plane model \mathbb{H} for convenience. We prove (i). Suppose that $\gamma \in \Gamma$ is parabolic. By Proposition 10.3.1, γ is conjugate to a translation $z \mapsto z + b$, $b \neq 0$. That is, there exists $g \in \text{Möb}(\mathbb{H})$ such that $g^{-1}\gamma g(z) = z + b$. Then

$$g^{-1}\gamma^n g(z) = z + bn \rightarrow \infty \in \partial\mathbb{H}$$

as $n \rightarrow \infty$. Observe that $\zeta = g(\infty)$ is the unique fixed point of γ . Then

$$\gamma^n(g(z)) \rightarrow \zeta$$

as $n \rightarrow \infty$. Hence $\zeta \in \Lambda(\Gamma)$. □

Exercise 24.4

Prove Proposition 24.4.5(ii).

Exercise 24.5

Let $p, q \in \mathbb{Z}$, $q \neq 0$. Consider the Möbius transformation of \mathbb{H}

$$\gamma(z) = \frac{(1 + pq)z - p^2}{q^2z + (1 - pq)}.$$

Show that $\gamma \in \text{PSL}(2, \mathbb{Z})$. By considering the fixed point(s) of γ , show that $\Lambda(\text{PSL}(2, \mathbb{Z})) = \partial\mathbb{H}$.

Proposition 24.4.6

Let Γ be a Fuchsian group and let $\Lambda(\Gamma)$ be its limit set. Then $\Lambda(\Gamma)$ has either 0,1,2 or infinitely many elements.

Proof. Suppose that $\Lambda(\Gamma)$ is finite but has at least 3 elements. We show that this cannot happen. Let C denote the finite collection of geodesics with end-points in $\Lambda(\Gamma)$. As $\Lambda(\Gamma)$

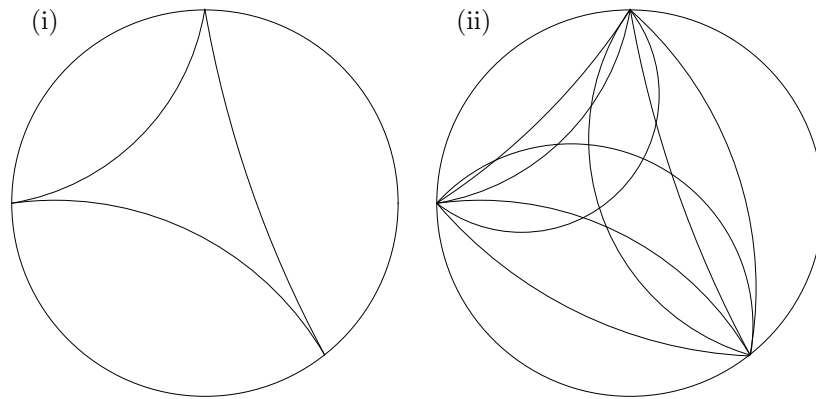

Figure 24.4.1: (i) The set C in the case of 3 points. (ii) The lines show the set of points within distance M of the geodesic; the “triangle” in the middle illustrates the set $C(M)$.

is Γ -invariant, it follows that C is also Γ -invariant. Let $M > 0$ and let $C(M)$ denote the set of points that are within distance M of every geodesic in C :

$$C(M) = \{z \in \mathbb{D} \mid \sup_{L \in C} \inf_{x \in L} d_{\mathbb{D}}(z, x) \leq M\}.$$

Then, as C is Γ -invariant and Γ acts on \mathbb{D} by isometries, we see that $C(M)$ is also Γ -invariant.

By choosing M sufficiently large, we see that $C(M)$ is not empty (draw a picture!). Choose a point $z_0 \in C(M)$.

As $\Lambda(\Gamma)$ has at least three elements, for any $\zeta \in \overline{C(M)} \cap \partial\mathbb{D}$ there exists a geodesic $L \in C$ which does not have ζ as an endpoint.

Let z be a point near ζ . Then as $z \rightarrow \zeta$, we have that $d_{\mathbb{D}}(z, L) = \inf_{x \in L} d_{\mathbb{D}}(z, x) \rightarrow \infty$. Hence $z \notin C(M)$ if z is sufficiently close to ζ . Hence $C(M)$ is a bounded set, and in particular is bounded away from $\partial\mathbb{D}$.

As $z_0 \in C(M)$ and $C(M)$ is Γ -invariant, we must have that the orbit $\Gamma(z_0)$ of z_0 lies in $C(M)$, which is bounded away from $\partial\mathbb{D}$. In particular, the orbit of z_0 cannot have any limit points on the boundary $\partial\mathbb{D}$. But this contradicts the fact that $\Lambda(\Gamma) = \Gamma(z_0) \cap \partial\mathbb{D}$ has at least three points. \square

We can classify Fuchsian groups by the cardinality of their limit sets as follows:

Definition. We say that Γ is *elementary* if $\Lambda(\Gamma)$ has finitely many elements. Otherwise, we say that Γ is *non-elementary*.

Exercise 24.6

Check that all three possibilities can occur: namely, write down examples of Fuchsian groups $\Gamma_0, \Gamma_1, \Gamma_2, \Gamma_\infty$ such that $\Lambda(\Gamma_j)$ has, respectively, 0, 1, 2, ∞ elements. (In a later section we shall classify all Fuchsian groups for which $\Lambda(\Gamma)$ is finite.)

25. Some algebraic properties of Fuchsian groups

§25.1 Cyclic groups

Definition. A group Γ is said to be *cyclic* if there exists $\gamma \in \Gamma$ such that

$$\Gamma = \{\gamma^n \mid n \in \mathbb{Z}\}.$$

We say that γ *generates* Γ , or equivalently that γ is a *generator* for Γ .

Exercise 25.1

Show that any cyclic group is abelian.

Examples.

1. The Fuchsian groups

$$\begin{aligned}\Gamma &= \{\gamma_n(z) = z + n \mid n \in \mathbb{Z}\} \\ \Gamma &= \{\gamma_n(z) = 2^n z \mid n \in \mathbb{Z}\}\end{aligned}$$

are cyclic; the first is generated by $z \mapsto z + 1$ and the second is generated by $z \mapsto 2z$.

2. The Fuchsian group

$$\Gamma = \{\gamma_k(z) = e^{2\pi i k/n} z \mid k = 0, 1, \dots, n-1\}$$

is a cyclic group. It is generated by $z \mapsto e^{2\pi i/n} z$.

In particular, we see that a cyclic group may be finite.

The following easily-proved result says that discrete subgroups of the real line and the circle (both thought of as additive groups) are cyclic.

Lemma 25.1.1

- (i) Any non-trivial discrete subgroup of \mathbb{R} is an infinite cyclic group.
- (ii) Any non-trivial discrete subgroup of the unit circle S^1 is a finite cyclic group.

Exercise 25.2

Prove Lemma 25.1.1. (Hint: Suppose that $\Gamma < \mathbb{R}$ is a discrete subgroup. Choose an element $0 < y \in \Gamma$ such that no other element of Γ lies between 0 and y (why does such an element exist?). Show that y generates Γ .)

§25.2 Centralisers and applications to abelian Fuchsian groups

Definition. Let Γ be a group and let $\gamma \in \Gamma$. The *centraliser* $C_\Gamma(\gamma)$ is the set of all elements in Γ that commute with γ , i.e.

$$C_\Gamma(\gamma) = \{g \in \Gamma \mid g\gamma = \gamma g\}.$$

Thus Γ is abelian if and only if $C_\Gamma(\gamma) = \Gamma$ for all $\gamma \in \Gamma$.

Let $\gamma \in \text{Möb}(\mathbb{H})$ be a Möbius transformation of \mathbb{H} . We are interested in calculating the centraliser $C_{\text{Möb}(\mathbb{H})}(\gamma)$ of γ in $\text{Möb}(\mathbb{H})$. This will allow us to calculate all abelian Fuchsian groups.

Recall that a point $z \in \mathbb{H} \cup \partial\mathbb{H}$ is a fixed point of $\gamma \in \text{Möb}(\mathbb{H})$ if $\gamma(z) = z$.

Lemma 25.2.1

Let $\gamma \in \text{Möb}(\mathbb{H})$ and let $g \in C_{\text{Möb}(\mathbb{H})}(\gamma)$. Then z is a fixed point of γ if and only if $g(z)$ is a fixed point of γ .

Exercise 25.3

Prove Lemma 25.2.1

Let $\gamma \in \text{Möb}(\mathbb{H})$ and let us calculate the centraliser $C_{\text{Möb}(\mathbb{H})}(\gamma)$ of γ in $\text{Möb}(\mathbb{H})$. We consider three cases: γ is parabolic, hyperbolic or elliptic.

Let $\gamma \in \text{Möb}(\mathbb{H})$ be a parabolic Möbius transformation of \mathbb{H} . By replacing γ with a conjugate transformation, we may assume that γ has its unique fixed point at ∞ and is either the translation $\gamma(z) = z + 1$ or $\gamma(z) = z - 1$ (compare with Proposition 10.3.1). We will consider the case when $\gamma(z) = z + 1$; the case when $\gamma(z) = z - 1$ is exactly the same. Let $g \in C_{\text{Möb}(\mathbb{H})}(\gamma)$ commute with γ . By Lemma 25.2.1, $g(\infty) = \infty$. Hence $g(z) = az + b$ (see Lecture 10). Now

$$\begin{aligned} g\gamma(z) &= az + a + b \\ \gamma g(z) &= az + b + 1 \end{aligned}$$

and comparing coefficients shows that $a = 1$. Hence

$$C_{\text{Möb}(\mathbb{H})}(\gamma) = \{g(z) = z + b \mid b \in \mathbb{R}\},$$

the group of all translations.

Exercise 25.4

- (i) Consider the hyperbolic transformation $\gamma(z) = kz$. Show that $C_{\text{Möb}(\mathbb{H})}(\gamma)$ is the set of all dilations $\{\gamma(z) = \lambda z \mid \lambda > 0\}$.
- (ii) Consider the elliptic transformation $\gamma(z) = e^{2\pi i\theta}z$ of \mathbb{D} . Show that $C_{\text{Möb}(\mathbb{D})}(\gamma)$ is the set of all rotations around $0 \in \mathbb{D}$.

Combining the above exercise with Propositions 11.2.1 and 11.3.1, we have the following results.

Proposition 25.2.2

Two Möbius transformations commute if and only if they have the same set of fixed points.

Proposition 25.2.3

- (i) The centraliser $C_{\text{Möb}(\mathbb{H})}(\gamma)$ in $\text{Möb}(\mathbb{H})$ of a parabolic element $\gamma \in \Gamma$ consists of all parabolic transformations with the same fixed point in $\partial\mathbb{H}$ as γ .
- (ii) The centraliser $C_{\text{Möb}(\mathbb{H})}(\gamma)$ in $\text{Möb}(\mathbb{H})$ of an elliptic element $\gamma \in \Gamma$ consists of all elliptic transformations with the same fixed point in \mathbb{H} as γ .
- (i) The centraliser $C_{\text{Möb}(\mathbb{H})}(\gamma)$ in $\text{Möb}(\mathbb{H})$ of a hyperbolic element $\gamma \in \Gamma$ consists of all hyperbolic transformations with the same two fixed points in $\partial\mathbb{H}$ as γ .

The next two results tell us that the only abelian Fuchsian groups are cyclic.

Proposition 25.2.4

Let Γ be a Fuchsian group. Suppose that every element $\gamma \in \Gamma \setminus \{\text{Id}\}$ has the same set of fixed points. Then Γ is cyclic.

Proof. As every non-identity element of Γ has the same set of fixed points, all non-identity elements must be of the same type: they must either be all parabolic, all elliptic or all hyperbolic.

Suppose that Γ contains only parabolic elements that fix the same element, together with the identity. Replace Γ with a conjugate subgroup so that the fixed point is ∞ . The only transformations that fix have ∞ as the unique fixed point are the translations. Hence Γ is a discrete subgroup of the group of translations $\{z \mapsto z + b, b \in \mathbb{R}\}$, which is isomorphic to \mathbb{R} . By Lemma 25.1.1, Γ is cyclic.

Suppose that all the non-identity elements of Γ are hyperbolic and have the same set of fixed points. By replacing Γ by a conjugate group, we may assume that the fixed points are 0 and ∞ . The only transformations that fix both 0 and ∞ are the dilations $z \mapsto kz$. Hence Γ is a discrete subgroup of the group of all dilations $\{z \mapsto kz \mid k > 0\}$, i.e. the multiplicative group of positive reals. The multiplicative group of positive reals is isomorphic to the additive group of reals (via the isomorphism $x \mapsto \log x$). By Lemma 25.1.1, Γ is cyclic.

Working in \mathbb{D} , suppose that Γ contains only elliptic elements that fix the same element. Replace Γ with a conjugate subgroup so that the fixed point is $0 \in \mathbb{D}$. The only transformations that fix only 0 are the rotations. Hence Γ is a discrete subgroup of the group of rotations $\{z \mapsto e^{2\pi i\theta} z, \theta \in [0, 1)\}$, which is isomorphic to the unit circle. By Lemma 25.1.1, Γ is cyclic. \square

Proposition 25.2.5

Let Γ be an abelian Fuchsian group. Then Γ is cyclic.

Proof. Let Γ be an abelian Fuchsian group. Then by Proposition 25.2.2 every element has the same set of fixed points. By Proposition 25.2.4 it follows that Γ is cyclic. \square

Corollary 25.2.6

No Fuchsian group is isomorphic to the additive group $\mathbb{Z}^2 = \{(n, m) \mid n, m \in \mathbb{Z}\}$.

Proof. The group \mathbb{Z}^2 is abelian but not cyclic. \square

Exercise 25.5

Let Γ be a group and let $H < \Gamma$ be a subgroup. We define

$$N_{\Gamma}(H) = \{g \in \Gamma \mid gHg^{-1} = H\}$$

to be the *normaliser* of H in Γ . That is, the normaliser of H is the largest subgroup of Γ in which H is a normal subgroup.

- (i) Check that $N_\Gamma(H)$ is a subgroup of Γ .
- (ii) Let $\Gamma < \text{Möb}(\mathbb{H})$ be a non-abelian Fuchsian group. Prove that $N_{\text{Möb}(\mathbb{H})}(\Gamma)$ is also a Fuchsian group.
(Hint: Suppose not. Consider a sequence of elements of $N_{\text{Möb}(\mathbb{H})}(\Gamma)$ that converges to the identity.)

26. Classifying elementary Fuchsian groups

We have seen that if Γ is a Fuchsian group then $\Lambda(\Gamma)$ can have either 0, 1, 2 or infinitely many elements. In this section we shall classify precisely those Fuchsian groups which have a finite limit set.

§26.1 The case when $\text{card } \Lambda(\Gamma) = 0$

Here we analyse the case when $\Lambda(\Gamma) = \emptyset$. We shall show that this happens if and only if Γ is a cyclic group generated by an elliptic element. We need the following preparatory result.

Proposition 26.1.1

Let Γ be a Fuchsian group. Suppose that all elements of Γ , other than the identity, are elliptic. Then all the elliptic transformations have a common fixed point.

Proof. Let $\gamma \in \Gamma \setminus \{\text{Id}\}$ be elliptic. Then γ has a unique fixed point $z \in \mathbb{H}$. To prove the theorem we have to show that every element of Γ has the same fixed point.

We work in the Poincaré disc \mathbb{D} . Let $\gamma \in \Gamma \setminus \{\text{Id}\}$. Then γ has a unique fixed point in \mathbb{D} . By replacing Γ with a conjugate group, we can assume that this fixed point occurs at 0. Then γ has matrix

$$\begin{pmatrix} \alpha & 0 \\ 0 & \bar{\alpha} \end{pmatrix}$$

with $|\alpha| = 1$.

Let $g \in \Gamma$, $g \neq \gamma$. We show that g also has a fixed point at 0. Let g have matrix

$$\begin{pmatrix} \alpha' & \beta' \\ \bar{\beta}' & \bar{\alpha}' \end{pmatrix}$$

with $\alpha', \beta' \in \mathbb{C}$, $|\alpha'|^2 - |\beta'|^2 = 1$.

Consider the commutator $[\gamma, g] = \gamma g \gamma^{-1} g^{-1} \in \Gamma$. A straightforward calculation shows that this has matrix

$$\begin{pmatrix} |\alpha|^2 |\alpha'|^2 - \alpha^2 |\beta'|^2 & \alpha^2 \alpha' \beta' - |\alpha|^2 \alpha' \beta' \\ \bar{\alpha}^2 \bar{\alpha}' \bar{\beta}' - |\alpha|^2 \bar{\alpha}' \bar{\beta}' & |\alpha|^2 |\alpha'|^2 - \bar{\alpha}^2 |\beta'|^2 \end{pmatrix}.$$

Recalling that $|\alpha| = 1$, the trace of $[\gamma, g]$ is given by the square of:

$$|\alpha'|^2 - \alpha^2 |\beta'|^2 + |\alpha'|^2 - \bar{\alpha}^2 |\beta'|^2.$$

As $|\alpha'|^2 - |\beta'|^2 = 1$, we see that the trace of $[\gamma, g]$ is the square of

$$2 + |\beta'|^2 (-\alpha^2 + 2 - \bar{\alpha}^2) = 2 - |\beta'|^2 (\alpha - \bar{\alpha})^2.$$

Recall that $\alpha - \bar{\alpha} = 2i \text{Im}(\alpha)$. Hence, the trace of $[\gamma, g]$ is the square of

$$2 + 4|\beta'|^2 (\text{Im}(\alpha))^2.$$

As Γ does not contain any hyperbolic elements and $[\gamma, g] \in \Gamma$, we must have that $[\gamma, g]$ is not hyperbolic. In particular, the trace of $[\gamma, g]$ is at most 4. Squaring the above quantity, we see that this can only happen if either $\text{Im}(\alpha) = 0$ or $\beta' = 0$.

If $\text{Im}(\alpha) = 0$ then $\alpha = \bar{\alpha}$ so that γ is equal to the identity, a contradiction. Hence $\beta' = 0$, so that g fixes the point 0. Hence every element of Γ has the same fixed point. \square

Corollary 26.1.2

Suppose that all elements of Γ , other than the identity, are elliptic. Then the limit set $\Lambda(\Gamma)$ is empty.

Proof. By Proposition 26.1.1 we know that there exists a common fixed point $z \in \mathbb{D}$ such that $\gamma(z) = z$ for all $\gamma \in \Gamma$. Hence the orbit of z under Γ is equal to $\{z\}$. Hence $\Lambda(\Gamma) = \emptyset$. \square

The converse to Corollary 26.1.2 is true.

Corollary 26.1.3

Let Γ be a Fuchsian group and suppose that $\Lambda(\Gamma) = \emptyset$. Then Γ is a cyclic abelian group generated by an elliptic element.

Proof. This is merely assembling facts that we have already proved in the correct order!

Suppose that $\Lambda(\Gamma) = \emptyset$. By Proposition 24.4.5, Γ contains only elliptic elements and the identity. By Proposition 26.1.1, there exists a common fixed point. By replacing Γ by a conjugate group, we can assume that this fixed point is the origin. Hence each element of Γ is of the form $z \mapsto e^{2\pi i\theta} z$, and so can be viewed as a subgroup of the circle. By Lemma 25.1.1, it follows that Γ is a finite cyclic group. \square

§26.2 The case when $\text{card } \Lambda(\Gamma) = 1$

Here we analyse the case when $\Lambda(\Gamma)$ has exactly one element. We shall show that this happens if and only if Γ is an infinite cyclic group generated by a parabolic element.

Proposition 26.2.1

Let Γ be a Fuchsian group and suppose that $\Lambda(\Gamma) = \{\zeta\}$. Then Γ is of the form

$$\Gamma = \{\gamma^n \mid n \in \mathbb{Z}\},$$

for some parabolic $\gamma \in \Gamma$, i.e. Γ is an infinite cyclic group generated by a parabolic transformation.

Proof. Let Γ be a Fuchsian group and suppose that the limit set $\Lambda(\Gamma)$ contains only a single element $\zeta \in \partial\mathbb{D}$. By Theorem 24.4.4 we know that $\Lambda(\Gamma)$ is Γ -invariant. Hence if $\gamma \in \Gamma$ then we have that $\gamma(\zeta) = \zeta$. Thus each element of Γ fixes ζ . In particular, this implies that there are no elliptic transformations in Γ .

We show that Γ does not contain a hyperbolic element. Recall that a hyperbolic Möbius transformation of \mathbb{D} has two fixed points in $\partial\mathbb{D}$ and that these fixed points lie in $\Lambda(\Gamma)$. As we are assuming that $\Lambda(\Gamma)$ contains only one point, this cannot happen.

Hence Γ contains only parabolic elements and the identity. By working in the upper half-plane and replacing Γ by a conjugate subgroup, we may assume that $\Lambda(\Gamma) = \{\infty\} \subset \partial\mathbb{H}$. The only parabolic Möbius transformations of \mathbb{H} that have ∞ as a fixed point are

translations of the form $z \mapsto z + b$ for some $b \in \mathbb{R}$. Hence Γ is (conjugate to) a subgroup of $\{z \mapsto z + b \mid b \in \mathbb{R}\}$ which is isomorphic to \mathbb{R} . By Lemma 25.1.1, it follows that Γ is a cyclic abelian group generated by a parabolic Möbius transformation of \mathbb{H} . \square

Exercise 26.1

Prove the converse to Proposition 26.2.1, namely that if Γ is an infinite cyclic group generated by a parabolic element then $\Lambda(\Gamma)$ has one element.

§26.3 The case when $\text{card } \Lambda(\Gamma) = 2$

Finally, suppose that $\Lambda(\Gamma)$ has two elements. Indeed, let $\Lambda(\Gamma) = \{\zeta_1, \zeta_2\}$. Recall that Γ acts on $\Lambda(\Gamma)$. Hence each element of Γ maps ζ_1 to either ζ_1 or to ζ_2 , and similarly ζ_2 is mapped to either ζ_2 or to ζ_1 . This observation allows us to classify Fuchsian groups Γ for which the limit set $\Lambda(\Gamma)$ contains two elements.

Proposition 26.3.1

Let Γ be a Fuchsian group and suppose that $\Lambda(\Gamma)$ has two points. Then either

- (i) Γ is an infinite cyclic group generated by a hyperbolic transformation, or
- (ii) Γ is conjugate to a Fuchsian group generated by

$$z \mapsto kz, z \mapsto -\frac{1}{z}$$

for some $k > 1$.

Proof. Let $\Lambda(\Gamma) = \{\zeta_1, \zeta_2\}$. There are two cases.

Case 1. Suppose that $\gamma(\zeta_1) = \zeta_1$ for all $\gamma \in \Gamma$. Then $\gamma(\zeta_2) = \zeta_2$ for all $\gamma \in \Gamma$. Hence each $\gamma \in \Gamma$ fixes both ζ_1 and ζ_2 ; therefore each element of Γ is hyperbolic. By replacing Γ by a conjugate subgroup, we may assume that $\zeta_1 = 0$, $\zeta_2 = \infty$. A hyperbolic transformation that fixes 0 and ∞ is of the form $z \mapsto kz$ for some $k \in \mathbb{R}$. Hence Γ is conjugate to a subgroup of the form $\{z \mapsto kz \mid k \in \mathbb{R}\}$, which is isomorphic to \mathbb{R} . By Lemma 25.1.1, it follows that Γ is an infinite cyclic group generated by a hyperbolic element.

Case 2. Now suppose that there exists $\gamma \in \Gamma$ such that $\gamma(\zeta_1) = \zeta_2$.

In this case, each element of Γ either fixes both ζ_1 and ζ_2 or interchanges them. If $\gamma \in \Gamma$ fixes both ζ_1 and ζ_2 then γ is hyperbolic.

Suppose that $\gamma \in \Gamma$ interchanges ζ_1 and ζ_2 . Then ζ_1, ζ_2 are not fixed points of γ . If γ were hyperbolic or parabolic then γ would have at least one fixed point in $\partial\mathbb{D}$ not equal to ζ_1 or ζ_2 and this fixed point would lie in $\Lambda(\Gamma)$. This is a contradiction. Hence γ must be elliptic.

By working in the upper half-plane model and replacing Γ with a conjugate subgroup, we may assume that $\zeta_1 = 0$ and $\zeta_2 = \infty$. Hence any hyperbolic element $\gamma \in \Gamma$ is of the form $z \mapsto kz$ and any elliptic element is of the form $z \mapsto -1/z$. \square

27. Non-elementary Fuchsian groups

We have seen that a Fuchsian group has either 0, 1, 2 or infinitely many elements in its limit set. In this section we briefly discuss the case where the limit set is infinite. The following result says that in this case the limit set is in fact uncountable.

Theorem 27.0.2

Let Γ be a Fuchsian group. Then $\Lambda(\Gamma)$ has either 0,1,2 or uncountably many elements.

Proof. Omitted. See Katok's book. □

Recall that a Fuchsian group Γ is said to be *non-elementary* if the limit set $\Lambda(\Gamma)$ contains infinitely many (equivalently, uncountably many) elements.

Exercise 27.1

Suppose that Γ is a non-elementary Fuchsian group. Prove that Γ must contain a hyperbolic element.

(Hints: First argue that, apart from the identity, either Γ contains only hyperbolic elements (in which case the statement follows trivially) or that it contains a parabolic element. By replacing Γ by a conjugate subgroup, we can assume that a parabolic element γ_1 has ∞ as a fixed point and so has the form $z \mapsto z + b$. If γ_2 is another element of Γ , consider $\tau(\gamma_2\gamma_1^n)$ for large n .)

Before we can discuss the structure of a non-elementary Fuchsian group further, we need the following topological concepts.

Definition. Let (X, d) be a metric space. A subset $Y \subset X$ is said to be *perfect* if it is closed and every point of Y is a limit point of Y .

Definition. Let (X, d) be a metric space. A subset $Y \subset X$ is said to be *nowhere dense* if $X \setminus \text{cl}Y$ is dense, *i.e.* the complement of the closure of Y is dense.

Remarks.

- (i) If Y is already a closed set, then Y is nowhere dense if and only if the complement $X \setminus Y$ is dense.
- (ii) One can often think of nowhere dense sets as sets that are 'topologically small' in the same way that sets of measure zero are 'measure-theoretically' small. (However, the two notions are independent in the sense that there are nowhere dense subsets of $[0, 1]$ that have Lebesgue measure 1.)

Examples.

- (i) Let $X = \mathbb{R}$ and take $Y = \{1/n \mid n \in \mathbb{N}\} \cup \{0\}$. Then $\Lambda(Y) = \{0\}$ so that Y is not perfect.

- (iii) The middle-third Cantor set (the definition of which is given below) is a perfect subset of \mathbb{R} .

A non-elementary Fuchsian group has uncountably many elements. For example, the modular group has limit set equal to the entire boundary, which is clearly uncountable. The following result says that there are essentially two types of behaviour: either the limit set is the entire boundary, or it is a Cantor set. A *Cantor set* is defined to be a perfect nowhere dense subset of a metric space. The most well-known example of a Cantor set is the middle-third Cantor set C . The middle third Cantor set is defined by starting with the unit interval $[0, 1]$ and removing the middle third interval leaving the set $C_1 = [0, 1/3] \cup [2/3, 1]$; these two intervals then have their middle thirds removed, leaving four sub-intervals C_2 . Inductively, this is repeated so that C_n is obtained from C_{n-1} by removing the middle thirds of the 2^n intervals comprising C_{n-1} . Then $C = \bigcap_{n=1}^{\infty} C_n$.

Theorem 27.0.3

Let Γ be a Fuchsian group and suppose that $\Lambda(\Gamma)$ is infinite. Then either

- (i) $\Lambda(\Gamma) = \partial\mathbb{D}$, or
(ii) $\Lambda(\Gamma)$ is a perfect, nowhere dense subset of $\partial\mathbb{D}$.

Proof. Omitted. See Katok's book. □

§27.1 Fuchsian groups of the first and second kind

Let Γ be a Fuchsian group with limit set $\Lambda(\Gamma)$. Then heuristically there are two cases: either $\Lambda(\Gamma)$ is 'big' and is equal to $\partial\mathbb{D}$, or else $\Lambda(\Gamma)$ is 'small' and has either 0,1,2 elements or is a Cantor set.

Definition. Let Γ be a Fuchsian group. We say that Γ is a *Fuchsian group of the first kind* if $\Lambda(\Gamma) = \partial\mathbb{D}$. Otherwise we say that Γ is a *Fuchsian group of the second kind*.

Remark. In particular, if Γ is an elementary Fuchsian group then Γ is of the second kind. However, there are many other examples of non-elementary Fuchsian groups that are of the second kind.

§27.2 Fuchsian groups of the first kind

Recall that a Fuchsian group is said to be of the first kind if its limit set is equal to the whole of the boundary of \mathbb{D} .

Recall also the notion of a fundamental domain. We say that an open subset $F \subset \mathbb{H}$ is a *fundamental domain* for a Fuchsian group Γ if

- (i) $\bigcup_{\gamma \in \Gamma} \gamma(\text{cl}(F)) = \mathbb{H}$,
(ii) the images $\gamma(F)$ are pairwise disjoint; that is, $\gamma_1(F) \cap \gamma_2(F) = \emptyset$ if $\gamma_1 \neq \gamma_2$.

We saw in Lecture 15 that every Fuchsian group has a fundamental domain. Indeed we gave a method for constructing a fundamental domain, namely the Dirichlet polygon. Also, recall Proposition 13.2.1; this says that any two fundamental domains have the same hyperbolic area.

In this section, we state two theorems that essentially say that a Fuchsian group is of the first kind if and only if a (hence all) fundamental domain has finite area. For the first theorem we need to make an additional technical assumption that the group Γ is *geometrically finite*; this means that the Dirichlet polygon has finitely many sides.

Theorem 27.2.1

Let Γ be a (geometrically finite) Fuchsian group of the first kind. Then Γ has a fundamental domain of finite hyperbolic area.

The converse to this theorem (which does not need the assumption of the group being geometrically finite) gives us another method for calculating limit sets.

Theorem 27.2.2

Let Γ be a Fuchsian group. Suppose that there exists a fundamental domain with finite hyperbolic area. Then Γ is a Fuchsian group of the first kind.

Example. Consider the modular group $\text{PSL}(2, \mathbb{Z})$. One fundamental domain for this group is the hyperbolic triangle with vertices at ∞ , $(\pm 1 + i\sqrt{3})/2$. By the Gauss-Bonnet Theorem this has finite hyperbolic area $\pi/3$ (the internal angles are respectively $0, \pi/3, \pi/3$). By Theorem 27.2.2, we see that the limit set $\Lambda(\text{PSL}(2, \mathbb{Z}))$ of the modular group is equal to $\partial\mathbb{H}$.

§27.3 Fuchsian groups of the second kind

Recall that a Fuchsian group is said to be of the second kind if it is not of the first kind! This means that the limit set is not equal to the entire boundary $\partial\mathbb{H}$. There are two possibilities:

- (i) $\Lambda(\Gamma)$ is a finite set, that is Γ is an elementary group, or
- (ii) $\Lambda(\Gamma)$ is a Cantor set, namely a perfect, nowhere dense subset of $\partial\mathbb{H}$.

We can use a version of Poincaré's Theorem to generate examples of Fuchsian groups which have Cantor sets as their limit sets. Recall from Lectures 20 and 21 that Poincaré's Theorem has the following form. We have a hyperbolic polygon D equipped with a set of side-pairing transformations and we assume that D has no free edges, i.e. no arcs of $\partial\mathbb{H}$ form a side of D . We can then calculate the elliptic cycles and parabolic cycles. Poincaré's Theorem says that if each elliptic cycle satisfies the elliptic cycle condition and each parabolic cycle satisfies the parabolic cycle condition then the side-pairing transformations generate a Fuchsian group Γ which has D as a fundamental domain.

We will need a version of Poincaré's Theorem that generalises the above to the cases where we include the possibilities that

- (i) the polygon is allowed to have free edges, and
- (ii) the side-pairing transformations could be arbitrary isometries (and not just Möbius transformations).

Before stating this version of Poincaré's Theorem, let us digress and discuss the group of *all* isometries of \mathbb{H} . Consider the map $\gamma(z) = -\bar{z}$ defined on \mathbb{H} ; this is a reflection in the imaginary axis. It is easy to check from the definition of hyperbolic length that γ is an isometry. However, it is not a Möbius transformation. Note that γ reverses orientation.

In general, a reflection in any geodesic is an isometry. One can prove the following facts (see Beardon, for example):

- (i) The composition of two reflections in two different geodesics is a Möbius transformation. (Indeed, the composition is elliptic, parabolic or hyperbolic if and only if the two geodesics intersect in \mathbb{D} , intersect in $\partial\mathbb{D}$, or are disjoint, respectively.)
- (ii) The group of orientation preserving isometries is precisely the set of Möbius transformations.
- (iii) The set of orientation reversing isometries is precisely the set given by composition of a reflection in a geodesic with a Möbius transformation (which could be the identity).
- (iv) We let

$$\text{Isom}(\mathbb{D}) = \{\text{all isometries of } \mathbb{D}\}$$

denote the group of all isometries of \mathbb{D} . Then $\text{Möb}(\mathbb{D})$ is a subgroup of index 2 in $\text{Isom}(\mathbb{D})$.

Let D be a convex hyperbolic polygon, possibly with free edges. We assume that each side s of D is equipped with a side-pairing transformation γ_s . Here we will allow *any* isometry of \mathbb{H} to be a side-pairing transformation; in particular, we allow side-pairing transformations to be orientation reversing (for example, a reflection in a geodesic). We will also require the isometry γ_s to act in such a way that, locally, the half-plane bounded by s containing D is mapped by γ_s to the half-plane bounded by $\gamma_s(s)$ but opposite D . We assume that each free edge is paired with itself by the identity map. Given a vertex and a side with an end-point at that vertex, we can follow the procedure described in Lecture 18 and Lecture 21 to construct a cycle of vertices and an associated cycle transformation. We say that

- (i) a vertex $v \in \mathbb{H}$ belongs to an *elliptic cycle* (which we calculate as in Lecture 18),
- (ii) a vertex $v \in \partial\mathbb{H}$ belongs to a *parabolic cycle* if the parabolic cycle constructed in Lecture 21 does not contain a vertex that is the end-point of a free edge,
- (iii) a vertex $v \in \partial\mathbb{H}$ belongs to a *free cycle* if the parabolic cycle constructed in Lecture 21 does contain a vertex that is the end-point of a free edge.

If v is a vertex and s is a side with an end-point at v , then we denote the corresponding cycle transformation by $\gamma_{v,s}$. This is a composition of orientation preserving isometries (i.e. Möbius transformations) and orientation reversing isometries (i.e. the composition of a Möbius transformation with a reflection in a geodesic). One can easily check that if v is a vertex on either an elliptic or parabolic cycle then $\gamma_{v,s}$ contains an even number of orientation reversing isometries; hence $\gamma_{v,s}$ is orientation preserving, i.e. a Möbius transformation.

We state the following form of Poincaré's Theorem.

Theorem 27.3.1 (Poincaré's Theorem in the case of free edges)

Let D be a convex hyperbolic polygon, possibly with free edges. Suppose that D is equipped with a collection \mathcal{G} of side-pairing hyperbolic isometries, possibly orientation reversing. Suppose that each free edge is paired with itself via the identity. Suppose that

- (i) *each elliptic cycle satisfies the elliptic cycle condition, and*

(ii) each parabolic cycle satisfies the parabolic cycle condition.

Then the subgroup $\langle \mathcal{G} \rangle$ generated by \mathcal{G} is a discrete subgroup of $\text{Isom}(\mathbb{H})$.

Remarks.

1. If the side-pairing transformations are Möbius transformations, then D is again a fundamental domain for $\langle \mathcal{G} \rangle$.

Suppose that some of the side-pairing transformations are orientation reversing isometries. Then the set $\Gamma_0 = \langle \mathcal{G} \rangle \cap \text{Möb}(\mathbb{H})$ of all orientation preserving transformations in $\langle \mathcal{G} \rangle$ is a Fuchsian group. We can find a fundamental domain for Γ_0 as follows: Let $\gamma \in \langle \mathcal{G} \rangle$ be any orientation reversing isometry. Then $D_0 = D \cup \gamma(D)$ is a fundamental domain for Γ_0 .

2. Suppose that all vertices lie on the boundary and every vertex is the end-point of a free edge. Then, as every vertex must belong to a free cycle, the side-pairing transformations generate a discrete subgroup Γ of $\text{Isom}(\mathbb{H})$. Again, the group $\Gamma_0 = \Gamma \cap \text{Möb}(\mathbb{H})$ of all orientation preserving elements of Γ is a Fuchsian group.

Example. Consider the hyperbolic quadrilateral Q pictured in Figure 27.3. Let γ_1 be

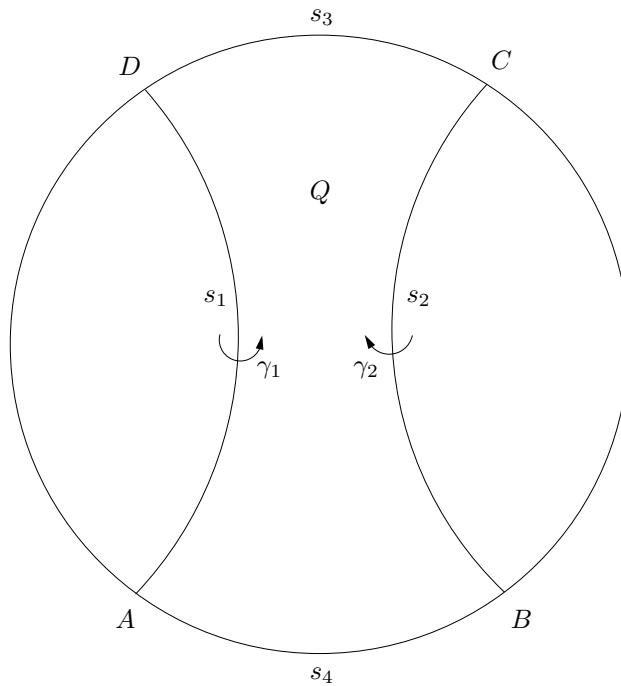

Figure 27.3.1: The side $[A, D]$ is paired to itself by a hyperbolic transformation followed by a reflection; as is the side $[B, C]$

the orientation reversing isometry given by the composition of a hyperbolic transformation with fixed points at $A, D \in \partial\mathbb{D}$ with a reflection in the geodesic $[A, D]$. Then γ_1 pairs the side $[A, D]$ to itself, and maps the half-plane determined by $[A, D]$ that contains Q to the half-plane opposite Q . Thus γ_1 is a side-pairing transformation. Similarly, we take γ_2 to be the composition of a hyperbolic transformation with fixed points at $B, C \in \partial\mathbb{D}$ and a

reflection in the geodesic $[B, C]$; then γ_2 is also a side-pairing transformation that pairs the side $[B, C]$ with itself.

The cycle containing the vertex A is given by:

$$\begin{array}{ccc} \begin{pmatrix} A \\ s_1 \end{pmatrix} & \xrightarrow{\gamma_1} & \begin{pmatrix} A \\ s_1 \end{pmatrix} \xrightarrow{*} \begin{pmatrix} A \\ s_4 \end{pmatrix} \\ & \xrightarrow{\text{id}} & \begin{pmatrix} A \\ s_4 \end{pmatrix} \xrightarrow{*} \begin{pmatrix} A \\ s_1 \end{pmatrix}. \end{array}$$

As this contains the free edge s_4 , this is a free cycle. Similarly, the vertices B, C, D all belong to free cycles. Hence there are no elliptic cycles and no parabolic cycles. By Poincaré’s Theorem, γ_1, γ_2 generate a discrete subgroup of $\text{Isom}(\mathbb{D})$.

Let $\Gamma = \langle \gamma_1, \gamma_2 \rangle \cap \text{Möb}(\mathbb{D})$ denote the subgroup of Möbius transformations in $\langle \gamma_1, \gamma_2 \rangle$. Then Γ is a Fuchsian group. By the first remark above, there is a fundamental domain D_0 for Γ that contains Q . As Q has infinite area, we see that D_0 also has infinite area. Hence Γ must be a Fuchsian group of the second kind. Hence $\Lambda(\Gamma)$ has either 0, 1, 2 elements or is a Cantor set.

Now Γ contains the hyperbolic Möbius transformation γ_1^2 ; this has fixed points at A and D . Hence $A, D \in \Lambda(\Gamma)$. Similarly, Γ contains the hyperbolic Möbius transformation γ_2^2 which has fixed points at B, C ; hence $B, C \in \Lambda(\Gamma)$. Hence $\Lambda(\Gamma)$ contains at least four points. Hence $\Lambda(\Gamma)$ is a Cantor set.

Example. Here is a specific example related to the above construction. Let

$$\gamma_1(z) = 4z, \quad \gamma_2(z) = \frac{7z - 6}{3z - 2}.$$

We claim that γ_1, γ_2 generate a Fuchsian group with a Cantor set as its limit set.

To see this, first observe that γ_1 has fixed points at $0, \infty$ and that γ_2 has fixed points at $1, 2$. Thus the limit set of the group $\Gamma = \langle \gamma_1, \gamma_2 \rangle$ generated by γ_1, γ_2 contains at least 4 points, hence it contains uncountably many points. It remains to check that Γ is a Fuchsian group of the second kind.

Define

$$\gamma_3(z) = 2z, \quad \gamma_4(z) = \frac{3z - 2}{z}$$

and observe that $\gamma_3^2 = \gamma_1$ and $\gamma_4^2 = \gamma_2$. Let σ_1 denote the reflection in the imaginary axis, and let σ_2 denote the reflection in the geodesic $[1, 2]$. Let $\gamma_5 = \sigma_1\gamma_3$, $\gamma_6 = \sigma_2\gamma_4$. Then γ_5 and γ_6 satisfy the hypotheses of the previous example. Therefore γ_5 and γ_6 generate a discrete subgroup $\langle \gamma_5, \gamma_6 \rangle$ of $\text{Isom}(\mathbb{H})$.

It is straightforward to see that $\gamma_5^2 = \gamma_1$ and $\gamma_6^2 = \gamma_2$. Hence the subgroup $\Gamma = \langle \gamma_1, \gamma_2 \rangle$ is a subgroup of $\langle \gamma_5, \gamma_6 \rangle$. As $\langle \gamma_5, \gamma_6 \rangle$ is discrete, Γ must be discrete. As Γ consists of Möbius transformations, Γ is a Fuchsian group.

Finally, observe that the hyperbolic quadrilateral Q with vertices at $0, 1, 2, \infty$ and free edges between vertices $0, 1$ and $2, \infty$ has infinite hyperbolic area. Moreover, Q is contained in a fundamental domain D for $\langle \gamma_5, \gamma_6 \rangle \cap \text{Möb}(\mathbb{H})$. Hence D also has infinite hyperbolic area. As Γ is a subgroup of $\langle \gamma_5, \gamma_6 \rangle \cap \text{Möb}(\mathbb{H})$, one can see (see Proposition 13.2.2) that any fundamental domain for Γ must also have infinite area (indeed, Γ has index 2 in $\langle \gamma_5, \gamma_6 \rangle \cap \text{Möb}(\mathbb{H})$). Hence by Theorem 27.2.1, Γ is a Fuchsian group of the second kind.

§27.3.1 Further developments

There are many other results regarding Fuchsian groups and their limit sets that one can go on to study. For example, if Γ is a Fuchsian group of the second kind with an uncountable limit set $\Lambda(\Gamma)$, then it is a Cantor set (namely, a perfect, nowhere dense subset). One can show that in this case $\Lambda(\Gamma)$ has an extremely complicated structure; indeed it is a fractal set. Recall that one way of defining a fractal set is as a set with a non-integer dimension (the dimension of a point is 0, the dimension of a line is 1, etc). One way of associating a 'dimension' to this set is via its Hausdorff dimension. One can give an explicit formula for the Hausdorff dimension of the limit set.

28. Where we could go next

§28.1 Final remarks about the course

Below are some remarks about which parts of the course are examinable:

- Anything covered in the lectures is examinable.
- The exercises are examinable, apart from those that are explicitly stated as being non-examinable. I've indicated which exercises are particularly important. The exercises (including those that are deemed important) may change from one year to the next.
- There are some topics covered in the lecture notes that I either skimmed over very briefly in the lectures or omitted completely; these (together with any exercises on these topics) are not examinable. Again, which topics are omitted may change from one year to the next.
- The statements of all the major theorems and propositions that I covered in the lectures are examinable, as are their proofs.
- There are several past exam papers on the course website; this year's exam is similar in spirit to previous years'. Section A contains four compulsory short-answer questions worth a total of 40 marks. Section B contains three longer questions each worth 30 marks, of which you must do two. The 15-credit exam contains an extra Section C, containing three questions worth 50 marks in total.
- There is a .pdf file on the course webpage which gives a non-exhaustive list of commonly-made mistakes in the exam in previous years. Please read this and don't make the same mistakes yourself!

Finally, none of the material covered in this lecture is examinable!

§28.2 Compact surfaces

In Lecture 22 we saw how, given $g \geq 2$, we could construct a Fuchsian group Γ such that \mathbb{H}/Γ is a torus of genus g (i.e. we constructed a Fuchsian group with signature $(g, -)$). Thus we can generate a large number of surfaces using hyperbolic geometry. The following two theorems say that, in some sense, most surfaces arise from hyperbolic geometry. Below, you may think of 'compact' as meaning 'closed and bounded'. Moreover, the boundary of the surface can be thought of as its 'edge'; thus the cylinder $[0, 1] \times S^1$ has a boundary (the two circles at the ends), whereas a torus does not have a boundary.

Theorem 28.2.1 (Möbius Classification Theorem (1863))

Let S be a compact orientable surface and suppose that S does not have a boundary. Then S is either:

- (i) a sphere,
- (ii) a torus of genus 1, or
- (iii) a torus of genus g , $g \geq 2$.

In particular, all but two compact orientable surfaces without boundary arise from hyperbolic geometry.

You may have met curvature in other courses, such as Differential Geometry. Curvature measures the extent to which space is curved, and in which direction it is curved. The following, known as Diquet's formula, gives a formula for the curvature of a surface at a point. We define

$$\kappa(x) = \lim_{r \rightarrow 0} \frac{12}{\pi} \left(\frac{\pi r^2 - \text{Area}(B(x, r))}{r^4} \right)$$

where $B(x, r) = \{y \in S \mid d(x, y) < r\}$ denotes a ball of radius r in S . Then one can see that (with the usual notion of distance) a sphere has curvature $+1$, a torus of genus 1 has curvature 0, etc. The following theorem gives a more precise description of all surfaces with constant curvature.

Theorem 28.2.2 (Poincaré-Koebe Uniformisation Theorem (1882, 1907))

Let S be a compact orientable surface of constant curvature and without boundary. Then there exists a covering space M with a suitable distance function and a discrete group of isometries Γ of M such that S is homeomorphic to M/Γ . Moreover,

- (i) if S has positive curvature then M is a sphere,
- (ii) if S has zero curvature then M is the plane \mathbb{R}^2 ,
- (iii) if S has negative curvature then M is the hyperbolic plane \mathbb{H} .

The generalisation of this result to studying 3-dimensional 'surfaces' is called the Thurston Uniformisation Conjecture. It is an important open problem in mathematics that is a topic of major current research interest.

§28.3 Higher-dimensional hyperbolic space

Throughout this course we have studied the hyperbolic plane. Thus we have studied two-dimensional hyperbolic geometry. We could go on to study higher-dimensional hyperbolic geometry.

We can define n -dimensional hyperbolic space as follows. Let

$$\mathbb{H}^n = \{(x_1, x_2, \dots, x_n) \mid x_n > 0\}$$

and let

$$\partial\mathbb{H}^n = \{(x_1, x_2, \dots, x_{n-1}, 0) \mid x_1, \dots, x_{n-1} \in \mathbb{R}\} \cup \{\infty\}.$$

Thus \mathbb{H}^n is an n -dimensional hyperbolic analogue of the upper half-plane \mathbb{H} and $\partial\mathbb{H}^n$ is an n -dimensional analogue of the boundary of \mathbb{H} .

We can again define distance in \mathbb{H}^n by first defining the length of a (piecewise continuously differentiable) path, and then defining the distance between two points as the

infimum of the length of all (piecewise continuously differentiable) paths between them. If $\sigma = (\sigma_1, \dots, \sigma_n) : [a, b] \rightarrow \mathbb{H}^n$ is a piecewise continuously differentiable path then we define

$$\text{length}_{\mathbb{H}^n}(\sigma) = \int_a^b \frac{\|\sigma'(t)\|}{\sigma_n(t)} dt$$

where $\|\sigma'(t)\| = \sqrt{\sigma_1'(t)^2 + \dots + \sigma_n'(t)^2}$. Then for $z, w \in \mathbb{H}^n$ define

$$d_{\mathbb{H}^n}(z, w) = \inf\{\text{length}_{\mathbb{H}^n}(\sigma) \mid \sigma \text{ is a piecewise continuously differentiable path from } z \text{ to } w\}.$$

We can then go on to study and classify the higher-dimensional Möbius transformations. We can study discrete subgroups of these groups, and formulate a version of Poincaré's Theorem. We could also go on to study higher dimensional hyperbolic 'surfaces' by taking \mathbb{H}^n and quotienting it by a discrete group. This gives us an extremely powerful method of constructing a very large class of geometric spaces with many interesting properties, many of which are still topics of current research.

29. All of the exercises

§29.1 Introduction

The exercises are scattered throughout the notes where they are relevant to the material being discussed. For convenience, all of the exercises are given below. The numbering convention is that Exercise $n.m$ is the m th exercise in lecture n . Thus, once we've done lecture n in class, you will be able to do all the exercises numbered $n.m$.

Particularly important exercises are labelled *. Particularly unimportant exercises, notably those that are there purely for completeness (such as proving that a given definition makes sense, or illustrating a minor point from the lectures) are labelled b . (Caveat: this is purely to help you focus your revision, do not read too much into the distinction between starred and unstarred exercises!)

Remember that:

- The 10-credit MATH32051 version of the course consists of lectures 1–22, 28.
- The 15-credit MATH42051/62051 version of the course consists of lectures 1–28.

§29.2 The exercises

Exercise 1.1b

Let R_θ denote the 2×2 matrix that rotates \mathbb{R}^2 clockwise about the origin through angle $\theta \in [0, 2\pi)$. Thus R_θ has matrix

$$\begin{pmatrix} \cos \theta & \sin \theta \\ -\sin \theta & \cos \theta \end{pmatrix}.$$

Let $a = (a_1, a_2) \in \mathbb{R}^2$. Define the transformation

$$T_{\theta,a} : \mathbb{R}^2 \rightarrow \mathbb{R}^2$$

by

$$T_{\theta,a} \begin{pmatrix} x \\ y \end{pmatrix} = \begin{pmatrix} \cos \theta & \sin \theta \\ -\sin \theta & \cos \theta \end{pmatrix} \begin{pmatrix} x \\ y \end{pmatrix} + \begin{pmatrix} a_1 \\ a_2 \end{pmatrix};$$

thus $T_{\theta,a}$ first rotates the point (x, y) about the origin through an angle θ and then translates by the vector a .

Let $G = \{T_{\theta,a} \mid \theta \in [0, 2\pi), a \in \mathbb{R}^2\}$.

- (i) Let $\theta, \phi \in [0, 2\pi)$ and let $a, b \in \mathbb{R}^2$. Find an expression for the composition $T_{\theta,a} \circ T_{\phi,b}$. Hence show that G is a group under composition of maps (i.e. show that this product is
- (a) well-defined (i.e. the composition of two elements of G gives another element of G),
 - (b) associative (hint: you already know that composition of functions is associative),
 - (c) that there is an identity element, and (d) that inverses exist).

- (ii) Show that the set of all rotations about the origin is a subgroup of G .
- (iii) Show that the set of all translations is a subgroup of G .

One can show that G is actually the group $\text{Isom}^+(\mathbb{R}^2)$ of orientation preserving isometries of \mathbb{R}^2 with the Euclidean matrices.

Exercise 2.1

Consider the two parametrisations

$$\begin{aligned}\sigma_1 : [0, 2] &\rightarrow \mathbb{H} & : & t \mapsto t + i, \\ \sigma_2 : [1, 2] &\rightarrow \mathbb{H} & : & t \mapsto (t^2 - t) + i.\end{aligned}$$

Verify that these two parametrisations define the same path σ .

Let $f(z) = 1/\text{Im}(z)$. Calculate $\int_{\sigma} f$ using both of these parametrisations.

The point of this exercise is to show that we can often simplify calculating the integral $\int_{\sigma} f$ of a function f along a path σ by choosing a good parametrisation.

Exercise 2.2

Consider the points i and ai where $0 < a < 1$.

- (i) Consider the path σ between i and ai that consists of the arc of imaginary axis between them. Find a parametrisation of this path.
- (ii) Show that

$$\text{length}_{\mathbb{H}}(\sigma) = \log 1/a.$$

(Notice that as $a \rightarrow 0$, we have that $\log 1/a \rightarrow \infty$. This motivates why we call $\mathbb{R} \cup \{\infty\}$ the circle at *infinity*.)

Exercise 2.3*

Show that $d_{\mathbb{H}}$ satisfies the *triangle inequality*:

$$d_{\mathbb{H}}(x, z) \leq d_{\mathbb{H}}(x, y) + d_{\mathbb{H}}(y, z), \quad \forall x, y, z \in \mathbb{H}.$$

That is, the distance between two points is increased if one goes via a third point.

Exercise 3.1*

Let L be a straight line in \mathbb{C} with equation (3.3.2). Calculate its gradient and intersections with the real and imaginary axes in terms of α, β, γ .

Exercise 3.2*

Let C be a circle in \mathbb{C} with equation (3.3.2). Calculate the centre and radius of C in terms of α, β, γ .

Exercise 3.3*

Let γ be a Möbius transformation of \mathbb{H} . Show that γ maps \mathbb{H} to itself bijectively and give an explicit expression for the inverse map.

Exercise 3.4*

Prove Proposition 3.5.1 [that the set of Möbius transformations of \mathbb{H} form a group under composition]. (To do this, you must: (i) show that the composition $\gamma_1\gamma_2$ of two Möbius transformations of \mathbb{H} is a Möbius transformation of \mathbb{H} , (ii) check associativity (hint: you

already know that composition of maps is associative), (iii) show that the identity map $z \mapsto z$ is a Möbius transformation, and (iv) show that if $\gamma \in \text{Möb}(\mathbb{H})$ is a Möbius transformation of \mathbb{H} , then γ^{-1} exists and is a Möbius transformation of \mathbb{H} .)

Exercise 3.5b

Show that dilations, translations and the inversion $z \mapsto -1/z$ are indeed Möbius transformations of \mathbb{H} by writing them in the form $z \mapsto (az + b)/(cz + d)$ for suitable $a, b, c, d \in \mathbb{R}$, $ad - bc > 0$.

Exercise 4.1b

Show that if $ad - bc \neq 0$ then γ maps $\partial\mathbb{H}$ to itself bijectively.

Exercise 4.2*

Prove the two facts used in the above proof [of Proposition 4.1.1]:

$$\begin{aligned} |\gamma'(z)| &= \frac{ad - bc}{|cz + d|^2}, \\ \text{Im}(\gamma(z)) &= \frac{(ad - bc)}{|cz + d|^2} \text{Im}(z). \end{aligned}$$

Exercise 4.3b

Let $z = x + iy \in \mathbb{H}$ and define $\gamma(z) = -x + iy$. (Note that γ is *not* a Möbius transformation of \mathbb{H} .)

- (i) Show that γ maps \mathbb{H} to \mathbb{H} bijectively.
- (ii) Let $\sigma : [a, b] \rightarrow \mathbb{H}$ be a differentiable path. Show that

$$\text{length}_{\mathbb{H}}(\gamma \circ \sigma) = \text{length}_{\mathbb{H}}(\sigma).$$

Hence conclude that γ is an isometry of \mathbb{H} .

Exercise 4.4

Let $H_1, H_2 \in \mathcal{H}$. Show that there exists a Möbius transformation γ of \mathbb{H} that maps H_1 to H_2 .

Exercise 5.1

Let $H_1, H_2 \in \mathcal{H}$ and let $z_1 \in H_1, z_2 \in H_2$. Show that there exists a Möbius transformation γ of \mathbb{H} such that $\gamma(H_1) = H_2$ and $\gamma(z_1) = z_2$. In particular, conclude that given $z_1, z_2 \in \mathbb{H}$, one can find a Möbius transformation γ of \mathbb{H} such that $\gamma(z_1) = z_2$.

(Hint: you know that there exists $\gamma_1 \in \text{Möb}(\mathbb{H})$ that maps H_1 to the imaginary axis and z_1 to i ; similarly you know that there exists $\gamma_2 \in \text{Möb}(\mathbb{H})$ that maps H_2 to the imaginary axis and z_2 to i . What does γ_2^{-1} do?)

Exercise 5.2*

For each of the following pairs of points, describe (either by giving an equation in the form $\alpha z \bar{z} + \beta z \beta \bar{z} + \gamma$, or in words) the geodesic between them:

- (i) $-3 + 4i, -3 + 5i$,
- (ii) $-3 + 4i, 3 + 4i$,

(iii) $-3 + 4i, 5 + 12i$.

Exercise 5.3

Prove Proposition 5.5.2 using the following steps. For $z, w \in \mathbb{H}$ let

$$\begin{aligned} \text{LHS}(z, w) &= \cosh d_{\mathbb{H}}(z, w) \\ \text{RHS}(z, w) &= 1 + \frac{|z - w|^2}{2 \operatorname{Im}(z) \operatorname{Im}(w)} \end{aligned}$$

denote the left- and right-hand sides of (5.5.1) [the formula for $\cosh d_{\mathbb{H}}(z, w)$] respectively. We want to show that $\text{LHS}(z, w) = \text{RHS}(z, w)$ for all $z, w \in \mathbb{H}$.

(i) Let $\gamma \in \text{Möb}(\mathbb{H})$ be a Möbius transformation of \mathbb{H} . Using the fact that γ is an isometry, prove that

$$\text{LHS}(\gamma(z), \gamma(w)) = \text{LHS}(z, w).$$

Using Exercise 4.2 and Lemma 5.5.1, prove that

$$\text{RHS}(\gamma(z), \gamma(w)) = \text{RHS}(z, w).$$

(ii) Let H denote the geodesic passing through z, w . By Lemma 4.3.1 there exists a Möbius transformation γ of \mathbb{H} that maps H to the imaginary axis. Let $\gamma(z) = ia$ and $\gamma(w) = ib$. Prove, using the fact that $d_{\mathbb{H}}(ia, ib) = \log b/a$ if $a < b$, that for this choice of γ we have

$$\text{LHS}(\gamma(z), \gamma(w)) = \text{RHS}(\gamma(z), \gamma(w)).$$

(iii) Conclude that $\text{LHS}(z, w) = \text{RHS}(z, w)$ for all $z, w \in \mathbb{H}$.

Exercise 5.4

A hyperbolic circle C with centre $z_0 \in \mathbb{H}$ and radius $r > 0$ is defined to be the set of all points of hyperbolic distance r from z_0 . Using equation (5.5.1) [the formula for $\cosh d_{\mathbb{H}}(z, w)$], show that a hyperbolic circle is a Euclidean circle (i.e. an ordinary circle) but with a different centre and radius.

Exercise 5.5*

Recall that we defined the hyperbolic distance by first defining the hyperbolic length of a piecewise continuously differentiable path σ :

$$\text{length}_{\mathbb{H}}(\sigma) = \int \frac{|\sigma'(t)|}{\operatorname{Im}(\sigma(t))} dt = \int_{\sigma} \frac{1}{\operatorname{Im}(z)}. \quad (29.2.1)$$

We then saw that the Möbius transformations of \mathbb{H} are isometries.

Why did we choose the function $1/\operatorname{Im} z$ in (29.2.1)? In fact, one can choose *any* positive function and use it to define the length of a path, and hence the distance between two points. However, the geometry that one gets may be very complicated (for example, there may be many geodesics between two points); alternatively, the geometry may not be very interesting (for example, there may be very few symmetries, i.e. the group of isometries is very small).

The group of Möbius transformations of \mathbb{H} is, as we shall see, a very rich group with lots of interesting structure. The point of this exercise is to show that if we want the Möbius transformations of \mathbb{H} to be isometries then we must define hyperbolic length by (29.2.1).

Let $\rho : \mathbb{H} \rightarrow \mathbb{R}$ be a continuous positive function. Define the ρ -length of a path $\sigma : [a, b] \rightarrow \mathbb{H}$ to be

$$\text{length}_\rho(\sigma) = \int_\sigma \rho = \int_a^b \rho(\sigma(t)) |\sigma'(t)| dt.$$

- (i) Suppose that length_ρ is invariant under Möbius transformations of \mathbb{H} , i.e. if $\gamma \in \text{Möb}(\mathbb{H})$ then $\text{length}_\rho(\gamma \circ \sigma) = \text{length}_\rho(\sigma)$. Prove that

$$\rho(\gamma(z)) |\gamma'(z)| = \rho(z). \quad (29.2.2)$$

(Hint: you may use the fact that if f is a continuous function such that $\int_\sigma f = 0$ for every path σ then $f = 0$.)

- (ii) By taking $\gamma(z) = z + b$ in (29.2.2), deduce that $\rho(z)$ depends only on the imaginary part of z . Hence we may write ρ as $\rho(y)$ where $z = x + iy$.
- (iii) By taking $\gamma(z) = kz$ in (29.2.2), deduce that $\rho(y) = c/y$ for some constant $c > 0$.

Hence, up to a normalising constant c , we see that if we require the Möbius transformations of \mathbb{H} to be isometries, then the distance in \mathbb{H} must be given by the formula we introduced in Lecture 2.

Exercise 5.6*

- (i) Let C_1 and C_2 be two circles in \mathbb{R}^2 with centres c_1, c_2 and radii r_1, r_2 , respectively. Suppose C_1 and C_2 intersect. Let θ denote the internal angle at the point of intersection (see Figure 5.6). Show that

$$\cos \theta = \frac{|c_1 - c_2|^2 - (r_1^2 + r_2^2)}{2r_1r_2}.$$

- (ii) Consider the geodesic between -6 and 6 and the geodesic between $4\sqrt{2}$ and $6\sqrt{2}$, as illustrated in Figure 5.6). Both of these geodesics are semi-circles. Find the centre and radius of each semi-circle. Hence use the result in (i) to calculate the angle ϕ .

Exercise 5.7*

Suppose that two geodesics intersect as illustrated in Figure 5.6.5. Show that

$$\sin \theta = \frac{2ab}{a^2 + b^2}, \quad \cos \theta = \frac{b^2 - a^2}{a^2 + b^2}.$$

Exercise 6.1b

Check some of the assertions above, for example:

- (i) Show that h maps \mathbb{H} to \mathbb{D} bijectively. Show that h maps $\partial\mathbb{H}$ to $\partial\mathbb{D}$ bijectively.
- (ii) Calculate $g(z) = h^{-1}(z)$ and show that

$$g'(z) = \frac{-2}{(-iz + 1)^2}, \quad \text{Im}(g(z)) = \frac{1 - |z|^2}{|-iz + 1|^2}.$$

- (iii) Mimic the proof of Proposition 4.2.1 to show that the real axis is the unique geodesic joining 0 to $x \in (0, 1)$ and that

$$d_{\mathbb{D}}(0, x) = \log \left(\frac{1+x}{1-x} \right).$$

Exercise 6.2

Show that $z \mapsto h\gamma h^{-1}(z)$ is a map of the form

$$z \mapsto \frac{\alpha z + \beta}{\beta z + \bar{\alpha}}, \quad \alpha, \beta \in \mathbb{C}, \quad |\alpha|^2 - |\beta|^2 > 0.$$

Exercise 6.3

Check directly that $\text{Möb}(\mathbb{D})$ is a group under composition.

Exercise 6.4

Show that the geodesics in \mathbb{D} have equations of the form

$$\alpha z \bar{z} + \beta z + \bar{\beta} \bar{z} + \alpha = 0$$

where $\alpha \in \mathbb{R}$ and $\beta \in \mathbb{C}$.

Exercise 6.5*

Let $C = \{w \in \mathbb{D} \mid d_{\mathbb{D}}(z_0, w) = r\}$ be a hyperbolic circle in \mathbb{D} with centre z_0 and radius $r > 0$. Calculate the circumference and area of C .

[Hints: First move C to the origin by using a Möbius transformation of \mathbb{D} . Use the formula $d_{\mathbb{D}}(0, x) = \log(1+x)/(1-x)$ to show that this is a Euclidean circle, but with a different radius. To calculate area, use polar co-ordinates.]

Exercise 7.1

Consider the hyperbolic triangle in \mathbb{H} with vertices at 0, $(-1 + i\sqrt{3})/2$, $(1 + i\sqrt{3})/2$ as illustrated in Figure 7.2.5.

- (i) Determine the geodesics that comprise the sides of this triangle.
- (ii) Use Exercise 5.6 to calculate the internal angles of this triangle. Hence use the Gauss-Bonnet Theorem to calculate the hyperbolic area of this triangle.

Exercise 7.2*

Assuming Theorem 7.2.1 but not Theorem 7.2.2, prove that the area of a hyperbolic quadrilateral with internal angles $\alpha_1, \alpha_2, \alpha_3, \alpha_4$ is given by

$$2\pi - (\alpha_1 + \alpha_2 + \alpha_3 + \alpha_4).$$

Exercise 7.3*

Let $n \geq 3$. By explicit construction, show that there exists a regular n -gon with internal angle equal to α if and only if $\alpha \in [0, (n-2)\pi/n)$.

(Hint: Work in the Poincaré disc \mathbb{D} . Let $\omega = e^{2\pi i/n}$ be an n^{th} root of unity. Fix $r \in (0, 1)$ and consider the polygon $D(r)$ with vertices at $r, r\omega, r\omega^2, \dots, r\omega^{n-1}$. This is a regular n -gon (why?). Let $\alpha(r)$ denote the internal angle of $D(r)$. Use the Gauss-Bonnet

Theorem to express the area of $D(r)$ in terms of $\alpha(r)$. Examine what happens as $r \rightarrow 0$ and as $r \rightarrow 1$. (To examine $\lim_{r \rightarrow 0} \text{Area}_{\mathbb{H}} D(r)$, note that $D(r)$ is contained in a hyperbolic circle $C(r)$, and use Exercise 6.5 to calculate $\lim_{r \rightarrow 0} \text{Area}_{\mathbb{H}} C(r)$.) You may use without proof the fact that $\alpha(r)$ depends continuously on r .)

In particular, conclude that there exists a regular n -gon with each internal angle equal to a right-angle whenever $n \geq 5$. This is in contrast with the Euclidean case where, of course, the only regular polygon with each internal angle equal to a right-angle is the square.

Exercise 7.4b

(This exercise is outside the scope of the course (and therefore not examinable!). However, anybody remotely interested in pure mathematics should get to see what is below at least once!)

A *polyhedron* in \mathbb{R}^3 is formed by joining together polygons along their edges. A *platonic solid* is a convex polyhedra where each constituent polygon is a regular n -gon, with k polygons meeting at each vertex.

By mimicking the discussions above, show that there are precisely five platonic solids: the tetrahedron, cube, octahedron, dodecahedron and icosahedron (corresponding to $(n, k) = (3, 3), (4, 3), (3, 4), (5, 3)$ and $(3, 5)$, respectively).

Exercise 8.1

Assuming that $\tan \alpha = \tanh a / \sinh b$, prove that $\sin \alpha = \sinh a / \sinh c$ and $\cos \alpha = \tanh b / \tanh c$.

Exercise 8.2

We now have relationships involving: (i) three angles (the Gauss-Bonnet Theorem), (ii) three sides (Pythagoras' Theorem) and (iii) two sides, one angle. Prove the following relationships between one side and two angles:

$$\cosh a = \cos \alpha \operatorname{cosec} \beta, \quad \cosh c = \cot \alpha \cot \beta.$$

What are the Euclidean analogues of these identities?

Exercise 8.3

Assuming that $\sin \alpha = 1 / \cosh a$, check using standard trig and hyperbolic trig identities that $\cos \alpha = 1 / \coth a$ and $\tan \alpha = 1 / \sinh a$.

Exercise 8.4

Prove Proposition 8.4.1 in the case when Δ is acute (the obtuse case is a simple modification of the argument, and is left for anybody interested...).

(Hint: label the vertices A, B, C with angle α at vertex A , etc. Drop a perpendicular from vertex B meeting the side $[A, C]$ at, say, D to obtain two right-angled triangles ABD , BCD . Use Pythagoras' Theorem and Proposition 8.2.1 in both of these triangles to obtain an expression for $\sin \alpha$.)

Exercise 9.1*

Find the fixed points in $\mathbb{H} \cup \partial\mathbb{H}$ of the following Möbius transformations of \mathbb{H} :

$$\gamma_1(z) = \frac{2z + 5}{-3z - 1}, \quad \gamma_2(z) = 7z + 6, \quad \gamma_3(z) = -\frac{1}{z}, \quad \gamma_4(z) = \frac{z}{z + 1}.$$

In each case, state whether the map is parabolic, elliptic or hyperbolic.

Exercise 9.2

Normalise the Möbius transformations of \mathbb{H} given in Exercise 9.1.

Exercise 9.3b

- (i) Show that $\text{SL}(2, \mathbb{R})$ is indeed a group (under matrix multiplication). (Recall that G is a group if: (i) if $g, h \in G$ then $gh \in G$, (ii) the identity is in G , (iii) if $g \in G$ then there exists $g^{-1} \in G$ such that $gg^{-1} = g^{-1}g = \text{identity}$.)
- (ii) Define the subgroup

$$\text{SL}(2, \mathbb{Z}) = \left\{ \begin{pmatrix} a & b \\ c & d \end{pmatrix} \mid a, b, c, d \in \mathbb{Z}; ad - bc = 1 \right\}$$

to be the subset of $\text{SL}(2, \mathbb{R})$ where all the entries are integers. Show that $\text{SL}(2, \mathbb{Z})$ is a subgroup of $\text{SL}(2, \mathbb{R})$. (Recall that if G is a group and $H \subset G$ then H is a subgroup if it is itself a group.)

Exercise 10.1

- (i) Prove that conjugacy between Möbius transformations of \mathbb{H} is an equivalence relation.
- (ii) Show that if γ_1 and γ_2 are conjugate then they have the same number of fixed points. Hence show that if γ_1 is hyperbolic, parabolic or elliptic then γ_2 is hyperbolic, parabolic or elliptic, respectively.

Exercise 10.2

Prove Proposition 10.2.1. (Hint: show that if $A_1, A_2, A \in \text{SL}(2, \mathbb{R})$ are matrices such that $A_1 = A^{-1}A_2A$ then $\text{Trace}(A_1) = \text{Trace}(A^{-1}A_2A) = \text{Trace}(A_2)$. You might first want to show that $\text{Trace}(AB) = \text{Trace}(BA)$ for any two matrices A, B .)

Exercise 10.3

Let $\gamma(z) = z + b$. If $b > 0$ then show that γ is conjugate to $\gamma(z) = z + 1$. If $b < 0$ then show that γ is conjugate to $\gamma(z) = z - 1$. Are $z \mapsto z - 1, z \mapsto z + 1$ conjugate?

Exercise 11.1

Show that two dilations $z \mapsto k_1z, z \mapsto k_2z$ are conjugate (as Möbius transformations of \mathbb{H}) if and only if $k_1 = k_2$ or $k_1 = 1/k_2$.

Exercise 11.2

Let $\gamma \in \text{Möb}(\mathbb{H})$ be a hyperbolic Möbius transformation of \mathbb{H} . By the above result, we know that γ is conjugate to a dilation $z \mapsto kz$. Find a relationship between $\tau(\gamma)$ and k .

Exercise 11.3

Let $\gamma \in \text{Möb}(\mathbb{D})$ be an elliptic Möbius transformation of \mathbb{D} . By the above result, we know that γ is conjugate to a rotation $z \mapsto e^{i\theta}z$. Find a relationship between $\tau(\gamma)$ and θ .

Exercise 12.1

Show that for each $q \in \mathbb{N}$, Γ_q , as defined above, is indeed a subgroup of $\text{Möb}(\mathbb{H})$.

Exercise 12.2*

Fix $k > 0, k \neq 1$. Consider the subgroup of $\text{Möb}(\mathbb{H})$ generated by the Möbius transformations of \mathbb{H} given by

$$\gamma_1(z) = z + 1, \quad \gamma_2(z) = kz.$$

Is this a Fuchsian group? (Hint: consider $\gamma_2^{-n}\gamma_1^m\gamma_2^n(z)$.)

Exercise 13.1*

Figures 13.2.1 and 13.2.2 illustrate two tessellations of \mathbb{H} . What do these tessellations look like in the Poincaré disc \mathbb{D} ?

Exercise 14.1b

(Included for completeness only.) Show that a convex hyperbolic polygon is an open subset of \mathbb{H} . To do this, first show that a half-plane is an open set. Then show that the intersection of a finite number of open sets is open.

Exercise 14.2

- (i) Write $z_1 = x_1 + iy_1$, $z_2 = x_2 + iy_2$, $z_1, z_2 \in \mathbb{H}$. Show that the perpendicular bisector of $[z_1, z_2]$ can also be written as

$$\{z \in \mathbb{H} \mid y_2|z - z_1|^2 = y_1|z - z_2|^2\}.$$

- (ii) Hence describe the perpendicular bisector of the arc of geodesic between $1 + 2i$ and $(6 + 8i)/5$.

Exercise 15.1*

Let $\Gamma = \{\gamma_n \mid \gamma_n(z) = 2^n z, n \in \mathbb{Z}\}$. This is a Fuchsian group. Choose a suitable $p \in \mathbb{H}$ and construct a Dirichlet polygon $D(p)$.

Exercise 16.1

Take $\Gamma = \{\gamma_n \mid \gamma_n(z) = 2^n z, n \in \mathbb{Z}\}$. Calculate the side-pairing transformations for the Dirichlet polygon calculated in Exercise 15.1.

Exercise 17.1b

Convince yourself that the above two claims [defining elliptic cycles] are true.

Exercise 17.2b

- (i) Show that $\gamma_{v_0, s_0}, \gamma_{v_i, s_i}$ have the same order.
- (ii) Show that if γ has order m then so does γ^{-1} .

Exercise 18.1

Check the assertion in example (v) above, i.e. show that if $\Gamma = \langle a, b \mid a^4 = b^2 = (ab)^2 = e \rangle$ then Γ contains exactly 8 elements.

Exercise 19.1b

Take a hyperbolic quadrilateral such that each pair of opposing sides have the same length. Define two side-pairing transformation γ_1, γ_2 that pair each pair of opposite sides. See Figure 29.2.1. Show that there is only one elliptic cycle and determine the associated elliptic cycle transformation. When do γ_1 and γ_2 generate a Fuchsian group?

Exercise 20.1*

Consider the polygon in Figure 29.2.2. The side-pairing transformations are:

$$\gamma_1(z) = z + 2, \quad \gamma_2(z) = \frac{z}{2z + 1}.$$

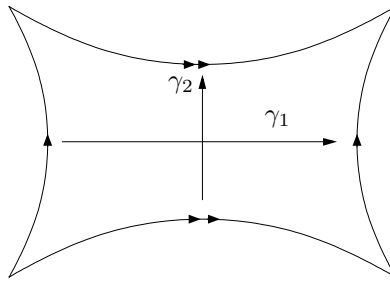

Figure 29.2.1: A hyperbolic quadrilateral with opposite sides paired

What are the elliptic cycles? What are the parabolic cycles? Use Poincaré’s Theorem to show that the Fuchsian group generated by γ_1, γ_2 is discrete and has the polygon in Figure 29.2.2 as a fundamental domain. Use Poincaré’s Theorem to show that the group generated by γ_1, γ_2 is the free group on 2 generators.

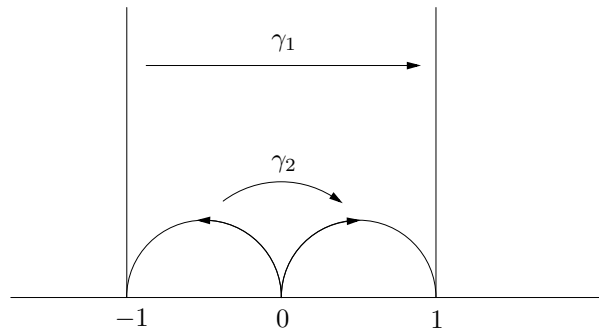

Figure 29.2.2: A fundamental domain for the free group on 2 generators

Exercise 20.2*

Consider the hyperbolic quadrilateral with vertices

$$A = -\left(1 + \frac{\sqrt{2}}{2}\right), B = i\frac{\sqrt{2}}{2}, C = \left(1 + \frac{\sqrt{2}}{2}\right), \text{ and } \infty$$

and a right-angle at B , as illustrated in Figure 29.2.3.

- (i) Verify that the following Möbius transformations are side-pairing transformations:

$$\gamma_1(z) = z + 2 + \sqrt{2}, \quad \gamma_2(z) = \frac{\frac{\sqrt{2}}{2}z - \frac{1}{2}}{z + \frac{\sqrt{2}}{2}}.$$

- (ii) By using Poincaré’s Theorem, show that these side-pairing transformations generate a Fuchsian group. Give a presentation of Γ in terms of generators and relations.

Exercise 21.1*

Consider the hyperbolic polygon illustrated in Figure 29.2.4 with the side-pairing transformations as indicated (note that one side is paired with itself). Assume that $\theta_1 + \theta_2 + \theta_3 = 2\pi$ (one can show that such a polygon exists).

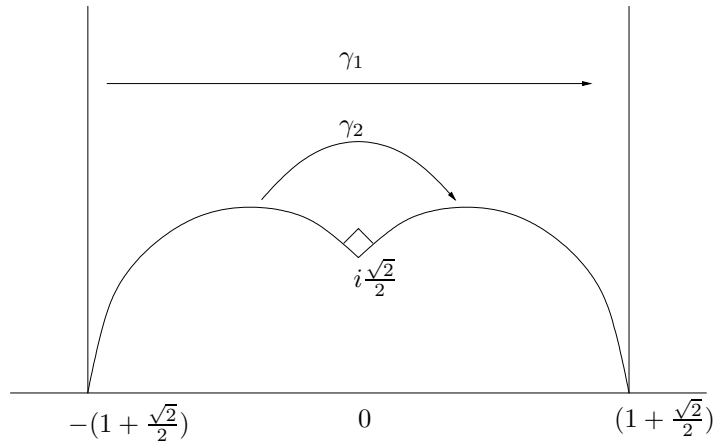

Figure 29.2.3: A hyperbolic quadrilateral

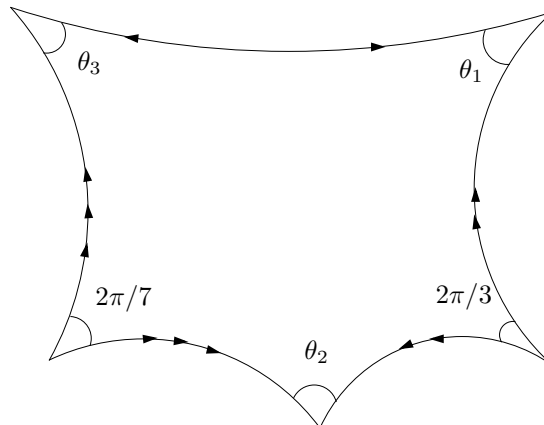

Figure 29.2.4: A hyperbolic polygon with sides paired as indicated

- (i) Show that there are 3 non-accidental cycles and 1 accidental cycle.
- (ii) Show that the side-pairing transformations generate a Fuchsian group Γ and give a presentation of Γ in terms of generators and relations.
- (iii) Calculate the signature of Γ .

Exercise 21.2*

Consider the regular hyperbolic octagon with each internal angle equal to θ and the sides paired as indicated in Figure 29.2.5. Use Exercise 7.3 to show that such an octagon exists provided $\theta \in [0, 3\pi/4)$.

For which values of θ do $\gamma_1, \gamma_2, \gamma_3, \gamma_4$ generate a Fuchsian group Γ_θ ? In each case when Γ_θ is a Fuchsian group write down a presentation of Γ_θ , determine the signature $\text{sig}(\Gamma_\theta)$ and briefly describe geometrically the quotient space \mathbb{H}/Γ_θ .

Exercise 21.3

This exercise works through the above [in Lecture 21] calculations in the case when we allow parabolic cycles.

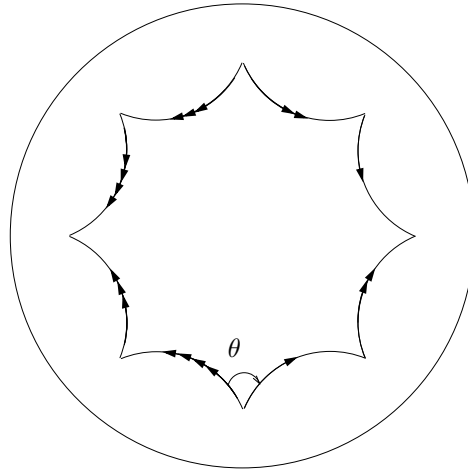

Figure 29.2.5: See Exercise 21.2

Let Γ be a Fuchsian group and let D be a Dirichlet polygon for D . We allow D to have vertices on $\partial\mathbb{H}$, but we assume that D has no free edges (so that no arcs of $\partial\mathbb{H}$ are edges). We also assume that no side of D is paired with itself.

The space \mathbb{H}/Γ then has a genus (heuristically, the number of handles), possibly some marked points, and cusps. The cusps arise from gluing together the vertices on parabolic cycles and identifying the sides on each parabolic cycle.

- (i) Convince yourself that the $\mathbb{H}/\mathrm{PSL}(2, \mathbb{Z})$ has genus 0, one marked point of order 3, one marked point of order 2, and one cusp.

(Hint: remember that a side is not allowed to be paired to itself.)

Suppose that \mathbb{H}/Γ has genus g , r marked points of order m_1, \dots, m_r , and c cusps. We define the signature of Γ to be

$$\mathrm{sig}(\Gamma) = (g; m_1, \dots, m_r; c).$$

- (ii) Using the Gauss-Bonnet Theorem, show that

$$\mathrm{Area}_{\mathbb{H}}(D) = 2\pi \left((2g - 2) + \sum_{j=1}^r \left(1 - \frac{1}{m_j} \right) + c \right).$$

- (iii) Show that if $c \geq 1$ then

$$\mathrm{Area}_{\mathbb{H}}(D) \geq \frac{\pi}{3}$$

and that this lower bound is achieved for just one Fuchsian group (which one?).

Exercise 23.1b

Let (X, d) be a metric space. Let $K \subset X$ be a compact subset and let $F \subset K$ be a closed subset of K . By using Proposition 23.2.2 show that F is itself compact.

Exercise 23.2

Prove that an isometry is continuous.

Exercise 23.3

Let (X, d) be a metric space and let $Y \subset X$. Show that the following are equivalent:

- (i) Y is a discrete subset;
- (ii) if $x_n \in Y$ is a sequence in Y such that $x_n \rightarrow x \in Y$ as $n \rightarrow \infty$, then there exists $N \in \mathbb{N}$ such that $x_n = x$ for all $n \geq N$.

Exercise 23.4*

Show that, for each $x \in X$, $\text{Stab}_\Gamma(x)$ is a subgroup of Γ .

Exercise 23.5*

Let $X = \mathbb{H}$ with the hyperbolic metric $d_{\mathbb{H}}$. Let $\Gamma = \text{Möb}(\mathbb{H})$ be the group of all Möbius transformations of \mathbb{H} . Calculate the orbit of i and the stabiliser of i .

Exercise 23.6*

Calculate $\text{Stab}_{\text{PSL}(2, \mathbb{Z})}(i)$.

Exercise 23.7*

Recall that the modular group $\Gamma = \text{PSL}(2, \mathbb{Z})$ acts by homeomorphisms on $\partial\mathbb{H}$. Show that Γ does not act properly discontinuously in three ways: (i) by showing that it does not satisfy the definition of a properly discontinuous group actions, (ii) by finding a point x such that $\Gamma(x)$ is not discrete, (iii) by finding a point x such that $\text{Stab}_\Gamma(x)$ is infinite.

Exercise 23.8*

Naively, one might expect the intersection between a compact set and a discrete set to be finite. This is not the case, and it is easy to find counterexamples. (Can you think of one?)

- (i) Give an example of a metric space X , a group Γ of homeomorphisms acting on X , a point $x \in X$ and a compact set K such that $\Gamma(x)$ is discrete but $K \cap \Gamma(x)$ is infinite.
- (ii) Suppose that Γ is now a group of isometries.
Suppose that the orbit $\Gamma(x)$ of x is discrete. Show that one can find $\varepsilon > 0$ such that $B_\varepsilon(\gamma(x)) \cap \Gamma(x) = \{\gamma(x)\}$ for all $\gamma \in \Gamma$. (That is, the ε in the definition of discreteness can be chosen to be independent of the point in the orbit.)
- (ii) Conclude that if Γ acts by isometries, $\Gamma(x)$ is discrete and K is compact then $K \cap \Gamma(x)$ is finite.

Exercise 24.1

Give an example of a metric space (X, d) and a group Γ of isometries that acts properly discontinuously on X for which the conclusion of Proposition 24.2.3 fails, i.e. there exists a point $p \in X$ which is fixed by some non-trivial element of Γ and for which there are points arbitrarily close (but not equal) to p that are also fixed under some non-trivial elements of Γ . (Hint: where did we use the fact that we are working with Möbius transformations in the above proof?)

Exercise 24.2*

In the upper half-plane, take $\Gamma = \{\gamma_n \mid \gamma_n(z) = z + n, n \in \mathbb{Z}\}$. Find $\Lambda(\Gamma)$.

Exercise 24.3*

Prove Proposition 24.4.2: namely, show that if $\zeta_n \in \Lambda(\Gamma)$ and $\zeta_n \rightarrow \zeta \in \partial\mathbb{D}$ then $\zeta \in \Lambda(\Gamma)$.

Exercise 24.4

Prove Proposition 24.4.5(ii).

Exercise 24.5*

Let $p, q \in \mathbb{Z}$, $q \neq 0$. Consider the Möbius transformation of \mathbb{H} given by

$$\gamma(z) = \frac{(1 + pq)z - p^2}{q^2z + (1 - pq)}.$$

Show that $\gamma \in \text{PSL}(2, \mathbb{Z})$. By considering the fixed point(s) of γ , show that $\Lambda(\text{PSL}(2, \mathbb{Z})) = \partial\mathbb{H}$.

Exercise 24.6

Check that all three possibilities [of cardinalities of limit sets] can occur: namely, write down examples of Fuchsian groups $\Gamma_0, \Gamma_1, \Gamma_2, \Gamma_\infty$ such that $\Lambda(\Gamma_j)$ has, respectively, 0, 1, 2, ∞ elements. (In a later section we shall classify all Fuchsian groups for which $\Lambda(\Gamma)$ is finite.)

Exercise 25.1

Show that any cyclic group is abelian.

Exercise 25.2

Prove Lemma 25.1.1. (Hint: Suppose that $\Gamma < \mathbb{R}$ is a discrete subgroup. Choose an element $0 < y \in \Gamma$ such that no other element of Γ lies between 0 and y (why does such an element exist?). Show that y generates Γ .)

Exercise 25.3b

Prove Lemma 25.2.1.

Exercise 25.4b

- (i) Consider the hyperbolic transformation $\gamma(z) = kz$. Show that $C_{\text{Möb}(\mathbb{H})}(\gamma)$ is the set of all dilations $\{\gamma(z) = \lambda z \mid \lambda > 0\}$.
- (ii) Consider the elliptic transformation $\gamma(z) = e^{i\theta}z$ of \mathbb{D} . Show that $C_{\text{Möb}(\mathbb{D})}(\gamma)$ is the set of all rotations around $0 \in \mathbb{D}$.

Exercise 25.5b

Let Γ be a group and let $H < \Gamma$ be a subgroup. We define

$$N_\Gamma(H) = \{\gamma \in \Gamma \mid \gamma H \gamma^{-1} = H\}$$

to be the *normaliser* of H in Γ . That is, the normaliser of H is the largest subgroup of Γ in which H is a normal subgroup.

- (i) Check that $N_\Gamma(H)$ is a subgroup of Γ .
- (ii) Let $\Gamma < \text{Möb}(\mathbb{H})$ be a non-abelian Fuchsian group. Prove that $N_{\text{Möb}(\mathbb{H})}(\Gamma)$ is also a Fuchsian group.
(Hint: Suppose not. Consider a sequence of elements of $N_{\text{Möb}(\mathbb{H})}(\Gamma)$ that converges to the identity.)

Exercise 26.1

Prove the converse to Proposition 26.2.1 [in the limit sets notes], namely that if Γ is an infinite cyclic group generated by a parabolic element then $\Lambda(\Gamma)$ has one element.

Exercise 26.2

Suppose that Γ is a non-elementary Fuchsian group. Prove that Γ must contain a hyperbolic element.

(Hints: First argue that, apart from the identity, either Γ contains only hyperbolic elements (in which case the statement follows trivially) or that it contains a parabolic element. By replacing Γ by a conjugate subgroup, we can assume that a parabolic element γ_1 has ∞ as a fixed point and so has the form $z \mapsto z + b$. If γ_2 is another element of Γ , consider $\tau(\gamma_2\gamma_1^n)$ for large n .)

30. Solutions

Solution 1.1

We write $T_{\theta,a}(x,y)$ in the form $R_{\theta}(x,y) + (a_1, a_2)$ where R_{θ} denotes the 2×2 matrix that rotates the plane about the origin by angle θ .

- (i) (a) Let $T_{\theta,a}, T_{\theta',a'} \in G$. We have to show that the composition $T_{\theta,a}T_{\theta',a'} \in G$. Now

$$\begin{aligned} T_{\theta,a}T_{\theta',a'}(x,y) &= T_{\theta,a}(T_{\theta',a'}(x,y)) \\ &= T_{\theta,a}(R_{\theta'}(x,y) + (a'_1, a'_2)) \\ &= R_{\theta}(R_{\theta'}(x,y) + (a'_1, a'_2)) + (a_1, a_2) \\ &= R_{\theta}R_{\theta'}(x,y) + (R_{\theta}(a'_1, a'_2) + (a_1, a_2)) \\ &= T_{\theta+\theta', R_{\theta}(a'_1, a'_2) + (a_1, a_2)}(x,y) \end{aligned}$$

where we have used the observation that $R_{\theta}R_{\theta'} = R_{\theta+\theta'}$. As $T_{\theta+\theta', R_{\theta}(a'_1, a'_2) + (a_1, a_2)} \in G$, the composition of two elements of G is another element of G , hence the group operation is well-defined.

- (b) This is trivial: composition of functions is already known to be associative.
 (c) The identity map on \mathbb{R}^2 is the map that leaves every point alone. We choose $\theta = 0$ and $a = (0, 0)$.

$$T_{0,(0,0)}(x,y) = R_0(x,y) + (0,0).$$

As R_0 is the rotation through angle 0, it is clearly the identity matrix, so that $R_0(x,y) = (x,y)$. Hence $T_{0,(0,0)}(x,y) = (x,y)$. Hence G has an identity element.

- (d) Let $T_{\theta,a} \in G$. We want to find an inverse for $T_{\theta,a}$ and show that it lies in G . Write

$$T_{\theta,a}(x,y) = (u,v).$$

Then

$$(u,v) = R_{\theta}(x,y) + (a_1, a_2)$$

and some re-arrangement, together with the fact that $R_{\theta}^{-1} = R_{-\theta}$, shows that

$$(x,y) = R_{-\theta}(u,v) - R_{-\theta}(a_1, a_2).$$

Hence $T_{\theta,a}^{-1} = T_{-\theta, -R_{-\theta}(a_1, a_2)}$, which is an element of G .

- (ii) The rotations about the origin have the form $T_{\theta,0}$. It is easy to check that $T_{\theta,0}T_{\theta',0} = T_{\theta+\theta',0}$ so that the composition of two rotations is another rotation. The identity map is a rotation (through angle 0). The inverse of rotation by θ is rotation by $-\theta$. Hence the set of rotations is a subgroup of G .

- (iii) The translations have the form $T_{0,a}$ where $a \in \mathbb{R}^2$. It is easy to see that $T_{0,a}T_{0,a'} = T_{0,a+a'}$ so that the composition of two translations is another translation. The identity map is a translation (by $(0,0)$). The inverse of translation by (a_1, a_2) is translation by $(-a_1, -a_2)$. Hence the set of translations is a subgroup of G .

Solution 2.1

- (i) The path determined by both σ_1 and σ_2 is a horizontal line from i to $2 + i$.
- (ii) We first calculate $\int_{\sigma} f$ along the path σ using the parametrisation σ_1 . Note that $\sigma_1'(t) = 1$ and $\text{Im}(\sigma_1(t)) = 1$. Hence

$$\begin{aligned} \int_{\sigma} f &= \int_0^2 f(\sigma_1(t)) |\sigma_1'(t)| dt \\ &= \int_0^2 dt \\ &= 2. \end{aligned}$$

Now we calculate $\int_{\sigma} f$ along the path σ using the parametrisation σ_2 . Note that $\sigma_2'(t) = 2t - 1$ and $\text{Im}(\sigma_2(t)) = 1$. Hence

$$\begin{aligned} \int_{\sigma} f &= \int_1^2 f(\sigma_2(t)) |\sigma_2'(t)| dt \\ &= \int_1^2 (2t - 1) dt \\ &= t^2 - t \Big|_{t=1}^2 \\ &= (4 - 2) - (1 - 1) \\ &= 2. \end{aligned}$$

In this example, calculating $\int_{\sigma} f$ using the second parametrisation was only marginally harder than using the first parametrisation. For more complicated paths, the choice between a ‘good’ and a ‘bad’ parametrisation can make the difference between an integral that is easy to calculate and one that is impossible using standard functions!

Solution 2.2

- (i) Choose $\sigma : [a, 1] \rightarrow \mathbb{H}$ given by $\sigma(t) = it$. Then clearly $\sigma(a) = ia$ and $\sigma(1) = i$ (so that $\sigma(\cdot)$ has the required end-points) and $\sigma(t)$ belongs to the imaginary axis. (Note there are many choices of parametrisations, your answer is correct as long as your parametrisation has the correct end-points and belongs to the imaginary axis.)
- (ii) For the parametrisation given above, $|\sigma'(t)| = 1$ and $\text{Im}(\sigma(t)) = t$. Hence

$$\text{length}_{\mathbb{H}}(\sigma) = \int_a^1 \frac{1}{t} dt = \log t \Big|_a^1 = -\log a = \log 1/a.$$

Solution 2.3

The idea is simple: The distance between two points is the infimum of the (hyperbolic) lengths of (piecewise continuously differentiable) paths between them. Only a subset of these paths pass through a third point; hence the infimum of this subset is greater than the infimum over all paths.

Let $x, y, z \in \mathbb{H}$. Let $\sigma_{x,y} : [a, b] \rightarrow \mathbb{H}$ be a path from x to y and let $\sigma_{y,z} : [b, c] \rightarrow \mathbb{H}$ be a path from y to z . Then the path $\sigma_{x,z} : [a, c] \rightarrow \mathbb{H}$ formed by defining

$$\sigma_{x,z}(t) = \begin{cases} \sigma_{x,y}(t) & \text{for } t \in [a, b] \\ \sigma_{y,z}(t) & \text{for } t \in [b, c] \end{cases}$$

is a path from x to z and has length equal to the sum of the lengths of $\sigma_{x,y}, \sigma_{y,z}$. Hence

$$d_{\mathbb{H}}(x, z) \leq \text{length}_{\mathbb{H}}(\sigma_{x,z}) = \text{length}_{\mathbb{H}}(\sigma_{x,y}) + \text{length}_{\mathbb{H}}(\sigma_{y,z}).$$

Taking the infima over path from x to y and from y to z we see that $d_{\mathbb{H}}(x, z) \leq d_{\mathbb{H}}(x, y) + d_{\mathbb{H}}(y, z)$.

Solution 3.1

For a straight line we have $\alpha = 0$, i.e. $\beta z + \bar{\beta}\bar{z} + \gamma = 0$.

Recall that the line $ax + by + c = 0$ has gradient $-a/b$, x -intercept $-c/a$ and y -intercept $-c/b$. Let $z = x + iy$ so that $x = (z + \bar{z})/2$ and $y = (z - \bar{z})/2i$. Substituting these into $ax + by + c$ we see that $\beta = (a - ib)/2$ and $\gamma = c$. Hence the gradient is $\text{Re}(\beta)/\text{Im}(\beta)$, the x -intercept is at $-\gamma/2\text{Re}(\beta)$ and the y -intercept is at $\gamma/2\text{Im}(\beta)$.

Solution 3.2

A circle with centre z_0 and radius r has equation $|z - z_0|^2 - r^2 = 0$. Multiplying this out (see the proof of Proposition 3.3.1) we have:

$$z\bar{z} - \bar{z}_0z - z_0\bar{z} + |z_0|^2 - r^2 = 0$$

and multiplying by $\alpha \in \mathbb{R}$ we have

$$\alpha z\bar{z} - \alpha\bar{z}_0z - \alpha z_0\bar{z} + \alpha|z_0|^2 - \alpha r^2 = 0.$$

Comparing the coefficients of this with $\alpha z\bar{z} + \beta z + \bar{\beta}\bar{z} + \gamma = 0$ we see that $\beta = -\alpha\bar{z}_0$ and $\gamma = \alpha|z_0|^2 - \alpha r^2$. Hence the centre of the circle is $z_0 = -\bar{\beta}/\alpha$ and the radius is given by

$$r = \sqrt{|z_0|^2 - \frac{\gamma}{\alpha}} = \sqrt{\frac{|\beta|^2}{\alpha^2} - \frac{\gamma}{\alpha}}.$$

Solution 3.3

We first show that γ maps \mathbb{H} to itself, i.e. if $z \in \mathbb{H}$ then $\gamma(z) \in \mathbb{H}$. To see this, let $z = u + iv \in \mathbb{H}$. Then $\text{Im}(z) = v > 0$. Let $\gamma(z) = (az + b)/(cz + d)$ be a Möbius transformation of \mathbb{H} . Then

$$\gamma(z) = \frac{a(u + iv) + b}{c(u + iv) + d} = \frac{(au + b + iav)(cu + d - icv)}{(cu + d + icv)(cu + d - icv)},$$

which has imaginary part

$$\frac{1}{|cz + d|^2}(-cv(au + b) + (cu + d)av) = \frac{1}{|cz + d|^2}(ad - bc)v$$

which is positive. Hence γ maps \mathbb{H} to itself.

If $\gamma(z) = (az + b)/(cz + d)$ then letting $w = (az + b)/(cz + d)$ and solving for z in terms of w shows that $\gamma^{-1}(z) = (dz - b)/(-cz + a)$. Hence γ^{-1} exists and so γ is a bijection.

Solution 3.4

(i) If $\gamma_1 = (a_1z + b_1)/(c_1z + d_1)$ and $\gamma_2 = (a_2z + b_2)/(c_2z + d_2)$ then their composition is

$$\begin{aligned}\gamma_2\gamma_1(z) &= \frac{a_2\left(\frac{a_1z+b_1}{c_1z+d_1}\right) + b_2}{c_2\left(\frac{a_1z+b_1}{c_1z+d_1}\right) + d_2} \\ &= \frac{(a_2a_1 + b_2c_1)z + (a_2b_1 + b_2d_1)}{(c_2a_1 + d_2c_1)z + (c_2b_1 + d_2d_1)},\end{aligned}$$

which is a Möbius transformation of \mathbb{H} as

$$\begin{aligned}(a_2a_1 + b_2c_1)(c_2b_1 + d_2d_1) - (a_2b_1 + b_2d_1)(c_2a_1 + d_2c_1) \\ = (a_1d_1 - b_1c_1)(a_2d_2 - b_2c_2) > 0.\end{aligned}$$

(ii) Composition of functions is associative.

(iii) The identity map $z \mapsto z$ is a Möbius transformation of \mathbb{H} (take $a = d = 1, b = c = 0$).

(iv) It follows from the solution to Exercise 3.3 that if γ is a Möbius transformation of \mathbb{H} then so is γ^{-1} .

Solution 3.5

Let $\gamma(z) = (az + b)/(cz + d)$.

For the dilation $z \mapsto kz$ take $a = k, b = 0, c = 0, d = 1$. Then $ad - bc = k > 0$ so that γ is a Möbius transformation of \mathbb{H} .

For the translation $z \mapsto z + b$ take $a = 0, b = b, c = 0, d = 1$. Then $ad - bc = 1 > 0$ so that γ is a Möbius transformation of \mathbb{H} .

For the inversion $z \mapsto -1/z$ take $a = 0, b = -1, c = 1, d = 0$. Then $ad - bc = 1 > 0$ so that γ is a Möbius transformation of \mathbb{H} .

Solution 4.1

To see that γ maps $\partial\mathbb{H}$ to itself bijectively, it is sufficient to find an inverse. Notice that $\gamma^{-1}(z) = (dz - b)/(-cz + a)$ (defined appropriately for $z = \infty$, namely we set $\gamma^{-1}(\infty) = -d/c$) is an inverse for γ .

Solution 4.2

Let $\gamma(z) = (az + b)/(cz + d)$. Then

$$\gamma'(z) = \frac{(cz + d)a - (az + b)c}{(cz + d)^2} = \frac{ad - bc}{(cz + d)^2}$$

so that

$$|\gamma'(z)| = \frac{ad - bc}{|cz + d|^2}.$$

To calculate the imaginary part of $\gamma(z)$, write $z = x + iy$. Then

$$\gamma(z) = \frac{a(x + iy) + b}{c(x + iy) + d} = \frac{(ax + b + iay)(cx + d - icy)}{(cx + d + icy)(cx + d - icy)},$$

which has imaginary part

$$\begin{aligned} \operatorname{Im} \gamma(z) &= \frac{1}{|cz + d|^2} (-cy(ax + b) + (cx + d)ay) \\ &= \frac{1}{|cz + d|^2} (ad - bc)y \\ &= \frac{1}{|cz + d|^2} (ad - bc) \operatorname{Im}(z). \end{aligned}$$

Solution 4.3

Let $z = x + iy$ and define $\gamma(z) = -x + iy$.

(i) Suppose that $\gamma(z_1) = \gamma(z_2)$. Write $z_1 = x_1 + iy_1$, $z_2 = x_2 + iy_2$. Then $-x_1 + iy_1 = -x_2 + iy_2$. Hence $x_1 = x_2$ and $y_1 = y_2$, so that $z_1 = z_2$. Hence γ is injective. Let $z = x + iy \in \mathbb{H}$. take $w = -x + iy$. Then $\gamma(w) = -(-x) + iy = x + iy = z$. Hence γ is surjective. Hence γ is a bijection.

(ii) Let $\sigma(t) = \sigma_1(t) + i\sigma_2(t) : [a, b] \rightarrow \mathbb{H}$ be a piecewise continuously differentiable path in \mathbb{H} . Note that

$$\gamma \circ \sigma(t) = -\sigma_1(t) + i\sigma_2(t).$$

Hence

$$\begin{aligned} \operatorname{length}_{\mathbb{H}}(\gamma \circ \sigma) &= \int_a^b \frac{1}{|\operatorname{Im} \gamma \circ \sigma(t)|} \sqrt{(-\sigma_1'(t))^2 + (\sigma_2'(t))^2} dt \\ &= \int_a^b \frac{1}{\sigma_2(t)} |\sigma'(t)| dt \\ &= \operatorname{length}_{\mathbb{H}}(\sigma). \end{aligned}$$

Let $z, w \in \mathbb{H}$. Note that σ is a piecewise continuously differentiable path from z to w if and only if $\gamma \circ \sigma$ is a piecewise continuously differentiable path from $\gamma(z)$ to $\gamma(w)$. Hence

$$\begin{aligned} d_{\mathbb{H}}(\gamma(z), \gamma(w)) &= \inf\{\operatorname{length}_{\mathbb{H}}(\gamma \circ \sigma) \mid \sigma \text{ is a piecewise continuously} \\ &\quad \text{differentiable path from } z \text{ to } w\} \\ &= \inf\{\operatorname{length}_{\mathbb{H}}(\sigma) \mid \sigma \text{ is a piecewise continuously} \\ &\quad \text{differentiable path from } z \text{ to } w\} \\ &= d_{\mathbb{H}}(z, w). \end{aligned}$$

Hence γ is an isometry of \mathbb{H} .

Solution 4.4

Let $H_1, H_2 \in \mathcal{H}$. Then there exists $\gamma_1 \in \operatorname{Möb}(\mathbb{H})$ such that $\gamma_1(H_1)$ is the imaginary axis. Similarly, there exists $\gamma_2 \in \operatorname{Möb}(\mathbb{H})$ such that $\gamma_2(H_2)$ is the imaginary axis. Hence γ_2^{-1}

maps the imaginary axis to H_2 . Hence $\gamma_2^{-1} \circ \gamma_1$ is a Möbius transformation of \mathbb{H} that maps H_1 to H_2 .

Solution 5.1

By Lemma 5.2.1 we can find a Möbius transformation γ_1 of \mathbb{H} that maps H_1 to the imaginary axis and z_1 to i and a Möbius transformation γ_2 of \mathbb{H} that maps H_2 to the imaginary axis and z_2 to i . The composition of two Möbius transformations of \mathbb{H} is a Möbius transformation of \mathbb{H} . Hence $\gamma_2^{-1} \circ \gamma_1$ is a Möbius transformation of \mathbb{H} that maps H_1 to H_2 and z_1 to z_2 .

Solution 5.2

- (i) The geodesic between $-3 + 4i$ to $-3 + 5i$ is the arc of vertical straight line between them. It has equation $z + \bar{z} + 6 = 0$.
- (ii) Both $-3 + 4i$ and $3 + 4i$ lie on the circle in \mathbb{C} with centre 0 and radius 5. Hence the geodesic between $-3 + 4i$ and $3 + 4i$ is the arc of semi-circle of radius 5 centre 0 between them. It has equation $z\bar{z} - 5^2 = 0$.
- (iii) Clearly the geodesic between $-3 + 4i$ and $5 + 12i$ is not a vertical straight line. Hence it must have an equation of the form $z\bar{z} + \beta z + \beta\bar{z} + \gamma = 0$. Substituting the two values of $z = -3 + 4i, 5 + 12i$ we obtain two simultaneous equations:

$$25 - 6\beta + \gamma = 0, 169 + 10\beta + \gamma = 0$$

which can be solved to give $\beta = -9, \gamma = -79$.

Solution 5.3

- (i) Let γ be a Möbius transformation of \mathbb{H} . As γ is an isometry, by Proposition 4.1.1 we know that

$$\cosh d_{\mathbb{H}}(\gamma(z), \gamma(w)) = \cosh d_{\mathbb{H}}(z, w).$$

Hence $\text{LHS}(\gamma(z), \gamma(w)) = \text{LHS}(z, w)$.

By Exercise 4.2 we know that if γ is a Möbius transformation then $\text{Im}(\gamma(z)) = |\gamma'(z)| \text{Im}(z)$. By Lemma 5.5.1 it follows that

$$\begin{aligned} 1 + \frac{|\gamma(z) - \gamma(w)|^2}{2 \text{Im}(\gamma(z)) \text{Im}(\gamma(w))} &= 1 + \frac{|z - w|^2 |\gamma'(z)| |\gamma'(w)|}{2 |\gamma'(z)| \text{Im}(z) |\gamma'(w)| \text{Im}(w)} \\ &= 1 + \frac{|z - w|^2}{2 \text{Im}(z) \text{Im}(w)}. \end{aligned}$$

Hence $\text{RHS}(\gamma(z), \gamma(w)) = \text{RHS}(z, w)$.

- (ii) Let H be the geodesic passing through z and w . Then by Lemma 4.3.1 there exists a Möbius transformation γ of \mathbb{H} mapping H to the imaginary axis. Let $\gamma(z) = ia$ and $\gamma(w) = ib$. By interchanging z and w if necessary, we can assume that $a < b$. Then

$$\begin{aligned} \text{LHS}(\gamma(z), \gamma(w)) &= \cosh d_{\mathbb{H}}(\gamma(z), \gamma(w)) \\ &= \cosh d_{\mathbb{H}}(ia, ib) \\ &= \cosh \log b/a \\ &= \frac{e^{\log b/a} + e^{\log a/b}}{2} \\ &= \frac{b/a + a/b}{2} = \frac{b^2 + a^2}{2ab}. \end{aligned}$$

Moreover,

$$\begin{aligned} \text{RHS}(\gamma(z), \gamma(w)) &= \text{RHS}(ia, ib) \\ &= 1 + \frac{|ia - ib|^2}{2ab} \\ &= 1 + \frac{(b - a)^2}{2ab} \\ &= \frac{b^2 + a^2}{2ab}. \end{aligned}$$

Hence $\text{LHS}(\gamma(z), \gamma(w)) = \text{RHS}(\gamma(z), \gamma(w))$.

- (iii) For any two points z, w let H denote the geodesic containing both z, w . Choose a Möbius transformation γ of \mathbb{H} that maps H to the imaginary axis. Then

$$\text{LHS}(z, w) = \text{LHS}(\gamma(z), \gamma(w)) = \text{RHS}(\gamma(z), \gamma(w)) = \text{RHS}(z, w).$$

Solution 5.4

Let $C = \{w \in \mathbb{H} \mid d_{\mathbb{H}}(z, w) = r\}$ be a hyperbolic circle with centre $z \in \mathbb{H}$ and radius $r > 0$. Recall

$$\cosh d_{\mathbb{H}}(z, w) = 1 + \frac{|z - w|^2}{2 \text{Im}(z) \text{Im}(w)}.$$

Let $z = x_0 + iy_0$ and $w = x + iy$. Then

$$\cosh r = 1 + \frac{(x - x_0)^2 + (y - y_0)^2}{2y_0y}$$

which can be simplified to

$$(x - x_0)^2 + (y - y_0 \cosh r)^2 + y_0^2 - y_0^2 \cosh^2 r = 0$$

which is the equation of a Euclidean circle with centre $(x_0, y_0 \cosh r)$ and radius $y_0 \sqrt{\cosh^2 r - 1} = y_0 \sinh r$.

Solution 5.5

- (i) Let $\sigma : [a, b] \rightarrow \mathbb{H}$ be any piecewise continuously differentiable path. As we are assuming $\text{length}_{\rho}(\sigma) = \text{length}_{\rho}(\gamma \circ \sigma)$ we have

$$\begin{aligned} \int_a^b \rho(\sigma(t)) |\sigma'(t)| dt &= \text{length}_{\rho}(\sigma) \\ &= \text{length}_{\rho}(\gamma \circ \sigma) \\ &= \int_a^b \rho(\gamma(\sigma(t))) |(\gamma(\sigma(t)))'| dt \\ &= \int_a^b \rho(\gamma(\sigma(t))) |\gamma'(\sigma(t))| |\sigma'(t)| dt \end{aligned}$$

where we have used the chain rule to obtain the last equality. Hence

$$\int_a^b (\rho(\gamma(\sigma(t))) |\gamma'(\sigma(t))| - \rho(\sigma(t))) |\sigma'(t)| dt = 0.$$

Using the hint, we see that

$$\rho(\gamma(z))|\gamma'(z)| = \rho(z) \quad (30.1)$$

for all $z \in \mathbb{H}$.

(ii) Take $\gamma(z) = z + b$ in (30.1). Then $|\gamma'(z)| = 1$. Hence

$$\rho(z + b) = \rho(z)$$

for all $b \in \mathbb{R}$. Hence $\rho(z)$ depends only the imaginary part of z . Write $\rho(z) = \rho(y)$ where $z = x + iy$.

(iii) Take $\gamma(z) = kz$ in (30.1). Then $|\gamma'(z)| = k$. Hence

$$k\rho(ky) = \rho(y).$$

Setting $y = 1$ and letting $c = \rho(1)$ we have that $\rho(k) = \rho(1)/k = c/k$. Hence $\rho(z) = c/\text{Im}(z)$.

Solution 5.6

(i) Draw in the tangent lines to the circles at the point of intersection; then θ is the angle between these two tangent lines.

Draw the (Euclidean!) triangle with vertices at the point of intersection and the two centres. See Figure 30.1. The internal angle of this triangle at the point of intersection is split into three; the middle part is equal to θ . Recall that a radius of a circle meets the tangent to a circle at right-angles. Hence both the remaining two parts of the angle in the triangle at the point of intersection is given by $\pi/2 - \theta$. Hence the triangle has angle $\pi/2 - \theta + \theta + \pi/2 - \theta = \pi - \theta$ at the vertex corresponding to the point of intersection.

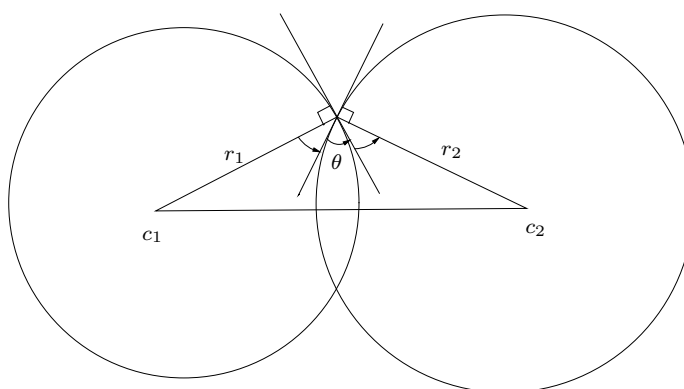

Figure 30.1: The Euclidean triangle with vertices at c_1, c_2 and the point of intersection

The cosine rule gives the required formula (recall that $\cos \pi - \theta = -\cos \theta$).

- (ii) The points -6 and 6 clearly lie on the semi-circle with centre 0 and radius 6 . Similarly, the points $4\sqrt{2}$ and $6\sqrt{2}$ clearly lie on the semi-circle with centre $5\sqrt{2}$ and radius $\sqrt{2}$.

(If you can't determine the geodesic by considering the geometry then you can find it as follows. We know geodesics have equations of the form $\alpha z\bar{z} + \beta z + \beta\bar{z} + \gamma = 0$ where $\alpha, \beta, \gamma \in \mathbb{R}$. The geodesic between $4\sqrt{2}$ and $6\sqrt{2}$ is clearly a semi-circle, and so $\alpha \neq 0$; we divide through by α to assume that $\alpha = 1$. Hence we are looking for an equation of the form $z\bar{z} + \beta z + \beta\bar{z} + \gamma = 0$. Substituting first $z = 4\sqrt{2}$ and then $z = 6\sqrt{2}$ we obtain the simultaneous equations $32 + 8\sqrt{2}\beta + \gamma = 0$, $72 + 12\sqrt{2}\beta + \gamma = 0$. Solving these gives $\beta = -5\sqrt{2}$, $\gamma = 48$. Putting $z = x + iy$ we thus have the equation $x^2 + y^2 - 10\sqrt{2}x + 48 = 0$. Completing the square gives $(x - 5\sqrt{2})^2 + y^2 = (\sqrt{2})^2$, so that we have a semi-circle in \mathbb{C} with centre $5\sqrt{2}$ and radius $\sqrt{2}$.)

Part (i) allows us to calculate the angle ψ in Figure 30.2. Substituting $c_1 = 0$, $r_1 = 6$,

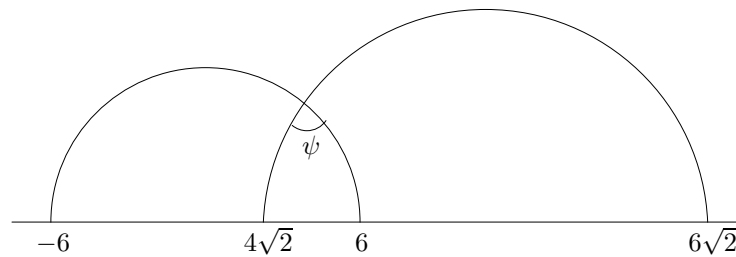

Figure 30.2: The angle ψ

$c_2 = 5\sqrt{2}$, $r_2 = \sqrt{2}$ into the result from (i) shows that $\cos \psi = 1/\sqrt{2}$ so that $\psi = \pi/4$. The angle in Figure 5.6 that we want to calculate is $\phi = \pi - \psi = 3\pi/4$.

Solution 5.7

Suppose that the semi-circular geodesic has centre at $x \in \mathbb{R}$ and radius r . Construct the (Euclidean) right-angled triangle with vertices $x, 0, ib$, as illustrated in Figure 30.3. As

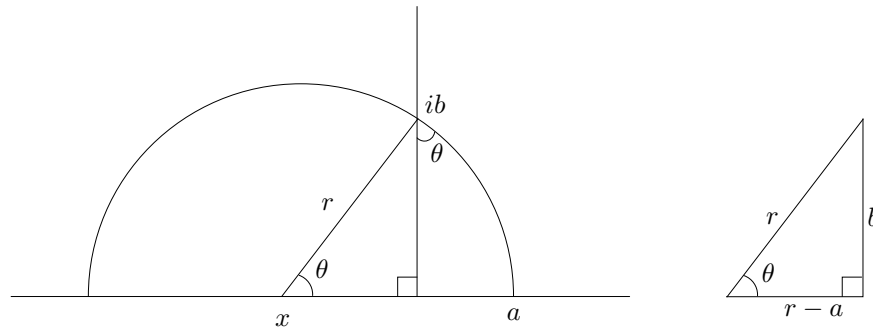

Figure 30.3: The (Euclidean) triangle with vertices at $x, 0, ib$

the radius of the semicircle is r , we have that $|x - ib| = r$ and $|x - a| = r$; hence the base of the right-angled triangle has length $r - a$. By Pythagoras' Theorem, we have that $(r - a)^2 + b^2 = r^2$. Expanding this out and simplifying it we have $r = (a^2 + b^2)/2a$. From

Figure 30.3 we also have that

$$\sin \theta = \frac{b}{r}, \quad \cos \theta = \frac{r-a}{r}$$

and the result follows after substituting in $r = (a^2 + b^2)/2a$.

Solution 6.1

- (i) First note that h is a bijection from \mathbb{H} to its image because it has an inverse $g(z) = (-z + i)/(-iz + 1)$.

We now show that $h(\mathbb{H}) = \mathbb{D}$. Let $z = u + iv \in \mathbb{H}$ so that $v > 0$. Now

$$\begin{aligned} h(z) &= \frac{u + iv - i}{i(u + iv) - 1} \\ &= \frac{u + i(v-1)}{-(v+1) + iu} \frac{-(v+1) - iu}{-(v+1) - iu} \\ &= \frac{-2u + i(1 - u^2 - v^2)}{(v+1)^2 + u^2}. \end{aligned}$$

To show that $h(\mathbb{H}) = \mathbb{D}$ it remains to show that the above complex number has modulus less than 1. To see this first note that:

$$\begin{aligned} (2u)^2 + (1 - u^2 - v^2)^2 &= u^4 + 2u^2 + 1 - 2v^2 + 2u^2v^2 + v^4 \end{aligned} \quad (30.2)$$

$$\begin{aligned} ((v+1)^2 + u^2)^2 &= v^4 + 4v^3 + 6v^2 + 4v + 1 \\ &\quad + 2u^2v^2 + 4u^2v + 2u^2 + u^4. \end{aligned} \quad (30.3)$$

To prove that $|h(z)| < 1$ it is sufficient to check that (30.2) < (30.3). By cancelling terms, it is sufficient to check that

$$-2v^2 < 4v^3 + 6v^2 + 4v + 4u^2v.$$

This is true because the left-hand side is clearly negative, whereas the right-hand side is positive, using the fact that $v > 0$.

To show that h maps $\partial\mathbb{H}$ bijectively to $\partial\mathbb{D}$ note that for $u \in \mathbb{R}$

$$h(u) = \frac{-2u + i(1 - u^2)}{u^2 + 1}$$

which is easily seen to have modulus one (and so is a point on $\partial\mathbb{D}$). Note that $h(\infty) = -i$ and that $h(u) \neq -i$ if u is real. Hence h is a bijection from $\partial\mathbb{H}$ to $\partial\mathbb{D}$.

- (ii) We have already seen that $g(z) = h^{-1}(z) = (-z + i)/(-iz + 1)$. Calculating $g'(z)$ is easy. To calculate $\text{Im}(g(z))$ write $z = u + iv$ and compute.

(iii) Let $\sigma(t) = t$, $0 \leq t \leq x$. Then σ is a path from 0 to x and it has length

$$\begin{aligned} \int_{\sigma} \frac{2}{1-|z|^2} &= \int_0^x \frac{2}{1-t^2} dt \\ &= \int_0^x \frac{1}{1-t} + \frac{1}{1+t} dt \\ &= \log \frac{1+x}{1-x}. \end{aligned}$$

To show that this is the optimal length of a path from 0 to x (and thus that the real-axis is a geodesic) we have to show that any other path from 0 to x has a larger length.

Let $\sigma(t) = x(t) + iy(t)$, $a \leq t \leq b$ be a path from 0 to x . Then it has length

$$\begin{aligned} &\int_a^b \frac{2}{1-|\sigma(t)|^2} |\sigma'(t)| dt \\ &= \int_a^b \frac{2}{1-(x(t)^2+y(t)^2)} \sqrt{x'(t)^2+y'(t)^2} dt \\ &\geq \int_a^b \frac{2}{1-x(t)^2} x'(t) dt \\ &= \int_a^b \frac{x'(t)}{1-x(t)} + \frac{x'(t)}{1+x(t)} dt \\ &= \log \frac{1+x(t)}{1-x(t)} \Big|_a^b \\ &= \log \frac{1+x}{1-x}, \end{aligned}$$

with equality precisely when $y'(t) = 0$ and $y(t) = 0$, i.e. with equality precisely when the path lies along the real axis.

Solution 6.2

Recall $h(z) = (z-i)/(iz-1)$ and $h^{-1}(z) = (-z+i)/(-iz+1)$. Let $\gamma(z) = (az+b)/(cz+d)$, $ad-bc > 0$, be a Möbius transformation of \mathbb{H} . We claim that $h\gamma h^{-1}$ is a Möbius transformation of \mathbb{D} .

To see this, first note that (after a *lot* of algebra!)

$$\begin{aligned} h\gamma h^{-1}(z) &= \frac{[a+d+i(b-c)]z + [-(b+c)-i(a-d)]}{[-(b+c)+i(a-d)]z + [a+d-i(b-c)]} \\ &= \frac{\alpha z + \beta}{\bar{\beta} z + \bar{\alpha}}. \end{aligned}$$

Finally, we must check that $|\alpha|^2 - |\beta|^2 > 0$ which is a simple calculation, using the fact that $ad-bc > 0$.

Solution 6.3

Let

$$\gamma_1(z) = \frac{\alpha_1 z + \beta_1}{\bar{\beta}_1 z + \bar{\alpha}_1}, \quad \gamma_2(z) = \frac{\alpha_2 z + \beta_2}{\bar{\beta}_2 z + \bar{\alpha}_2}$$

where $\alpha_1, \beta_1, \alpha_2, \beta_2 \in \mathbb{C}$ and $|\alpha_1|^2 - |\beta_1|^2 = 1$ and $|\alpha_2|^2 - |\beta_2|^2 = 1$. We want to show that $\gamma_1\gamma_2 \in \text{Möb}(\mathbb{D})$. Note that

$$\begin{aligned} \gamma_1(\gamma_2(z)) &= \frac{\alpha_1\gamma_2(z) + \beta_1}{\bar{\beta}_1\gamma_2(z) + \bar{\alpha}_1} \\ &= \frac{\alpha_1\left(\frac{\alpha_2z + \beta_2}{\beta_2z + \bar{\alpha}_2}\right) + \beta_1}{\bar{\beta}_1\left(\frac{\alpha_2z + \beta_2}{\beta_2z + \bar{\alpha}_2}\right) + \bar{\alpha}_1} \\ &= \frac{(\alpha_1\alpha_2 + \beta_1\bar{\beta}_2)z + (\alpha_1\beta_2 + \beta_1\bar{\alpha}_2)}{(\bar{\beta}_1\alpha_2 + \bar{\alpha}_1\bar{\beta}_2)z + (\bar{\beta}_1\beta_2 + \bar{\alpha}_1\bar{\alpha}_2)} \\ &= \frac{\alpha z + \beta}{\bar{\beta}z + \bar{\alpha}} \end{aligned}$$

where $\alpha = \alpha_1\alpha_2 + \beta_1\bar{\beta}_2$ and $\beta = \alpha_1\beta_2 + \beta_1\bar{\alpha}_2$. It is straightforward to check that

$$|\alpha|^2 - |\beta|^2 = (|\alpha_1|^2 - |\beta_1|^2)(|\alpha_2|^2 - |\beta_2|^2) > 0.$$

Hence $\gamma_1\gamma_2 \in \text{Möb}(\mathbb{D})$.

Suppose that

$$\frac{\alpha z + \beta}{\bar{\beta}z + \bar{\alpha}} = w.$$

Then

$$w = \frac{\bar{\alpha}z - \beta}{-\bar{\beta}z + \alpha}.$$

Hence

$$\gamma^{-1}(z) = \frac{\bar{\alpha}z - \beta}{-\bar{\beta}z + \alpha}$$

and it is easy to see that $\gamma^{-1} \in \text{Möb}(\mathbb{D})$.

Clearly the identity map $z \mapsto z$ is a Möbius transformation of \mathbb{D} (take $\alpha = 1, \beta = 0$).

Hence $\text{Möb}(\mathbb{D})$ is a group.

Solution 6.4

The map $h : \mathbb{H} \rightarrow \mathbb{D}$ defined in (6.1.1) maps geodesics in \mathbb{H} to geodesics in \mathbb{D} .

Suppose that $z \in \mathbb{H}$ lies on a geodesic. Then z lies on either a horizontal straight line or semi-circle with real centre with an equation of the form

$$\alpha z \bar{z} + \beta z + \beta \bar{z} + \gamma = 0.$$

Let $w = h(z)$. Then

$$z = \frac{-w + i}{-iw + 1}$$

so that

$$\bar{z} = \frac{-\bar{w} - i}{i\bar{w} + 1}.$$

Hence w satisfies an equation of the form

$$\alpha \frac{-w + i}{-iw + 1} \frac{-\bar{w} - i}{i\bar{w} + 1} + \beta \frac{-w + i}{-iw + 1} + \beta \frac{-\bar{w} - i}{i\bar{w} + 1} + \gamma = 0.$$

Equivalently, w satisfies an equation of the form

$$\alpha(-w+i)(-\bar{w}-i) + \beta(-w+i)(i\bar{w}+1) + \beta(-\bar{w}-i)(-iw+1) + \gamma(-iw+1)(i\bar{w}+1) = 0.$$

Multiplying this out and collecting terms we see that w satisfies an equation of the form

$$(\alpha + \gamma)w\bar{w} + (-2\beta + i(\alpha - \gamma))w + (-2\beta - i(\alpha - \gamma))\bar{w} + (\alpha + \gamma) = 0.$$

Let $\alpha' = \alpha + \gamma$, $\beta' = -2\beta + i(\alpha - \gamma)$. Then $\alpha' \in \mathbb{R}$ and $\beta' \in \mathbb{C}$. Moreover w satisfies an equation of the form

$$\alpha'w\bar{w} + \beta'w + \bar{\beta}'\bar{w} + \alpha' = 0.$$

Solution 6.5

By applying a Möbius transformation of \mathbb{D} , we can move the circle so that its centre is at the origin $0 \in \mathbb{D}$. (This uses the additional facts that (i) a hyperbolic circle is a Euclidean circle (but possibly with a different centre and radius), and (ii) Möbius transformations of \mathbb{D} map circles to circles.) As Möbius transformations of \mathbb{D} preserve lengths and area, this doesn't change the circumference nor the area.

Let $C_r = \{w \in \mathbb{D} \mid d_{\mathbb{D}}(0, w) = r\}$. By Proposition 6.2.1 and the fact that a rotation is a Möbius transformation of \mathbb{D} , we have that C_r is a Euclidean circle with centre 0 and radius R where

$$\frac{1+R}{1-R} = e^r.$$

Hence $R = (e^r - 1)/(e^r + 1) = \tanh(r/2)$.

Now

$$\text{circumference}(C_r) = \int_{\sigma} \frac{2}{1-|z|^2}$$

where $\sigma(t) = Re^{it}$, $0 \leq t \leq 2\pi$ is a path that describes the Euclidean circle of radius R , centred at 0. Now

$$\begin{aligned} \text{circumference}(C_r) &= \int_{\sigma} \frac{2}{1-|z|^2} \\ &= \int_0^{2\pi} \frac{2}{1-|\sigma(t)|^2} |\sigma'(t)| dt \\ &= \int_0^{2\pi} \frac{2R}{1-R^2} dt \\ &= \frac{4\pi R}{1-R^2} \end{aligned}$$

and substituting for R in terms of r gives that the circumference of C_r is $2\pi \sinh r$.

Similarly, the area of C_r is given by

$$\text{Area}_{\mathbb{D}}(C_r) = \int \int_{D_r} \frac{4}{(1-|z|^2)^2} dz$$

where $D_r = \{w \in \mathbb{D} \mid d_{\mathbb{D}}(0, w) \leq r\}$ is the disc of hyperbolic radius r with centre 0. Now D_r is the Euclidean disc of radius $R = \tanh(r/2)$ centred at 0. Recall that when integrating

using polar co-ordinates, the area element is $\rho d\rho d\theta$. Then

$$\begin{aligned} \text{Area}_{\mathbb{D}}(C_r) &= \int_{\theta=0}^{2\pi} \int_{\rho=0}^R \frac{4}{(1-\rho^2)^2} \rho d\rho d\theta \\ &= 4\pi \left. \frac{1}{1-\rho^2} \right|_{\rho=0}^R \\ &= 4\pi \frac{R^2}{1-R^2} \\ &= 4\pi \sinh^2 r/2. \end{aligned}$$

Solution 7.1

- (i) Clearly both $(-1 + i\sqrt{3})/2$ and $(1 + i\sqrt{3})/2$ lie on the unit circle in \mathbb{C} with centre 0 and radius 1.

One can determine the other two geodesics by recognition; alternatively one can argue as follows. Consider $0, (-1 + i\sqrt{3})/2$. These two points lie on a geodesic given by a semi-circle with equation $z\bar{z} + \beta z + \beta\bar{z} + \gamma = 0$. Substituting these two values of z in gives the simultaneous equations $\gamma = 0, 1 - \beta + \gamma = 0$. Hence $\beta = 1, \gamma = 0$. Hence the equation of the geodesic through $0, (-1 + i\sqrt{3})/2$ is given by $z\bar{z} + z + \bar{z} = 0$. Writing $z = x + iy$ this becomes $x^2 + y^2 + 2x = 0$. Completing the square gives $(x + 1)^2 + y^2 = 1$. Hence $0, (-1 + i\sqrt{3})/2$ lie on the circle in \mathbb{C} with centre -1 and radius 1.

A similar calculation shows that $0, (1 + i\sqrt{3})/2$ lie on the circle in \mathbb{C} with centre 1 and radius 1.

- (ii) As the vertex 0 is on the boundary of \mathbb{H} , the internal angle is 0.

We can calculate the angles ψ_1, ψ_2 in Figure 30.4 using Exercise 5.6. We obtain

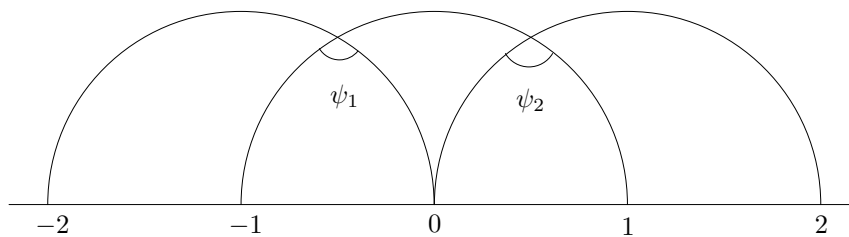

Figure 30.4: The angles ψ_1, ψ_2

$$\cos \psi_1 = \frac{(0 - 1)^2 - (1^2 + 1^2)}{2} = -\frac{1}{2}$$

so that $\psi_1 = 2\pi/3$. As $\theta_1 = \pi - \psi_1$ we have $\theta_1 = \pi/3$.

Similarly, $\theta_2 = \pi/3$.

By the Gauss-Bonnet Theorem, the area of the triangle is $\pi - (0 + \pi/3 + \pi/3) = \pi/3$.

Solution 7.2

Let Q be a hyperbolic quadrilateral with vertices A, B, C, D (labelled, say, anti-clockwise) and corresponding internal angles $\alpha, \beta, \gamma, \delta$. Construct the geodesic from A to C , creating triangles ABC (with internal angles $\alpha_1, \beta, \gamma_1$) and CDA (with internal angles $\gamma_2, \delta, \alpha_2$), where $\alpha_1 + \alpha_2 = \alpha$ and $\gamma_1 + \gamma_2 = \gamma$. By the Gauss-Bonnet Theorem

$$\begin{aligned} \text{Area}_{\mathbb{H}}(Q) &= \text{Area}_{\mathbb{H}}(ABC) + \text{Area}_{\mathbb{H}}(CDA) \\ &= \pi - (\alpha_1 + \beta + \gamma_1) + \pi - (\alpha_2 + \beta + \gamma_2) \\ &= 2\pi - (\alpha + \beta + \gamma + \delta). \end{aligned}$$

Solution 7.3

Let $D(r)$ be the hyperbolic polygon with vertices at $r, r\omega, \dots, r\omega^{n-1}$. Let $\alpha_j(r)$ denote the internal angle at vertex $r\omega^j$. For each $0 \leq k \leq n-1$, consider the Möbius transformation of \mathbb{D} given by $\gamma_k(z) = \omega^k z$; this rotates the polygon so that vertex v_i is mapped to vertex v_{i+k} . Thus $\gamma_k(D(r)) = D(r)$. As Möbius transformations of \mathbb{D} preserve angles, this shows that the internal angle at vertex v_1 is equal to the internal angle at vertex v_{1+k} . By varying k , we see that all internal angles are equal.

By the Gauss-Bonnet Theorem, we see that

$$\text{Area}_{\mathbb{H}}D(r) = (n-2)\pi - n\alpha(r).$$

Notice that $D(r)$ is contained in $C(r)$, the hyperbolic disc with hyperbolic centre 0 and Euclidean radius r . By (the solution to) Exercise 6.5, we see that

$$\begin{aligned} \lim_{r \rightarrow 0} \text{Area}_{\mathbb{H}}D(r) &\leq \lim_{r \rightarrow 0} \text{Area}_{\mathbb{H}}C(r) \\ &= \lim_{r \rightarrow 0} \frac{4\pi r^2}{1-r^2} = 0. \end{aligned}$$

Hence

$$\lim_{r \rightarrow 0} \alpha(r) = \frac{(n-2)\pi}{n}.$$

As $r \rightarrow 1$, each vertex $r\omega^k \rightarrow \omega^k \in \partial\mathbb{D}$. The internal angle at a vertex on the boundary is equal to 0. Hence $\lim_{r \rightarrow 1} \alpha(r) = 0$.

Hence given any $\alpha \in [0, (n-2)\pi/n)$, we can find a value of r for which $\alpha = \alpha(r)$, and hence construct a regular n -gon with internal angle α .

Conversely, suppose that D is a regular hyperbolic polygon with each internal angle $\alpha \geq (n-2)\pi/n$. Then we have that $n\alpha \geq (n-2)\pi$. By the Gauss-Bonnet Theorem,

$$\text{Area}_{\mathbb{H}}D = (n-2)\pi - n\alpha \leq (n-2)\pi - (n-2)\pi = 0.$$

As area must be positive, this is a contradiction.

Solution 7.4

(Not examinable—included for interest only!)

Clearly $n \geq 3$ and $k \geq 3$.

The internal angle of a regular (Euclidean) n -gon is $(n-2)\pi/n$. Suppose that k n -gons meet at each vertex. As the polyhedron is convex, the angle sum must be less than 2π . Hence

$$k \frac{(n-2)\pi}{n} < 2\pi.$$

Rearranging this and completing the square gives $(k-2)(n-2) < 4$. As n, k are integers greater than 3, we must have that either $n = 3$ or $k = 3$. It is easy to see that the only possibilities are $(n, k) = (3, 3), (3, 4), (3, 5), (4, 3)$ and $(5, 3)$, as claimed.

Solution 8.1

First note that

$$\begin{aligned}\cos^2 \alpha &= \frac{1}{1 + \tan^2 \alpha} \\ &= \frac{1}{1 + \frac{\tanh^2 a}{\sinh^2 b}} \\ &= \frac{\sinh^2 b}{\sinh^2 b + \tanh^2 a}.\end{aligned}$$

Now using the facts that $\cosh c = \cosh a \cosh b$ and $\tanh^2 a = 1 - 1/\cosh^2 a$ we see that

$$\tanh^2 a = 1 - \frac{\cosh^2 b}{\cosh^2 c}.$$

Substituting this into the above equality gives

$$\begin{aligned}\cos^2 \alpha &= \frac{\sinh^2 b}{\sinh^2 b + 1 - \frac{\cosh^2 b}{\cosh^2 c}} \\ &= \frac{\tanh^2 b}{\tanh^2 c}\end{aligned}$$

(after some manipulation, using the fact that $\cosh^2 - \sinh^2 = 1$).

To see that $\sin \beta = \sinh b / \sinh c$ we multiply the above equation and the equation given in Proposition 8.2.1 together to obtain

$$\begin{aligned}\sin \alpha &= \frac{\tanh b \tanh a}{\tanh c \sinh} \\ &= \frac{\sinh b \cosh c \sinh a}{\cosh b \sinh c \cosh a \sinh b} \\ &= \frac{\sinh a}{\sinh c},\end{aligned}$$

using the fact that $\cosh c = \cosh a \cosh b$.

Solution 8.2

We prove the first identity. By Proposition 8.2.1 we know that

$$\cos \alpha = \frac{\tanh b}{\tanh c}, \quad \sin \beta = \frac{\sinh b}{\sinh c}.$$

Hence

$$\frac{\cos \alpha}{\sin \beta} = \frac{\tanh b \sinh c}{\tanh c \sinh b} = \frac{\cosh c}{\cosh b} = \cosh a,$$

using the hyperbolic version of Pythagoras' Theorem.

We prove the second identity. By Proposition 8.2.1 we have that

$$\tan \alpha = \frac{\tanh a}{\sinh b}, \quad \tan \beta = \frac{\tanh b}{\sinh a}.$$

Hence

$$\cot \alpha \cot \beta = \frac{\sinh a \sinh b}{\tanh b \tanh a} = \cosh a \cosh b = \cosh c,$$

by the hyperbolic version of Pythagoras' Theorem.

Take a Euclidean right-angled triangle with sides of length a, b and c , with c being the hypotenuse. Let α be the angle opposite a and β opposite b . Then $\cos \alpha = b/c$ and $\sin \beta = b/c$ so that

$$\cos \alpha \operatorname{cosec} \beta = 1.$$

As in a Euclidean triangle the angles sum to π , we must have that $\beta = \pi/2 - \alpha$. Hence the above identity says that $\sin(\pi/2 - \alpha) = \cos \alpha$.

Similarly, we have that $\tan \alpha = a/b$ and $\tan \beta = b/a$. Hence

$$\cot \alpha \cot \beta = 1.$$

Again, this can be re-written as $\tan(\pi/2 - \alpha) = 1/\tan \alpha$.

Solution 8.3

Note that

$$\cos \alpha = \sqrt{1 - \sin^2 \alpha} = \sqrt{1 - \frac{1}{\cosh^2 a}} = \frac{\sinh a}{\cosh a} = \frac{1}{\tanh a}.$$

Hence

$$\tan \alpha = \frac{\sin \alpha}{\cos \alpha} = \frac{1}{\cosh a} \frac{\cosh a}{\sinh a} = \frac{1}{\sinh a}.$$

Solution 8.4

Label the vertices A, B and C so that the angle at A is α , etc. By applying a Möbius transformation of \mathbb{H} we may assume that none of the sides of Δ are segments of vertical lines. Construct a geodesic from vertex B to the geodesic segment $[A, C]$ in such a way that these geodesics meet at right-angles. This splits Δ into two right-angled triangles, BDA and BDC . Let the length of the geodesic segment $[B, D]$ be d , and suppose that BDA has internal angles $\beta_1, \pi/2, \alpha$ and side lengths d, b_1, c , as in the figure. Label BDC similarly. See Figure 30.5.

From Proposition 8.2.1 we know that

$$\sin \beta_1 = \frac{\sinh b_1}{\sinh c}, \quad \cos \beta_1 = \frac{\tanh d}{\tanh c}, \quad \sin \beta_2 = \frac{\sinh b_2}{\sinh a}, \quad \cos \beta_2 = \frac{\tanh d}{\tanh a}.$$

By the hyperbolic version of Pythagoras' Theorem we know that

$$\cosh c = \cosh b_1 \cosh d, \quad \cosh a = \cosh b_2 \cosh d.$$

Hence

$$\begin{aligned} \sin \beta &= \sin(\beta_1 + \beta_2) \\ &= \sin \beta_1 \cos \beta_2 + \sin \beta_2 \cos \beta_1 \\ &= \frac{\sinh b_1 \sinh d \cosh a}{\sinh c \cosh d \sinh a} + \frac{\sinh b_2 \sinh d \cosh c}{\sinh a \cosh d \sinh c} \\ &= \frac{\sinh b_1 \sinh d}{\sinh c \sinh a} \cosh b_2 + \frac{\sinh b_2 \sinh d}{\sinh a \sinh c} \cosh b_1 \\ &= \frac{\sinh d}{\sinh a \sinh c} (\sinh b_1 \cosh b_2 + \sinh b_2 \cosh b_1) \\ &= \frac{\sinh d}{\sinh a \sinh c} \sinh(b_1 + b_2) \\ &= \frac{\sinh b \sinh d}{\sinh a \sinh c}. \end{aligned}$$

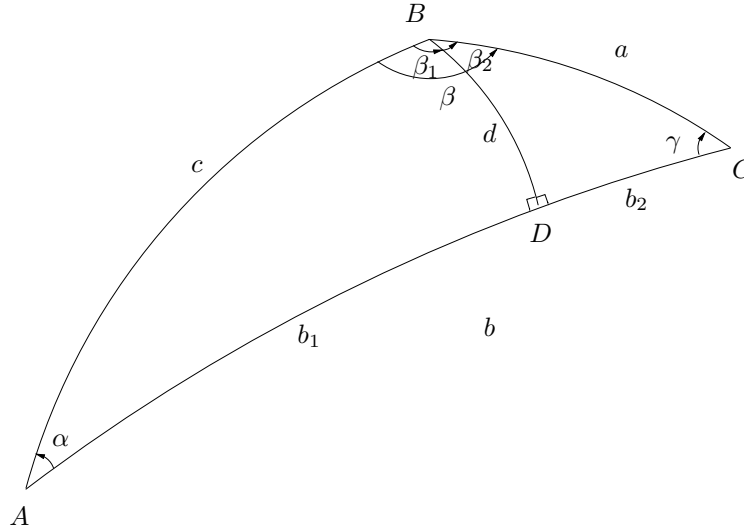

Figure 30.5: The sine rule

Using Proposition 8.2.1 again, we see that $\sin \alpha = \sinh d / \sinh c$ and $\sin \gamma = \sinh d / \sin a$. Substituting these into the above equality proves the result.

Solution 9.1

γ_1 has one fixed point in \mathbb{H} at $(-3 + i\sqrt{51})/6$ and so is elliptic. γ_2 has fixed points at ∞ and -1 and so is hyperbolic. γ_3 has one fixed point at i and so is elliptic. γ_4 has one fixed point at 0 and so is parabolic.

Solution 9.2

We have

$$\gamma_1(z) = \frac{\frac{2}{\sqrt{13}}z + \frac{5}{\sqrt{13}}}{\frac{-3}{\sqrt{13}}z + \frac{-1}{\sqrt{13}}}, \quad \gamma_2(z) = \frac{\frac{7}{\sqrt{7}}z + \frac{6}{\sqrt{7}}}{\frac{1}{\sqrt{7}}}$$

and γ_3 and γ_4 are already normalised.

Solution 9.3

- (i) Clearly the identity is in $SL(2, \mathbb{R})$. If $A \in SL(2, \mathbb{R})$ is the matrix $(a, b; c, d)$ then A^{-1} has matrix $(d, -b; -c, a)$, which is in $SL(2, \mathbb{R})$. If $A, B \in SL(2, \mathbb{R})$ then $\det AB = \det A \det B = 1$ so that the product $AB \in SL(2, \mathbb{R})$.
- (ii) We show that $SL(2, \mathbb{Z})$ is a subgroup. Clearly the identity is in $SL(2, \mathbb{Z})$. If $A, B \in SL(2, \mathbb{Z})$ then the product matrix AB has entries formed by taking sums and products of the entries of A and B . As the entries of A, B are integers, so are any combination of sums and products of the entries. Hence $AB \in SL(2, \mathbb{Z})$. Finally, we need to check that if $A \in SL(2, \mathbb{Z})$ then so is A^{-1} . This is easy, as if $A = (a, b; c, d)$ then $A^{-1} = (d, -b; -c, a)$, which has integer entries.

Solution 10.1

- (i) Recall that the Möbius transformation γ_1 of \mathbb{H} is conjugate to the Möbius transformation γ_2 of \mathbb{H} if there exists a Möbius transformation $g \in \text{Möb}(\mathbb{H})$ such that $g\gamma_1g^{-1} = \gamma_2$.

Clearly γ is conjugate to itself (take $g = \text{id}$).

If $\gamma_2 = g\gamma_1g^{-1}$ then $\gamma_1 = g^{-1}\gamma_2g$ so that γ_2 is conjugate to γ_1 if γ_1 is conjugate to γ_2 .

If $\gamma_2 = g\gamma_1g^{-1}$ and $\gamma_3 = h\gamma_2h^{-1}$ then $\gamma_3 = (hg)\gamma_1(hg)^{-1}$ so that γ_3 is conjugate to γ_1 .

- (ii) Let γ_1 and γ_2 be conjugate. Write $\gamma_2 = g\gamma_1g^{-1}$ where $g \in \text{Möb}(\mathbb{H})$. Then

$$\begin{aligned}\gamma_1(x) = x &\Leftrightarrow g^{-1}\gamma_2g(x) = x \\ &\Leftrightarrow \gamma_2(g(x)) = g(x)\end{aligned}$$

so that x is a fixed point of γ_1 if and only if $g(x)$ is a fixed point of γ_2 . Hence g maps the set of fixed points of γ_1 to the set of fixed points of γ_2 . As g is a Möbius transformation of \mathbb{H} and therefore a bijection, we see that γ_1 and γ_2 have the same number of fixed points.

Solution 10.2

Let $A = (a_{ij}), B = (b_{ij})$ be two matrices. We first show that $\text{trace}(AB) = \text{trace}(BA)$. Recall that the trace of a matrix is the sum of the diagonal elements. Hence

$$\begin{aligned}\text{trace}(AB) &= \sum_i (AB)_{ii} \\ &= \sum_i \sum_j a_{ij}b_{ji} = \sum_j \sum_i b_{ji}a_{ij} = \sum_j (BA)_{jj} \\ &= \text{trace}(BA)\end{aligned}$$

where $(AB)_{ij}$ denotes the (i, j) th entry of AB .

Let

$$\gamma_1(z) = \frac{a_1z + b_1}{c_1z + d_1}, \quad \gamma_2(z) = \frac{a_2z + b_2}{c_2z + d_2}$$

be two conjugate Möbius transformations of \mathbb{H} . Let

$$A_1 = \begin{pmatrix} a_1 & b_1 \\ c_1 & d_1 \end{pmatrix}, \quad A_2 = \begin{pmatrix} a_2 & b_2 \\ c_2 & d_2 \end{pmatrix},$$

be their corresponding (normalised) matrices. Let g be a Möbius transformation of \mathbb{H} such that $\gamma_1 = g^{-1}\gamma_2g$. Suppose that g has matrix A . By replacing A by $-A$ if necessary, it follows from the remarks in Lecture 10 that $A_1 = A^{-1}A_2A$.

Hence

$$\text{trace}(A_1) = \text{trace}(A^{-1}A_2A) = \text{trace}(A_2AA^{-1}) = \text{trace}(A_2).$$

Hence $\tau(\gamma_1) = \text{trace}(A_1)^2 = \text{trace}(A_2)^2 = \tau(\gamma_2)$.

Solution 10.3

Let $\gamma_1(z) = z + b$ where $b > 0$ and let $\gamma_2(z) = z + 1$. As both γ_1 and γ_2 have fixed

points at ∞ and a conjugacy acts a ‘change of co-ordinates’, we look for a conjugacy from γ_1 to γ_2 that fixes ∞ . We will try $g(z) = kz$ for some (to be determined) $k > 0$. Now $g^{-1}\gamma_1g(z) = g^{-1}\gamma_1(kz) = g^{-1}(kz + b) = z + b/k$. So we choose $k = b$.

Now let $\gamma_1(z) = z - b$ where $b > 0$ and let $\gamma_2(z) = z - 1$. Again, let $g(z) = kz$ for some $k > 0$. Then $g^{-1}\gamma_1g(z) = g^{-1}\gamma_1(kz) = g^{-1}(kz - b) = z - b/k$. So again we choose $k = b$.

Suppose that $\gamma_1(z) = z + 1$ and $\gamma_2(z) = z - 1$ are conjugate. Then there exists $g(z) = (az + b)/(cz + d) \in \text{Möb}(\mathbb{H})$ such that $\gamma_1g(z) = g\gamma_2(z)$. In terms of matrices, this says that

$$\begin{pmatrix} 1 & 1 \\ 0 & 1 \end{pmatrix} \begin{pmatrix} a & b \\ c & d \end{pmatrix} = \pm \begin{pmatrix} a & b \\ c & d \end{pmatrix} \begin{pmatrix} 1 & -1 \\ 0 & 1 \end{pmatrix}.$$

That is,

$$\begin{pmatrix} a + c & b + d \\ c & d \end{pmatrix} = \begin{pmatrix} a & -a + b \\ c & -c + d \end{pmatrix}.$$

Comparing coefficient in the ‘+’ case, we see that $c = 0$ and $d = -a$. Hence $ad - bc = -a^2 < 0$, a contradiction. In the ‘-’ case, we see that $c = 0$, $d = 0$, so that $ad - bc = 0$, again a contradiction. Hence γ_1, γ_2 are not conjugate in $\text{Möb}(\mathbb{H})$.

Solution 11.1

Let $\gamma_1(z) = k_1z$ and $\gamma_2(z) = k_2z$ where $k_1, k_2 \neq 1$. Suppose that γ_1 is conjugate to γ_2 . Then there exists a Möbius transformation of \mathbb{H} , $\gamma(z) = (az + b)/(cz + d)$, such that $\gamma\gamma_1(z) = \gamma_2\gamma(z)$. Explicitly:

$$\frac{ak_1z + b}{ck_1z + d} = k_2 \left(\frac{az + b}{cz + d} \right).$$

Multiplying out and equating coefficients gives

$$ack_1 = ack_1k_2, \quad adk_1 + bc = k_2ad + k_1k_2bc, \quad bd = k_2bd.$$

As $k_2 \neq 1$ the third equation implies that $bd = 0$.

Case 1: $b = 0$. If $b = 0$ then the second equation implies that $adk_1 = adk_2$. So either $k_1 = k_2$ or $ad = 0$. If $ad = 0$ then, as $b = 0$, we have $ad - bc = 0$ so γ is not a Möbius transformation of \mathbb{H} . Hence $k_1 = k_2$.

Case 2: $d = 0$. If $d = 0$ then $bc = bck_1k_2$. So either $k_1k_2 = 1$ or $bc = 0$. If $bc = 0$ then, as $d = 0$, we have $ad - bc = 0$ so γ is not a Möbius transformation of \mathbb{H} . Hence $k_1k_2 = 1$.

Here is a sketch of an alternative method. If $\gamma_1(z) = k_1z$ and $\gamma_2(z) = k_2z$ are conjugate then they have the same trace. The trace of γ_1 is seen in Exercise 11.2 below to be $(\sqrt{k_1} + 1/\sqrt{k_1})^2$, and the trace of γ_2 is $(\sqrt{k_2} + 1/\sqrt{k_2})^2$. Equating these shows (after some manipulation) that $k_1 = k_2$ or $k_1 = 1/k_2$.

Solution 11.2

Let γ be hyperbolic. Then γ is conjugate to a dilation $z \mapsto kz$. Writing this dilation in a normalised form

$$z \mapsto \frac{\frac{k}{\sqrt{k}}z}{\frac{1}{\sqrt{k}}}$$

we see that

$$\tau(\gamma) = \left(\sqrt{k} + \frac{1}{\sqrt{k}} \right)^2.$$

Solution 11.3

Let γ be an elliptic Möbius transformation. Then γ is conjugate (as a Möbius transformation of \mathbb{D}) to the rotation of \mathbb{D} by θ , i.e. γ is conjugate to $z \mapsto e^{i\theta}z$. Writing this transformation in a normalised form we have

$$z \mapsto \frac{e^{i\theta/2}z}{e^{-i\theta/2}},$$

which has trace

$$(e^{i\theta/2} + e^{-i\theta/2})^2 = 4 \cos^2(\theta/2).$$

Hence $\tau(\gamma) = 4 \cos^2(\theta/2)$.

Solution 12.1

Fix $q > 0$ and let

$$\Gamma_q = \left\{ \gamma(z) = \frac{az + b}{cz + d} \mid a, b, c, d \in \mathbb{Z}, b, c \text{ are divisible by } q \right\}.$$

First note that $\text{id} \in \Gamma_q$ (take $a = d = 1, b = c = 0$).

Let $\gamma_1 = (a_1z + b_1)/(c_1z + d_1), \gamma_2 = (a_2z + b_2)/(c_2z + d_2) \in \Gamma_q$. Then

$$\gamma_1\gamma_2(z) = \frac{(a_1a_2 + b_1c_2)z + (a_1b_2 + b_1d_2)}{(c_1a_2 + d_1c_2)z + (c_1b_2 + d_1d_2)}.$$

Now q divides b_1, b_2, c_1, c_2 . Hence q divides $a_1b_2 + b_1d_2$ and $c_1a_2 + d_1c_2$. Hence $\gamma_1\gamma_2 \in \Gamma_q$.

If $\gamma(z) = (az + b)/(cz + d) \in \Gamma_q$ then $\gamma^{-1}(z) = (dz - b)/(-cz + a)$. Hence $\gamma^{-1} \in \Gamma_q$.

Hence Γ_q is a subgroup of $\text{Möb}(\mathbb{H})$.

Solution 12.2

The group generated by $\gamma_1(z) = z + 1$ and $\gamma_2(z) = kz$ ($k \neq 1$) is not a Fuchsian group. Consider the orbit $\Gamma(i)$ of i . First assume that $k > 1$. Then observe that

$$\gamma_2^{-n}\gamma_1^m\gamma_2^n(i) = \gamma_2^{-n}\gamma_1^m(k^n i) = \gamma_2^{-n}(k^n i + m) = i + m/k^n.$$

By choosing n arbitrarily large we see that m/k^n is arbitrarily close to, but not equal to, 0. Hence i is not an isolated point of the orbit $\Gamma(i)$. Hence $\Gamma(i)$ is not discrete. By Proposition 12.5.1, Γ is not a Fuchsian group.

The case where $0 < k < 1$ is similar, but with $\gamma_2^{-n}\gamma_1^m\gamma_2^n$ replaced by $\gamma_2^n\gamma_1^m\gamma_2^{-n}$.

Solution 13.1

See Figure 30.6.

Solution 14.1

(Not examinable—included for interest only!)

Recall that a subset $C \subset \mathbb{H}$ is *convex* if: $\forall z, w \in C, [z, w] \subset C$; that is, the geodesic segment between any two points of C lies inside C .

Let us first show that a half-plane is convex. We first show that the half-plane $H_0 = \{z \in \mathbb{H} \mid \text{Re}(z) > 0\}$ is convex; in fact this is obvious by drawing a picture. Now let H be any half-plane; we have to show that H is convex. Recall that H is defined by a geodesic ℓ of \mathbb{H} and that the group of Möbius transformations of \mathbb{H} acts transitively on geodesics. Hence we can find a Möbius transformation γ of \mathbb{H} that maps the imaginary axis to ℓ . Hence γ maps either H_0 or $\{z \in \mathbb{H} \mid \text{Re}(z) < 0\}$ to H . In the latter case we can first

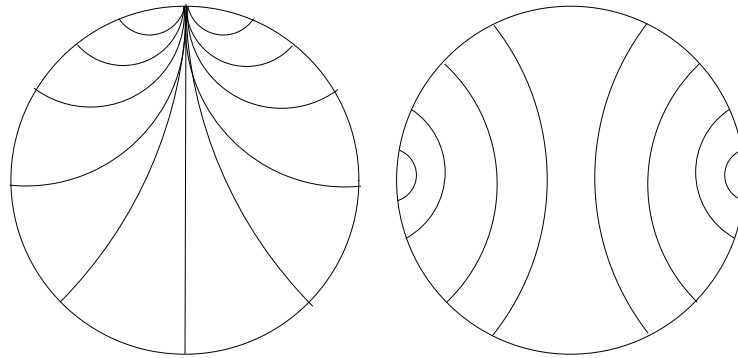

Figure 30.6: Solution to Exercise ex:examplesoftwotessellations

apply the isometry $z \mapsto -\bar{z}$ so that H_0 is mapped by an isometry to H . As isometries map geodesic segments to geodesic segments, we see that H is convex.

Finally, let $D = \cap H_i$ be an intersection of half-planes. Let $z, w \in D$. Then $z, w \in H_i$ for each i . As H_i is convex, the geodesic segment $[z, w] \subset H_i$ for each i . Hence $[z, w] \subset D$ so that D is convex.

Solution 14.2

- (i) By Proposition 14.3.1, $z \in \mathbb{H}$ is on the perpendicular bisector of $[z_1, z_2]$ if and only if $d_{\mathbb{H}}(z, z_1) = d_{\mathbb{H}}(z, z_2)$. Note that

$$\begin{aligned} d_{\mathbb{H}}(z, z_1) = d_{\mathbb{H}}(z, z_2) &\Leftrightarrow \cosh d_{\mathbb{H}}(z, z_1) = \cosh d_{\mathbb{H}}(z, z_2) \\ &\Leftrightarrow 1 + \frac{|z - z_1|^2}{2y_1 \operatorname{Im}(z)} = 1 + \frac{|z - z_2|^2}{2y_2 \operatorname{Im}(z)} \\ &\Leftrightarrow y_2|z - z_1|^2 = y_1|z - z_2|^2. \end{aligned}$$

- (ii) Let $z = x + iy$. Then z is on the perpendicular bisector of $1 + 2i$ and $(6 + 8i)/5$ precisely when

$$\frac{8}{5}|(x + iy) - (1 + 2i)|^2 = 2|(x + iy) - \left(\frac{6}{5} + \frac{8i}{5}\right)|^2,$$

i.e.

$$4((x - 1)^2 + (y - 2)^2) = 5\left(\left(x - \frac{6}{5}\right)^2 + \left(y - \frac{8}{5}\right)^2\right).$$

Expanding this out and collecting like terms gives

$$x^2 - 4x + y^2 = 0$$

and completing the square gives

$$(x - 2)^2 + y^2 = 4 = 2^2.$$

Hence the perpendicular bisector is the semi-circle with centre $(2, 0)$ and radius 2.

Solution 15.1

Let $\Gamma = \{\gamma_n \mid \gamma_n(z) = 2^n z\}$. Let $p = i$ and note that $\gamma_n(p) = 2^n i \neq p$ unless $n = 0$. For each n , $[p, \gamma_n(p)]$ is the arc of imaginary axis from i to $2^n i$. Suppose first that $n > 0$. Recalling that for $a < b$ we have $d_{\mathbb{H}}(ai, bi) = \log b/a$ it is easy to see that the midpoint of $[i, 2^n i]$ is at $2^{n/2} i$. Hence $L_p(\gamma_n)$ is the semicircle of radius $2^{n/2}$ centred at the origin and

$$H_p(\gamma_n) = \{z \in \mathbb{H} \mid |z| < 2^{n/2}\}.$$

For $n < 0$ one sees that

$$H_p(\gamma_n) = \{z \in \mathbb{H} \mid |z| > 2^{n/2}\}.$$

Hence

$$\begin{aligned} D(p) &= \bigcap_{\gamma_n \in \Gamma \setminus \{\text{Id}\}} H_p(\gamma_n) \\ &= \{z \in \mathbb{H} \mid 1/\sqrt{2} < |z| < \sqrt{2}\}. \end{aligned}$$

Solution 16.1

Let $p = i$ and let $\gamma_n(z) = 2^n z$. There are two sides:

$$\begin{aligned} s_1 &= \{z \in \mathbb{C} \mid |z| = 1/\sqrt{2}\}, \\ s_2 &= \{z \in \mathbb{C} \mid |z| = \sqrt{2}\}. \end{aligned}$$

The side s_1 is the perpendicular bisector of $[p, \gamma_{-1}(p)]$. Hence γ_{s_1} , the side-pairing transformation associated to the side s_1 , is

$$\gamma_{s_1}(z) = (\gamma_{-1})^{-1}(z) = 2z$$

and pairs side s_1 to side s_2 . Hence $\gamma_{s_2}(z) = \gamma_{s_1}^{-1}(z) = z/2$.

Solution 17.1

- (i) This follows by observing that running the algorithm starting at $(v, *s)$ is the same as running the algorithm for (v, s) backwards.
- (ii) Starting the algorithm at (v_i, s_i) is the same as starting from the i^{th} stage of the algorithm started at (v_0, s_0) .

Solution 17.2

Suppose the vertices in the elliptic cycle are labelled so that the elliptic vertex cycle is

$$v_0 \rightarrow v_2 \rightarrow \cdots \rightarrow v_{n-1}$$

and the side-pairing transformations are labelled so that the elliptic cycle is given by

$$\gamma_{v_0, s_0} = \gamma_n \gamma_{n-1} \cdots \gamma_1.$$

Suppose that γ_{v_0, s_0} has order $m > 0$.

Now consider the pair (v_i, s_i) . Then the elliptic cycle is given by

$$\begin{aligned} \gamma_{v_i, s_i} &= \gamma_i \gamma_{i-1} \cdots \gamma_1 \gamma_n \cdots \gamma_{i+1} \\ &= (\gamma_i \cdots \gamma_1) \gamma_{v_0, s_0} (\gamma_i \cdots \gamma_1)^{-1}. \end{aligned}$$

Then

$$\begin{aligned} \gamma_{v_i, s_i}^m &= (\gamma_i \cdots \gamma_1) \gamma_{v_0, s_0} (\gamma_i \cdots \gamma_1)^{-1} (\gamma_i \cdots \gamma_1) \gamma_{v_0, s_0} (\gamma_i \cdots \gamma_1)^{-1} \\ &\quad \cdots (\gamma_i \cdots \gamma_1) \gamma_{v_0, s_0} (\gamma_i \cdots \gamma_1)^{-1} \\ &= (\gamma_i \cdots \gamma_1) \gamma_{v_0, s_0}^m (\gamma_i \cdots \gamma_1)^{-1} \\ &= (\gamma_i \cdots \gamma_1) (\gamma_i \cdots \gamma_1)^{-1} \\ &= \text{Id.} \end{aligned}$$

Hence γ_{v_i, s_i} has order m .

Solution 18.1

Let $\Gamma = \langle a, b \mid a^4 = b^2 = (ab)^2 = e \rangle$. First note that $e = a^4 = a^3a$ and $e = b^2 = bb$ so that $a^{-1} = a^3$ and $b^{-1} = b$. Now $e = (ab)^2 = abab$ and multiplying on the left first by a^{-1} and then b^{-1} gives that $ab = ba^3$. (Note that one cannot write $(ab)^2 \neq a^2b^2$.) From this it follows that

$$a^2b = a(ab) = a(ba^3) = (ab)a^3 = ba^3a^3 = ba^6 = ba^2a^4 = ba^2$$

and similarly

$$a^3b = a(a^2b) = a(ba^2) = (ab)a^3 = ba^2a^3 = ba^5 = ba.$$

Now let $w \in \Gamma$ be a finite word in Γ . Then

$$w = a^{n_1} b^{m_1} \cdots a^{n_k} b^{m_k}$$

for suitable integers n_j, m_j . Using the relations $a^4 = b^2 = e$ we can assume that $n_j \in \{0, 1, 2, 3\}$ and $m_j \in \{0, 1\}$. Using the relations we deduced above that $ab = ba^3$, $a^2b = ba^2$ and $a^3b = ba$, we can move all of the a s to the left and all of the b s to the right to see that we can write $w = a^n b^m$ for suitable integers n, m . Again, as $a^4 = b^2 = e$ we can assume that $n \in \{0, 1, 2, 3\}$ and $m \in \{0, 1\}$. Hence there are exactly 8 elements in Γ .

Solution 19.1

Label the sides and vertices of the quadrilateral as in Figure 30.7. Then

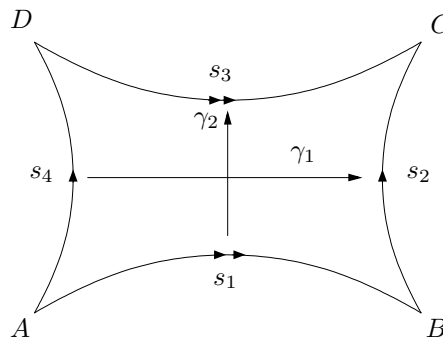

Figure 30.7: A hyperbolic quadrilateral

$$\begin{pmatrix} A \\ s_1 \end{pmatrix} \xrightarrow{\gamma_2} \begin{pmatrix} D \\ s_3 \end{pmatrix} \xrightarrow{*} \begin{pmatrix} D \\ s_4 \end{pmatrix}$$

$$\begin{aligned} \xrightarrow{\gamma_1} & \begin{pmatrix} C \\ s_2 \end{pmatrix} \xrightarrow{*} \begin{pmatrix} C \\ s_3 \end{pmatrix} \\ \xrightarrow{\gamma_2^{-1}} & \begin{pmatrix} B \\ s_1 \end{pmatrix} \xrightarrow{*} \begin{pmatrix} B \\ s_2 \end{pmatrix} \\ \xrightarrow{\gamma_1^{-1}} & \begin{pmatrix} A \\ s_4 \end{pmatrix} \xrightarrow{*} \begin{pmatrix} A \\ s_1 \end{pmatrix}. \end{aligned}$$

Hence the elliptic cycle is $A \rightarrow D \rightarrow C \rightarrow B$ and the corresponding elliptic cycle transformation is $\gamma_1^{-1}\gamma_2^{-1}\gamma_1\gamma_2$.

If we let $\angle A$ denote the internal angle at A , with similar notation for the other vertices, then the angle sum is $\text{sum}(A) = \angle A + \angle B + \angle C + \angle D$.

By Poincaré's Theorem, γ_1, γ_2 generate a Fuchsian group if and only if

$$m(\angle A + \angle B + \angle C + \angle D) = 2\pi$$

for some integer $m \geq 1$.

Solution 20.1

Label the sides as in Figure 30.8. Then

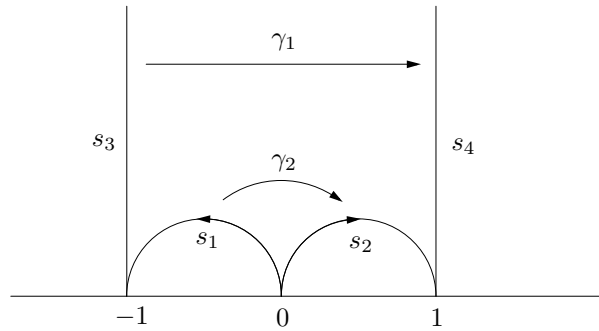

Figure 30.8: A fundamental domain for the free group on 2 generators

$$\begin{aligned} \begin{pmatrix} -1 \\ s_1 \end{pmatrix} & \xrightarrow{\gamma_2} \begin{pmatrix} 1 \\ s_2 \end{pmatrix} \xrightarrow{*} \begin{pmatrix} 1 \\ s_4 \end{pmatrix} \\ & \xrightarrow{\gamma_1^{-1}} \begin{pmatrix} -1 \\ s_3 \end{pmatrix} \xrightarrow{*} \begin{pmatrix} -1 \\ s_1 \end{pmatrix}, \end{aligned}$$

and

$$\begin{pmatrix} \infty \\ s_3 \end{pmatrix} \xrightarrow{\gamma_1} \begin{pmatrix} \infty \\ s_4 \end{pmatrix} \xrightarrow{*} \begin{pmatrix} \infty \\ s_3 \end{pmatrix},$$

and

$$\begin{pmatrix} 0 \\ s_1 \end{pmatrix} \xrightarrow{\gamma_2} \begin{pmatrix} 0 \\ s_2 \end{pmatrix} \xrightarrow{*} \begin{pmatrix} 0 \\ s_1 \end{pmatrix}.$$

Hence there are 3 vertex cycles: $-1 \rightarrow 1$, ∞ and 0 . The corresponding parabolic cycles are: $\gamma_1^{-1}\gamma_2$, γ_1 and γ_2 , respectively.

- $-1 \rightarrow 1$ with corresponding parabolic cycle transformation $\gamma_1^{-1}\gamma_2$,
- ∞ with corresponding parabolic cycle transformation γ_1 ,
- 0 with corresponding parabolic cycle transformation γ_2 .

Clearly γ_1 is parabolic (it is a translation and so has a single fixed point at ∞). The map γ_2 is parabolic; it is normalised and has trace $\tau(\gamma_2) = (1 + 1)^2 = 4$. Finally, the map $\gamma_1^{-1}\gamma_2$ is given by:

$$\gamma_1^{-1}\gamma_2(z) = \gamma_1^{-1}\left(\frac{z}{2z + 1}\right) = \frac{z}{2z + 1} - 2 = \frac{-3z - 2}{2z + 1}$$

which is normalised; hence $\tau(\gamma_1^{-1}\gamma_2) = (-3 + 1)^2 = 4$ so that $\gamma_1^{-1}\gamma_2$ is parabolic.

By Poincaré's Theorem, as all parabolic cycle transformations are parabolic (and there are no elliptic cycles), the group Γ generated by γ_1, γ_2 is a Fuchsian group.

As there are no elliptic cycles, there are no relations. Hence the group is isomorphic to $\langle a, b \rangle$ (take $a = \gamma_1, b = \gamma_2$), which is the free group on 2 generators.

Solution 20.2

- (i) The side-pairing transformation γ_1 is a translation that clearly maps the side $\text{Re}(z) = -(1 + \sqrt{2}/2)$ to the side $\text{Re}(z) = 1 + \sqrt{2}/2$. Hence γ_1 is a side-pairing transformation.

Recall that through any two points of $\mathbb{H} \cup \partial\mathbb{H}$ there exists a unique geodesic. The map γ_2 maps the point $i\sqrt{2}/2$ to itself and the point $-(1 + \sqrt{2}/2)$ to $1 + \sqrt{2}/2$. Hence γ_2 maps the arc of geodesic $[A, B]$ to $[C, B]$. Hence γ_2 is a side-pairing transformation.

- (ii) Let s_1 denote the side $[B, A]$, s_2 denote the side $[B, C]$, s_3 denote the side $[C, \infty]$ and s_4 denote the side $[A, \infty]$.

Now

$$\begin{pmatrix} B \\ s_1 \end{pmatrix} \xrightarrow{\gamma_2} \begin{pmatrix} B \\ s_2 \end{pmatrix} \xrightarrow{*} \begin{pmatrix} B \\ s_1 \end{pmatrix}.$$

Hence we have an elliptic cycle $\mathcal{E} = B$ with elliptic cycle transformation γ_2 and corresponding angle sum $\text{sum}(\mathcal{E}) = \angle B = \pi/2$. As $4\pi/2 = 2\pi$, the elliptic cycle condition holds with $m_{\mathcal{E}} = 4$.

Now consider the following parabolic cycle:

$$\begin{pmatrix} \infty \\ s_4 \end{pmatrix} \xrightarrow{\gamma_1} \begin{pmatrix} \infty \\ s_3 \end{pmatrix} \xrightarrow{*} \begin{pmatrix} \infty \\ s_4 \end{pmatrix}.$$

Hence we have a parabolic cycle $\mathcal{P}_1 = \infty$ with parabolic cycle transformation γ_1 . As γ_1 is a translation, it must be parabolic (recall that all parabolic Möbius transformations of \mathbb{H} are conjugate to a translation). Hence the parabolic cycle condition holds.

Finally, we have the parabolic cycle:

$$\begin{aligned} \begin{pmatrix} A \\ s_4 \end{pmatrix} &\xrightarrow{\gamma_1} \begin{pmatrix} C \\ s_3 \end{pmatrix} \xrightarrow{*} \begin{pmatrix} C \\ s_2 \end{pmatrix} \\ &\xrightarrow{\gamma_2^{-1}} \begin{pmatrix} A \\ s_1 \end{pmatrix} \xrightarrow{*} \begin{pmatrix} A \\ s_4 \end{pmatrix}. \end{aligned}$$

Hence we have a parabolic cycle $\mathcal{P}_2 = A \rightarrow C$ with parabolic cycle transformation: $\gamma_2^{-1}\gamma_1$. Now $\gamma_2^{-1}\gamma_1$ has the matrix

$$\begin{pmatrix} \sqrt{2}/2 & 1/2 \\ -1 & \sqrt{2}/2 \end{pmatrix} \begin{pmatrix} 1 & 2 + \sqrt{2} \\ 0 & 1 \end{pmatrix} = \begin{pmatrix} \sqrt{2}/2 & \sqrt{2} + 1 \\ -1 & -2 - \sqrt{2}/2 \end{pmatrix}$$

which is normalised. Hence the trace of $\gamma_2^{-1}\gamma_1$ is

$$\left(\frac{\sqrt{2}}{2} - 2 - \frac{\sqrt{2}}{2}\right)^2 = 4.$$

Using the fact that a Möbius transformation is parabolic if and only if it has trace 4, we see that $\gamma_2^{-1}\gamma_1$ is parabolic. Hence the parabolic cycle condition holds.

By Poincaré’s Theorem, γ_1 and γ_2 generate a Fuchsian group. In terms of generators and relations, it is given by

$$\langle a, b \mid b^4 = e \rangle.$$

(Here we take $a = \gamma_1, b = \gamma_2$. The relation b^4 comes from the fact that the elliptic cycle $\mathcal{E} = B$ has elliptic cycle transformation $\gamma_{\mathcal{E}} = \gamma_2$ with angle sum $\pi/2$. Hence $m_{\mathcal{E}} = 4$. The relation $\gamma_{\mathcal{E}}^{m_{\mathcal{E}}}$ is then b^4 .)

Solution 21.1

- (i) First note that one side of the polygon is paired with itself. Introduce a new vertex at the mid-point of this side, introducing two new sides each of which is paired with the other. Label the polygon as in Figure 30.9.

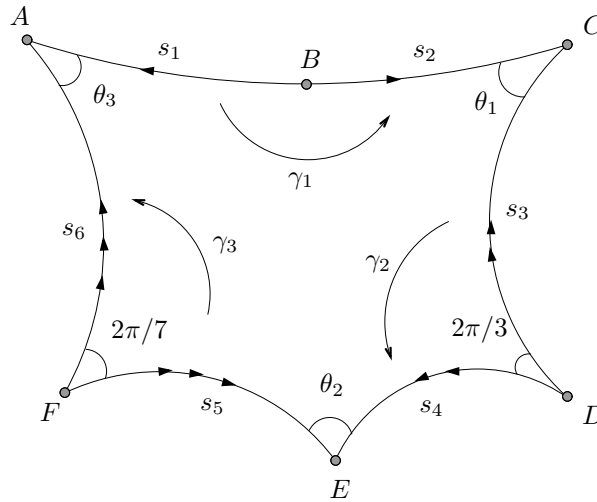

Figure 30.9: Labelling the hyperbolic polygon, remembering to add an extra vertex to the side that is paired with itself

Then

$$\begin{pmatrix} B \\ s_1 \end{pmatrix} \xrightarrow{\gamma_1} \begin{pmatrix} B \\ s_2 \end{pmatrix} \xrightarrow{*} \begin{pmatrix} B \\ s_1 \end{pmatrix}.$$

This gives an elliptic cycle $\mathcal{E}_1 = B$ with elliptic cycle transformation γ_1 and angle sum $\text{sum}(\mathcal{E}_1) = \pi$. Hence the elliptic cycle condition holds with $m_1 = 2$.

We also have

$$\begin{pmatrix} D \\ s_3 \end{pmatrix} \xrightarrow{\gamma_2} \begin{pmatrix} D \\ s_4 \end{pmatrix} \xrightarrow{*} \begin{pmatrix} D \\ s_3 \end{pmatrix}.$$

This gives an elliptic cycle $\mathcal{E}_2 = D$ with elliptic cycle transformation γ_2 and angle sum $\text{sum}(\mathcal{E}_2) = 2\pi/3$. Hence the elliptic cycle condition holds with $m_1 = 3$.

Also

$$\begin{pmatrix} F \\ s_5 \end{pmatrix} \xrightarrow{\gamma_3} \begin{pmatrix} F \\ s_6 \end{pmatrix} \xrightarrow{*} \begin{pmatrix} F \\ s_5 \end{pmatrix}.$$

This gives an elliptic cycle $\mathcal{E}_3 = F$ with elliptic cycle transformation γ_3 and angle sum $\text{sum}(\mathcal{E}_3) = 2\pi/7$. Hence the elliptic cycle condition holds with $m_1 = 7$.

Finally

$$\begin{aligned} \begin{pmatrix} A \\ s_1 \end{pmatrix} &\xrightarrow{\gamma_1} \begin{pmatrix} C \\ s_2 \end{pmatrix} \xrightarrow{*} \begin{pmatrix} C \\ s_3 \end{pmatrix} \\ &\xrightarrow{\gamma_2} \begin{pmatrix} E \\ s_4 \end{pmatrix} \xrightarrow{*} \begin{pmatrix} E \\ s_5 \end{pmatrix} \\ &\xrightarrow{\gamma_3} \begin{pmatrix} A \\ s_6 \end{pmatrix} \xrightarrow{*} \begin{pmatrix} A \\ s_1 \end{pmatrix}. \end{aligned}$$

This gives an elliptic cycle $\mathcal{E}_4 = A \rightarrow C \rightarrow E$ with elliptic cycle transformation $\gamma_3\gamma_2\gamma_1$. The angle sum is $\text{sum}(\mathcal{E}_3) = \theta_1 + \theta_2 + \theta_3 = 2\pi$. Hence the elliptic cycle condition holds with $m_4 = 1$. Hence \mathcal{E}_4 is an accidental cycle.

- (ii) By Poincaré’s Theorem, $\gamma_1, \gamma_2, \gamma_3$ generate a Fuchsian group Γ . In terms of generators and relations we can write

$$\Gamma = \langle a, b, c \mid a^2 = b^3 = c^7 = abc = e \rangle.$$

- (iii) To calculate the genus of \mathbb{H}/Γ we use Euler’s formula $2 - 2g = V - E + F$. Recall that each elliptic cycle on the polygon glues together to give one vertex on a triangulation of \mathbb{H}/Γ . As there are 4 elliptic cycles we have $V = 4$. Each pair of paired sides in the polygon glue together to give one edge on a triangulation of \mathbb{H}/Γ . As there are 6 sides in the polygon, there are $E = 6/2 = 3$ edges in the trinagulation of \mathbb{H}/Γ . As we are only using 1 polygon, there is $F = 1$ face of the triangulation of \mathbb{H}/Γ . Hence $2 - 2g = V - E + F = 4 - 3 + 1 = 2$, so that $g = 0$.

As the orders of the non-accidental elliptic cycles are 2, 3, 7, we see that $\text{sig}(\Gamma) = (0; 2, 3, 7)$.

Solution 21.2

From Exercise 7.3, we know that there exists a regular hyperbolic n -gon with internal angle θ provided $(n - 2)\pi - 8\theta > 0$. When $n = 8$, this rearranges to $\theta \in [0, 3\pi/4)$.

Label the vertices of the octagon as indicated in Figure 30.10.

We have

$$\begin{aligned} \begin{pmatrix} v_1 \\ s_1 \end{pmatrix} &\xrightarrow{\gamma_1} \begin{pmatrix} v_4 \\ s_3 \end{pmatrix} \xrightarrow{*} \begin{pmatrix} v_4 \\ s_4 \end{pmatrix} \\ &\xrightarrow{\gamma_2} \begin{pmatrix} v_3 \\ s_2 \end{pmatrix} \xrightarrow{*} \begin{pmatrix} v_3 \\ s_3 \end{pmatrix} \\ &\xrightarrow{\gamma_1^{-1}} \begin{pmatrix} v_2 \\ s_1 \end{pmatrix} \xrightarrow{*} \begin{pmatrix} v_2 \\ s_2 \end{pmatrix} \end{aligned}$$

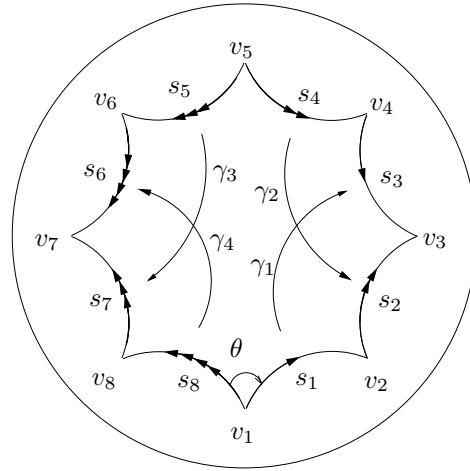

Figure 30.10: See the solution to Exercise 21.2

$$\begin{aligned}
 \xrightarrow{\gamma_2^{-1}} & \begin{pmatrix} v_5 \\ s_4 \end{pmatrix} \xrightarrow{*} \begin{pmatrix} v_5 \\ s_5 \end{pmatrix} \\
 \xrightarrow{\gamma_3} & \begin{pmatrix} v_8 \\ s_7 \end{pmatrix} \xrightarrow{*} \begin{pmatrix} v_8 \\ s_8 \end{pmatrix} \\
 \xrightarrow{\gamma_4} & \begin{pmatrix} v_7 \\ s_6 \end{pmatrix} \xrightarrow{*} \begin{pmatrix} v_7 \\ s_7 \end{pmatrix} \\
 \xrightarrow{\gamma_3^{-1}} & \begin{pmatrix} v_6 \\ s_5 \end{pmatrix} \xrightarrow{*} \begin{pmatrix} v_6 \\ s_6 \end{pmatrix} \\
 \xrightarrow{\gamma_4^{-1}} & \begin{pmatrix} v_1 \\ s_8 \end{pmatrix} \xrightarrow{*} \begin{pmatrix} v_1 \\ s_1 \end{pmatrix}.
 \end{aligned}$$

Thus there is just one elliptic cycle:

$$\mathcal{E} = v_1 \rightarrow v_4 \rightarrow v_3 \rightarrow v_2 \rightarrow v_5 \rightarrow v_8 \rightarrow v_7 \rightarrow v_6.$$

with associated elliptic cycle transformation:

$$\gamma_4^{-1} \gamma_3^{-1} \gamma_4 \gamma_3 \gamma_2^{-1} \gamma_1^{-1} \gamma_2 \gamma_1$$

As the internal angle at each vertex is θ , the angle sum is 8θ . Hence the elliptic cycle condition holds whenever there exists an integer $m = m_{\mathcal{E}}$ such that $8m\theta = 2\pi$, i.e. whenever $\theta = \pi/4m$ for some integer m . When $m = 1$ this is an accidental cycle.

Let θ be such that $\theta = \pi/4m$ for some integer m . Then by Poincaré's Theorem, the group $\Gamma_{\pi/4m}$ generated by the side-pairing transformations $\gamma_1, \dots, \gamma_4$ generate a Fuchsian group. Moreover, we can write this group in terms of generators and relations as follows:

$$\Gamma_{\pi/4m} = \langle \gamma_1, \gamma_2, \gamma_3, \gamma_4 \mid (\gamma_4^{-1} \gamma_3^{-1} \gamma_4 \gamma_3 \gamma_2^{-1} \gamma_1^{-1} \gamma_2 \gamma_1)^m = e \rangle.$$

The quotient space $\mathbb{H}/\Gamma_{\pi/4m}$ is a torus of genus 2. When $m = 1$, $\text{sig}(\Gamma_{\pi/4}) = (2, -)$ and $\mathbb{H}/\Gamma_{\pi/4}$ has no marked points. When $m \geq 2$ then $\text{sig}(\Gamma_{\pi/4}) = (2, m)$ and $\mathbb{H}/\Gamma_{\pi/4m}$ has one marked point of order m .

Solution 21.3

- (i) Consider the Dirichlet polygon and side-pairing transformations for the modular group that we constructed in Lecture 15. See Figure 30.11. The sides s_1 and s_2

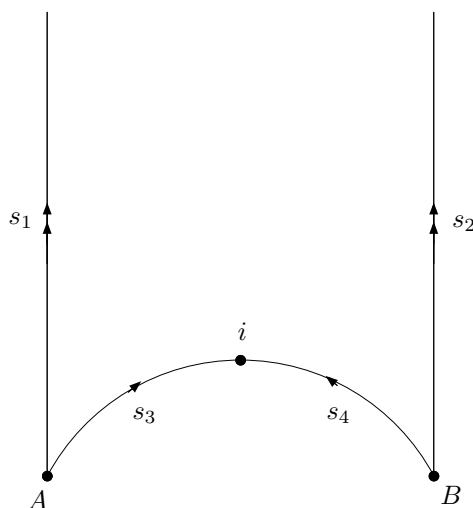

Figure 30.11: A fundamental domain and side-pairing transformations for the modular group

are paired. This gives one cusp at the point ∞ .

There are two elliptic cycles: $A \rightarrow B$ (which has an angle sum of $2\pi/3$), and i (which has an angle sum of π). Hence when we glue together the vertices A and B we get a marked point of order 3, and the vertex i gives a marked point of order 2.

We do not get any ‘holes’ when we glue together the sides. Hence we have genus 0.

Thus the modular group has signature $(0; 2, 3; 1)$.

- (ii) By Proposition 13.2.1 it is sufficient to prove that the formula holds for a Dirichlet polygon D . Suppose that D has n vertices (hence n sides).

We use the Gauss-Bonnet Theorem (Theorem 7.2.1). By Proposition 17.3.1, the angle sum along the j^{th} non-accidental elliptic cycle \mathcal{E}_j is

$$\text{sum}(\mathcal{E}_j) = \frac{2\pi}{m_j}.$$

Hence the sum of the interior angles of vertices on non-accidental elliptic cycles is

$$\sum_{j=1}^r \frac{2\pi}{m_j}.$$

Suppose that there are s accidental cycles. (Recall that a cycle is said to be *accidental* if the corresponding elliptic cycle transformation is the identity, and in particular has order 1.) By Proposition 17.3.1, the internal angle sum along an accidental cycle is 2π . Hence the internal angle sum along all accidental cycles is $2\pi s$.

Suppose that there are c parabolic cycles. The angle sum along a parabolic cycle must be zero (the vertices must be on the boundary, and the angle between two geodesics that intersect on the boundary must be zero).

As each vertex belongs to either a non-accidental elliptic cycle, to an accidental cycle or to a parabolic cycle, the sum of all the internal angles of D is given by

$$2\pi \left(\sum_{j=1}^r \frac{1}{m_j} + s \right).$$

By the Gauss-Bonnet Theorem, we have

$$\text{Area}_{\mathbb{H}}(D) = (n-2)\pi - 2\pi \left(\sum_{j=1}^r \frac{1}{m_j} + s \right). \quad (30.4)$$

Consider now the space \mathbb{H}/Γ . This is formed by taking D and glueing together paired sides. The vertices along each elliptic cycle, accidental cycle and parabolic cycle are glued together to form a vertex in \mathbb{H}/Γ . Hence the number of vertices in \mathbb{H}/Γ is equal to the number of cycles (elliptic, accidental and parabolic); hence D corresponds to a triangulation of \mathbb{H}/Γ with $V = r + s + c$ vertices. As paired sides are glued together, there are $E = n/2$ edges. Finally, as we only need the single polygon D , there is only $F = 1$ face. Hence

$$2 - 2g = \chi(\mathbb{H}/\Gamma) = r + s + c - \frac{n}{2} + 1$$

which rearranges to give

$$n - 2 = 2((r + s + c) - (2 - 2g)). \quad (30.5)$$

Substituting (30.5) into (30.4) we see that

$$\begin{aligned} \text{Area}_{\mathbb{H}}(D) &= 2\pi \left(r + s + c - (2 - 2g) - \sum_{j=1}^r \frac{1}{m_j} - s \right) \\ &= 2\pi \left((2g - 2) + \sum_{j=1}^r \left(1 - \frac{1}{m_j} \right) + c \right). \end{aligned}$$

(iii) We must show that

$$(2g - 2) + \sum_{j=1}^r \left(1 - \frac{1}{m_j} \right) + c \geq \frac{1}{6}. \quad (30.6)$$

We assume that $c \geq 1$.

If $g \geq 1$ then $2g - 2 + c \geq 1 > 1/6$, so that (30.6) holds. So it remains to check the cases when $g = 0$.

If $g = 0$ and $c \geq 2$ then $2g - 2 + c \geq 0$. As $1 - 1/m_j \geq 1/2$, it follows that the left-hand side of (30.6) is at least $1/2$. Hence (30.6) holds. So it remains to check the cases when $g = 0$ and $c = 1$.

If $g = 0$ and $c = 1$ then $2g - 2 + c = -1$. As $m_j \geq 2$, we see that $1 - 1/m_j \geq 1/2$. Hence if $r \geq 3$ then the left-hand side of (30.6) is at least $1/2$. Hence (30.6) holds. It remains to check that case when $g = 0$, $c = 1$ and $r = 2$.

In this case, it remains to check that

$$s(k, l) = 1 - \frac{1}{k} - \frac{1}{l} \geq \frac{1}{6}$$

(letting $k = m_1, l = m_2$). We may assume that $k \leq l$. Now $s(3, 3) = 1/3 > 1/6$ and $s(3, l) \geq 1/3$ for $l \geq 3$. Hence we may assume that $k = 2$. Then $s(2, 2) = 0$, $s(2, 3) = 1/6$ and $s(2, l) > 1/6$. Hence the minimum is achieved for $k = 2, l = 3$.

Hence the minimum is achieved for a Fuchsian group with signature $(0; 2, 3; 1)$. By part (i), this is the signature of the modular group.

Solution 23.1

Let (X, d) be a metric space and suppose that $K \subset X$ is compact and $F \subset K$ is closed. We show F is compact. Let $x_n \in F$ be a sequence; we have to show that x_n has a subsequence that converges to a limit in F . As $F \subset K$, we have $x_n \in K$. As K is compact, there exists a subsequence $x_{n_j} \rightarrow x \in K$. As $x_{n_j} \in F$ and F is closed, Proposition 23.2.2 shows that $x \in F$. Hence F is compact.

Solution 23.2

Let (X, d) be a metric space and suppose that $\gamma : X \rightarrow X$ is an isometry. Let $x \in X$. Let $\varepsilon > 0$ and choose $\delta = \varepsilon$. Then if $d(x, y) < \delta$ we have that $d(\gamma(x), \gamma(y)) = d(x, y) \leq \delta = \varepsilon$. Hence γ is continuous at x . Hence γ is continuous as x is arbitrary.

Solution 23.3

We prove (i) implies (ii). If Y is discrete then every point is isolated. Hence if $x \in Y$, there exists $\varepsilon > 0$ such that $B_\varepsilon(x) \cap Y = \{x\}$. Suppose that $x_n \in Y$ is such that $x_n \rightarrow x$. Then there exists N such that if $n \geq N$ then $d(x_n, x) < \varepsilon$, i.e. $x_n \in B_\varepsilon(x)$. Hence $x_n = x$ if $n \geq N$.

We prove (ii) implies (i). Suppose that (ii) holds but that Y is not discrete. Then there exists $x \in Y$ and a sequence $\varepsilon_n \rightarrow 0$ such that there exists $x_n \in B_{\varepsilon_n}(x)$ but $x_n \neq x$. The sequence x_n converges to x , but $x_n \neq x$; this contradicts (ii).

Solution 23.4

Let $x \in X$, Γ a group of homeomorphisms acting on X , and let $\text{Stab}_\Gamma(x) = \{\gamma \in \Gamma \mid \gamma(x) = x\}$. Clearly $\text{id} \in \text{Stab}_\Gamma(x)$. Let $\gamma_1, \gamma_2 \in \text{Stab}_\Gamma(x)$. Then $\gamma_1\gamma_2(x) = \gamma_1(\gamma_2(x)) = \gamma_1(x) = x$, so that $\gamma_1\gamma_2 \in \text{Stab}_\Gamma(x)$. Finally, suppose that $\gamma \in \text{Stab}_\Gamma(x)$. Then $\gamma^{-1}(x) = x$ if and only if $\gamma(x) = x$. Hence $\gamma^{-1} \in \text{Stab}_\Gamma(x)$. Hence $\text{Stab}_\Gamma(x)$ is a subgroup.

Solution 23.5

Let $\Gamma = \text{Möb}(\mathbb{H})$ be the group of all Möbius transformations of \mathbb{H} . Clearly, $\Gamma(i) = \{\gamma(i) \mid \gamma \in \text{Möb}(\mathbb{H})\}$ is equal to \mathbb{H} ; this is immediate from the fact that we can move the point i to any other point of \mathbb{H} by using a Möbius transformation of \mathbb{H} .

Let $\gamma \in \text{Stab}_\Gamma(i)$. Write

$$\gamma(z) = \frac{az + b}{cz + d}, \quad a, b, c, d \in \mathbb{R}, \quad ad - bc = 1.$$

Then $\gamma(i) = i$ implies that $(ai + b)/(ci + d) = i$, equivalently $ai + b = -c + di$. Comparing coefficients we have that $a = d$ and $b = -c$. Substituting this into $ad - bc = 1$ we have that $a^2 + b^2 = 1$. Hence we can choose $\theta \in [0, 1]$ such that $a = \cos 2\pi\theta$, $b = \sin 2\pi\theta$. Hence

$$\gamma(z) = \frac{\cos(2\pi\theta)z + \sin(2\pi\theta)}{-\sin(2\pi\theta)z + \cos(2\pi\theta)}.$$

Hence $\text{Stab}_\Gamma(i)$ is the group of Möbius transformations of \mathbb{H} that are ‘rotations’ around i .

Solution 23.6

Let $\Gamma = \text{PSL}(2, \mathbb{Z})$. Let $\gamma \in \text{Stab}_\Gamma(i)$ and write $\gamma(z) = (az + b)/(cz + d)$, $a, b, c, d \in \mathbb{Z}$, $ad - bc = 1$. Then $\gamma(i) = i$ implies that $(ai + b)/(ci + d) = i$, equivalently $ai + b = -c + di$. Comparing coefficients we have that $a = d$ and $b = -c$. Substituting this into $ad - bc = 1$ we have that $a^2 + b^2 = 1$. As a and b are integers, we must have that either $a = \pm 1$ and $b = 0$ or $a = 0$ and $b = \pm 1$. Hence $\gamma(z) = z$ or $-1/z$. Hence $\text{Stab}_\Gamma(i) = \{\text{id}, z \mapsto -1/z\}$.

Solution 23.7

Let $\Gamma = \text{PSL}(2, \mathbb{Z})$. Let $b/d \in \mathbb{Q}$ with $b, d \in \mathbb{Z}$, $d \neq 0$ and b, d coprime. By the Euclidean algorithm, there exist integers a, c such that $ad - bc = 1$. Let $\gamma(z) = (az + b)/(cz + d)$. Then $\gamma(0) = b/d$. Clearly if $\gamma(z) = -1/z$ then $\gamma(0) = \infty$. Hence $\Gamma(0) = \mathbb{Q} \cup \{\infty\}$.

- (i) Let $K = [0, 1] \subset \partial\mathbb{H}$ and let $x = 0$. Then $\{\gamma \in \Gamma \mid \gamma(x) \in K\}$ is clearly infinite as, by the observation above, for any $b/d \in \mathbb{Q} \cap [0, 1]$ it contains a transformation of the form $(az + b)/(cz + d)$ with $a, b, c, d \in \mathbb{Z}$, $ad - bc = 1$ and b, d coprime. There are infinitely many such b, d .
- (ii) The orbit $\Gamma(0) = \mathbb{Q} \cup \{\infty\}$ is not a discrete subset of $\partial\mathbb{H}$.
- (iii) Let $\gamma \in \text{Stab}_\Gamma(0)$ and write $\gamma(z) = (az + b)/(cz + d)$ with $a, b, c, d \in \mathbb{Z}$ and $ad - bc = 1$. Then $\gamma(0) = 0$ implies that $b = 0$. Hence $ad = 1$ and without loss of generality we can take $a = d = 1$. Hence

$$\text{Stab}_\Gamma(0) = \left\{ \gamma(z) = \frac{z}{cz + 1} \mid c \in \mathbb{Z} \right\}$$

and this set is infinite.

Solution 23.8

As a straightforward counter-example to ‘compact intersect discrete is finite’, consider $K = [0, 1] \subset \mathbb{R}$, $D = \{1/n \mid n \in \mathbb{N}\}$. Then K is compact and D is discrete, but $K \cap D = D$ is infinite.

- (i) Consider $X = \partial\mathbb{H}$. Let $\Gamma = \{\gamma_n \mid \gamma_n(x) = 2^n x, n \in \mathbb{Z}\}$ (with $\gamma_n(\infty) = \infty$). Then Γ acts by homeomorphisms on $\partial\mathbb{H}$. Consider $K = [0, 1]$; this is compact. Clearly $\Gamma(1) = \{2^n \mid n \in \mathbb{Z}\}$ and this set is discrete. Hence $K \cap \Gamma(1) = \{1, 1/2, 1/4, \dots, 1/2^n, \dots\}$, which is infinite.

(As an aside, note that this example shows that whilst a group of Möbius transformations can act properly discontinuously on \mathbb{H} , it need not act properly discontinuously on $\partial\mathbb{H}$.)

- (ii) As $\Gamma(x)$ is discrete, choose $\varepsilon > 0$ such that $B_\varepsilon(x) \cap \Gamma(x) = \{x\}$. We claim that, for all $\gamma \in \Gamma$, we have $B_\varepsilon(\gamma(x)) \cap \Gamma(x) = \{\gamma(x)\}$. Let $y \in B_\varepsilon(\gamma(x)) \cap \Gamma(x)$. As $y \in \Gamma(x)$ we can write $y = g(x)$ for some $g \in \Gamma$. As $y = g(x) \in B_\varepsilon(\gamma(x))$ we have that

$$d(\gamma^{-1}g(x), x) = d(g(x), \gamma(x)) = d(y, \gamma(x)) < \varepsilon.$$

Clearly $\gamma^{-1}g(x) \in \Gamma(x)$. Hence $\gamma^{-1}g(x) \in B_\varepsilon(x) \cap \Gamma(x)$, and it follows that $\gamma^{-1}g(x) = x$. Hence $y = g(x) = \gamma(x)$ so that $B_\varepsilon(\gamma(x)) \cap \Gamma(x) = \{\gamma(x)\}$.

(iii) Suppose that $\Gamma(x)$ is discrete and let $\varepsilon > 0$ be as in (ii). First note that if $\gamma_1(x) \neq \gamma_2(x)$ then $d(\gamma_1(x), \gamma_2(x)) \geq \varepsilon$. (To see this, if $d(\gamma_1(x), \gamma_2(x)) < \varepsilon$ then $\gamma_2(x) \in B_\varepsilon(\gamma_1(x)) \cap \Gamma(x)$ so that $\gamma_2(x) = \gamma_1(x)$, a contradiction.)

Suppose for a contradiction that $K \cap \Gamma(x)$ is infinite. Choose distinct elements $\gamma_n(x) \in K \cap \Gamma(x)$ with $\gamma_n(x) \neq \gamma_m(x)$, $n \neq m$. As $\gamma_n(x) \in K$ and K is compact, there is a convergent subsequence. As convergent sequences are Cauchy sequences, it follows that we can find distinct element $\gamma_n(x), \gamma_m(x)$ such that $d(\gamma_n(x), \gamma_m(x)) < \varepsilon$, a contradiction.

Solution 24.1

Let $X = \mathbb{R}^3$ and let $\Gamma = \{\text{id}, \gamma_1, \gamma_2, \gamma_3\}$ where $\gamma_1, \gamma_2, \gamma_3$ rotate X around the z -axis through angles 90, 180 and 270 degrees respectively. Note that every point on the z -axis is fixed under every element of Γ .

It is straightforward to see that Γ acts properly discontinuously. Let $\mathbf{x} = (x, y, z) \in \mathbb{R}^3$. Then $\Gamma(\mathbf{x}) = \{\mathbf{x}\}$ if $\mathbf{x} = 0$, and $\Gamma(\mathbf{x})$ are the four corners of a square if $\mathbf{x} \neq 0$. Hence $\Gamma(\mathbf{x})$ is discrete for all $\mathbf{x} \in \mathbb{R}^3$. If $\mathbf{x} \neq 0$ then $\text{Stab}_\Gamma(\mathbf{x}) = \{\text{id}\}$ and if $\mathbf{x} = 0$ then $\text{Stab}_\Gamma(\mathbf{x}) = \Gamma$. Hence $\text{Stab}_\Gamma(\mathbf{x})$ is finite for all $\mathbf{x} \in \mathbb{R}^3$.

Take $p = (0, 0, 0)$ to be the origin in \mathbb{R}^3 . Then p is fixed by every element of Γ . Choose $p_n = (0, 0, z_n)$ where $z_n \rightarrow 0$. Then p_n is also fixed under every element of Γ . Hence any neighbourhood of p contains a point that is fixed under some (indeed, any) non-trivial element of Γ .

(This construction works because, unlike Möbius transformations of \mathbb{H} or \mathbb{D} , it is very easy for an isometry of \mathbb{R}^3 to have a large number—indeed, an entire line—of fixed points.)

Solution 24.2

Take any $z \in \mathbb{H}$. The orbit $\Gamma(z)$ is given by

$$\Gamma(z) = \{z + n \mid n \in \mathbb{Z}\}.$$

As $n \rightarrow \infty$, we have that $z + n \rightarrow \infty$. Similarly, as $n \rightarrow -\infty$, we have that $z + n \rightarrow \infty$. Hence $\Lambda(\Gamma) = \{\infty\}$.

Solution 24.3

Let $\zeta_n \in \Lambda(\Gamma)$ and suppose that $\zeta_n \rightarrow \zeta \in \partial\mathbb{D}$. We have to show that $\zeta \in \Lambda(\Gamma)$. This is clear from drawing a picture; here is how to prove it rigorously.

As $\zeta_n \in \Lambda(\Gamma)$, for each m there exists $\gamma_{n,m} \in \Gamma$ such that

$$|\gamma_{n,m}(z) - \zeta_n| < \frac{1}{m}.$$

Let $\gamma_{(n)} = \gamma_{n,n}$. We show that $\gamma_{(n)}(z) \rightarrow \zeta$ as $n \rightarrow \infty$. Let $\varepsilon > 0$. As $\zeta_n \rightarrow \zeta$, there exists $N_1 \in \mathbb{N}$ such that if $n > N_1$ then $|\zeta_n - \zeta| < \varepsilon$. Choose N_2 such that $1/N_2 < \varepsilon$. Then if $n > \max\{N_1, N_2\}$ we have that

$$\begin{aligned} |\gamma_{(n)}(z) - \zeta| &\leq |\gamma_{n,n}(z) - \zeta_n| + |\zeta_n - \zeta| \\ &\leq 2\varepsilon. \end{aligned}$$

Solution 24.4

We work in the upper half-plane model \mathbb{H} for convenience. Suppose that $\gamma \in \Gamma$ is hyperbolic.

By Proposition 11.2.1, γ is conjugate to the dilation $z \mapsto kz$ for some $k > 1$. That is, there exists $\gamma_1 \in \text{Möb}(\mathbb{H})$ such that $\gamma_1^{-1}\gamma\gamma_1(z) = kz$. Then for any $z \in \mathbb{H}$

$$\gamma_1^{-1}\gamma^n\gamma_1(z) = k^n z \rightarrow \infty \in \partial\mathbb{H}$$

as $n \rightarrow \infty$. Similarly $\gamma_1^{-1}\gamma^n\gamma_1(z) \rightarrow 0$ as $n \rightarrow -\infty$. Hence the limit points of $\gamma_1^{-1}\gamma^n\gamma_1(z)$ are $\{0, \infty\}$, the fixed points of $\gamma_1^{-1}\gamma\gamma_1$. Hence for any $z \in \mathbb{H}$, $\gamma^n(z)$ has limit points equal to the two fixed points.

Solution 24.5

Let $p, q \in \mathbb{Z}$, $q \neq 0$ and let $\gamma(z) = \frac{(1+pq)z - p^2}{q^2z + (1-pq)}$.

First note that the coefficients of γ are integers and that $(1+pq)(1-pq) - (-p^2)q^2 = 1$. Hence $\gamma \in \text{PSL}(2, \mathbb{Z})$.

As $\tau(\gamma) = (1+pq + 1-pq)^2 = 4$, γ is parabolic. Hence the unique fixed point of γ lies in $\Lambda(\text{PSL}(2, \mathbb{Z}))$. By solving the quadratic equation

$$\frac{(1+pq)z - p^2}{q^2z + (1-pq)} = z$$

it is easy to see that the fixed point of γ is at the point p/q . As p, q are arbitrary integers, $\Lambda(\text{PSL}(2, \mathbb{Z}))$ contains \mathbb{Q} . As $\Lambda(\text{PSL}(2, \mathbb{Z}))$ is closed, we must have that $\Lambda(\text{PSL}(2, \mathbb{Z})) = \partial\mathbb{H}$.

Solution 24.6

- (i) Take $\Gamma = \{\text{id}, \gamma\}$ where $\gamma(z) = -1/z$. Take $z = i$. Then the orbit of i is $\Gamma(i) = \{i\}$, which has no limit points on $\partial\mathbb{H}$. Hence $\Lambda(\Gamma) = \emptyset$ and so has zero elements.
- (ii) Take $\Gamma = \{z \mapsto z + n \mid n \in \mathbb{Z}\}$. We saw in Exercise 24.2 that $\Lambda(\Gamma) = \{\infty\}$, which has one element.
- (iii) Take $\Gamma = \{z \mapsto 2^n z \mid n \in \mathbb{Z}\}$. Then, using the argument used in Exercise 24.4, we see that $\Lambda(\Gamma) = \{0, \infty\}$, which has two elements.
- (iv) The limit set of the modular group $\text{PSL}(2, \mathbb{Z})$ is equal to $\partial\mathbb{H}$, which is uncountable and, in particular, infinite.

Solution 25.1

Let $\Gamma = \{\gamma^n \mid n \in \mathbb{Z}\}$. We show that Γ is abelian. This is clear:

$$\gamma^n\gamma^m = \gamma^{n+m} = \gamma^{m+n} = \gamma^m\gamma^n.$$

Solution 25.2

- (i) Let Γ be a discrete subgroup of \mathbb{R} . Clearly $0 \in \Gamma$. Let $a = \inf\{x \in \Gamma \mid x > 0\}$. Then $a > 0$ as otherwise there would exist elements $x_n \in \Gamma$ such that $x_n \rightarrow 0$, contradicting discreteness. Moreover, $a \in \Gamma$. To see this, note that we can find $x_n \in \Gamma$ such that $x_n \rightarrow a$. As Γ is discrete, there exists $N > 0$ such that $x_n = x_m$ for all $n, m \geq N$. Hence $a = x_n$ provided $n \geq N$. Hence $a \in \Gamma$.

The set $\{na \mid n \in \mathbb{Z}\}$ is a subgroup of Γ . We claim that $\Gamma = \{na \mid n \in \mathbb{Z}\}$. Suppose not. Choose $y \in \Gamma$ such that $y \neq na$. We may assume that $y > 0$ (otherwise we consider $-y$). Then there exists an integer k such that $ka < y < (k+1)a$. Hence $y - ka \in \Gamma$ and $0 < y - ka < a$, contradicting the choice of a .

- (ii) Let Γ be a discrete subgroup of $S^1 = \{z \in \mathbb{C} \mid |z| = 1\}$. By discreteness there exists $z = e^{ia} \in \Gamma$ with the smallest argument $a > 0$. Discreteness also implies that $ma = 2\pi$ for some $m \in \mathbb{N}$ (otherwise the sequence $e^{ia}, e^{2ia}, e^{3ia}, \dots$ would be dense in the circle). A similar argument to the above then shows that $\Gamma = \{e^{ika} \mid k = 0, 1, \dots, m-1\}$.

Solution 25.3

Let $g \in C_{\text{Möb}(\mathbb{H})}(\Gamma)$ so that $g\gamma = \gamma g$. Suppose that z is a fixed point of γ , so that $\gamma(z) = z$. Then

$$\gamma(g(z)) = g(\gamma(z)) = g(z)$$

so that $g(z)$ is also a fixed point of γ .

Solution 25.4

- (i) Let $\gamma(z) = kz$, $k \neq 1$, and let $g \in C_{\text{Möb}(\mathbb{H})}(\gamma)$. Write

$$g(z) = \frac{az + b}{cz + d}, \quad ad - bc = 1.$$

Then

$$\gamma g(z) = \frac{kaz + kb}{cz + d}, \quad g\gamma(z) = \frac{akz + b}{ckz + d}.$$

The matrices defining these Möbius transformations have the same trace. Hence we can compare coefficients to see that $kb = \pm b$ (so $b = 0$), $ck = \pm c$ (so $c = 0$). Hence $g(z) = (a/d)z = \lambda z$.

- (ii) Let $\gamma(z) = e^{i\theta}z$ and let $g \in C_{\text{Möb}(\mathbb{H})}(\gamma)$. Write

$$g(z) = \frac{\alpha z + \beta}{\beta z + \bar{\alpha}}$$

where $\alpha, \beta \in \mathbb{C}$, $|\alpha|^2 - |\beta|^2 = 1$. Then

$$\gamma g(z) = \frac{e^{i\theta}\alpha z + e^{i\theta}\beta}{\beta z + \bar{\alpha}}, \quad g\gamma(z) = \frac{\alpha e^{i\theta}z + \beta}{\beta e^{i\theta}z + \bar{\alpha}}.$$

Comparing coefficients shows that $\beta = 0$. Hence g is a rotation.

Solution 25.5

- (i) If $\gamma_1, \gamma_2 \in N_\Gamma(H)$ then

$$(\gamma_1\gamma_2)H(\gamma_1\gamma_2)^{-1} = \gamma_1(\gamma_2H\gamma_2^{-1})\gamma_1^{-1} = \gamma_1H\gamma_1^{-1} = H$$

so that $\gamma_1\gamma_2 \in N_\Gamma(H)$. Clearly if $\gamma \in N_\Gamma(H)$ then $\gamma^{-1} \in N_\Gamma(H)$. Clearly the identity is in $N_\Gamma(H)$.

- (ii) Suppose that $N_{\text{Möb}(\mathbb{H})}(\Gamma)$ is not a Fuchsian group. Then there exists a sequence of distinct elements $\gamma_n \in N_{\text{Möb}(\mathbb{H})}(\Gamma)$ such that $\gamma_n \rightarrow \text{Id}$ but $\gamma_n \neq \text{Id}$.

Let $\gamma \in \Gamma$. Then $\gamma_n \gamma \gamma_n^{-1} \rightarrow \gamma$ as $n \rightarrow \infty$. As $\gamma_n \in N_{\text{Möb}(\mathbb{H})}(\Gamma)$, we see that $\gamma_n \gamma \gamma_n^{-1} \in \Gamma$. As Γ is discrete, there exists $N \in \mathbb{N}$ such that if $n \geq N$ then $\gamma_n \gamma \gamma_n^{-1} = \gamma$. Hence γ_n and γ commute if $n \geq N$. By Proposition 25.2.2, this implies that both γ_n and γ have the same set of fixed points.

As Γ is not abelian, Proposition 25.2.2 implies that there exists $g \in \Gamma$ which has a different set of fixed points to γ .

But the same argument shows that γ_n and g have the same set of fixed points. This is a contradiction.

Solution 26.1

Suppose that Γ is an infinite cyclic group generated by a parabolic element. By replacing Γ with a conjugate subgroup, we may assume that Γ is generated by $z \mapsto z + 1$. The limit set of this Fuchsian group is clearly $\{\infty\}$. Hence the limit set of Γ has one element.

Solution 26.2

Let Γ be a non-elementary group. We claim that Γ contains a hyperbolic element.

Suppose not, i.e. assume that Γ contains only elliptic and parabolic elements.

First note that Γ does not contain only elliptic elements. For if it did, by Proposition 26.1.1 there would exist a common fixed point, and it would follow that $\Lambda(\Gamma) = \emptyset$.

Hence there exists a parabolic element $\gamma_1 \in \Gamma$ with fixed point $\zeta \in \partial\mathbb{H}$. By replacing Γ with a conjugate subgroup we can assume that $\zeta = \infty$ and $\gamma_1(z) = z + 1$ or $\gamma_1(z) = z - 1$. We will assume that $\gamma_1(z) = z + 1$; the case when $\gamma_1(z) = z - 1$ is similar.

As Γ is not elementary, it is not generated by γ_1 . Moreover, suppose Γ contains the translation $z \mapsto z + b$. If b is irrational then γ_1 and $z \mapsto z + b$ do not generate a discrete subgroup. If $b = p/q$ is rational, then both γ_1 and $z \mapsto z + b$ are contained in the elementary subgroup generated by $z \mapsto z + 1/q$.

Hence there exists $\gamma_2 \in \Gamma$ such that γ_2 is not a translation. Write

$$\gamma_2(z) = \frac{az + b}{cz + d}$$

with $a, b, c, d \in \mathbb{R}$ and $ad - bc = 1$.

Suppose that $c = 0$. Then $\gamma_2(z) = (az + b)/d$. If $a \neq d$ then γ_2 is hyperbolic and we are done. If $a = d$ then γ_2 is a translation, and we chose γ_2 so that this does not occur.

Consider $\gamma_2 \gamma_1^n$. Then

$$\gamma_2 \gamma_1^n(z) = \frac{az + (an + b)}{cz + (cn + d)}$$

which has trace

$$\tau(\gamma_2 \gamma_1^n) = (a + d + cn)^2.$$

As $c \neq 0$, by choosing n sufficiently large we see that $\tau(\gamma_2 \gamma_1^n) > 4$. Hence $\gamma_2 \gamma_1^n$ is hyperbolic for n sufficiently large.